



Ahmednagar Jilha Maratha Vidya Prasarak Samaj's

New Arts, Commerce and Science College, Parner

Tal. Parner, Dist. Ahmednagar - 414 302 (Maharashtra)



4th Cycle

Assesment and Accreditation

Criterion-3

Research, Innovations and Extension

KI :3.3- Research Publication and Awards

QnM - 3.3.2

Number of books and chapters in edited volumes/books published and papers published in national/ international conference proceedings per teacher during last five years





 NAAC A Grade Best College Award by SPPRT Parner	Ahmednagar Jilha Maratha Vidya Prasarak Samaj's New Arts, Commerce & Science College	
	• Parner, Dist.- A.nagar, Maharashtra Pin - 414302 • Office (02488) 221537/35	
Affiliated ID. No. PU/AN/ASC/019/1977 College Code No. 121 Email- naspcparcollege2013@gmail.com naspcpar@rediffmail.com Website : www.newartsparner.com	Principal Dr. Rangnath Aher M.Sc., Ph.D., F.H.A.S., F.I.S.S.T. Mob. 9422754080	
Ref. No. NAC&S	Date : 24/ 11 /2022	
<u>DECLARATION</u>		
<p>This is to declare that the information, reports, true copies of the supporting documents, numerical data, etc. submitted/presented in this file is verified by Internal Quality Assurance Cell (IQAC) and is correct as per the records. This declaration is for the purpose of NAAC accreditation of HEI for 4th Cycle period 2017-18 to 2021-22.</p>		
Date: 24/11/2022		
Place: Parner		
 Prof. (Dr.) D. R. Thube IQAC Coordinator IQAC COORDINATOR New Art's,Commerce & Science College Parner, Dist.Ahmednagar		 Dr. R. K. Aher IQAC Chairman and Principal PRINCIPAL New Arts, Commerce & Science College Parner, Tal. Parner, Dist. Ahmednagar

Table of Contents

List of Books, Chapters, and papers in proceedings.....	9
A. List of Books, Chapter published	9
B. List of Articles in Proceedings	27
Books, Chapters Published	47
1. Yoga for Stress Management.....	47
2. Fundamentals of Botany.....	50
3. Sorghum: Water Stress.....	53
4. Introduction to Environmental Biology	54
5. A Study of Indian Ethos: in The Glass Palace of Amithav Ghose	55
6. A Study of Indian Ethos: in The Hungry Tide of Amithav Ghose	56
7. Amitav Ghosh: A Study of Indian Ethos in Sea of Poppies	57
8. Amitav Ghosh: Eine Studie über das indische Ethos im Mohnblumenmeer (German Edition). 58	
9. Amitav Ghosh: Une étude de l'ethos indien dans la mer de pavots (French Edition)	59
10. Amitav Ghosh: Uno studio sull'etica indiana nel mare dei papaveri (Italian Edition)	60
11. Amitav Ghosh: Studiumindyjskiego etosu w morzu maków (Polish Edition)	61
12. Amitav Ghosh: Un estudio del ethos indio en el Mar de Amapolas (Spanish Edition)	62
13. Physical and Human Geography	63
14. Heat and Thermodynamics.....	64
15. Electricity & Magnetism	68
16. Plant Life and Utilization.....	72
17. Concepts in Mammalian Physiology	75
18. CH-103 and 203 Chemistry Practical (CBCS)	76
19. CH-102: Organic Chemistry (CBCS)	79
20. CH-103 and 203 Chemistry Practical (CBCS)	83
21. CH-101 Physical Chemistry (CBCS).....	88
22. CH-103 and 203 Chemistry Practical (CBCS)	91
23. Prakashwata Swarup Ani Chintan	96
24. Aadunik Bharatiy Bhasha : Marathi	108
25. Bhashik Kaushyal Vikas Ani Akankika.....	110
26. Aadunik SahityaPrakar Kandanbari Rarang Dhang	112
27. Bhashik Kaushyal Vikas	114
28. Marathi Sahitya : Katha Ani Bhashik Kaushyal Vikas Ani Akankika Ani Bhashik Kaushyavikas 116	

29.	महाराजा सयाजीराव गायकवाड पत्र संग्रह भाग3-	119
30.	Environmental Geography	121
31.	Economic Geography	123
32.	Geography of Maharashtra (Physical)-I	125
33.	Financial System	127
34.	Mathematical Method in Physics For S.Y.BSc.organic Chemistry (CBCS)	129
35.	Physics, Electronics for S.Y.BSc.	131
36.	Applied Research In Botany	133
37.	CH-302: Inorganic and Organic Chemistry (CBCS).....	138
38.	CH-402: Inorganic and Organic Chemistry (CBCS).....	141
39.	CH-303: Chemistry Practical (CBCS).....	144
40.	CH-302: Inorganic and Organic Chemistry (CBCS).....	148
41.	CH-402: Inorganic and Organic Chemistry (CBCS).....	151
42.	CH-303: Chemistry Practical (CBCS).....	154
43.	Avkali Vilkh: Shetkari Vednecha Hunkar	158
44.	Geography of Disaster Management.....	163
45.	Bhartcha Bhugol	165
46.	Bhartcha Bhugol	166
47.	Gramin Vikasacha Bhugol	167
48.	Quantum Mechanics T.Y.B.Sc.(Sem.-VI)(PHY-362).....	168
49.	Mathematical Methods in Physics-II T.Y.B.Sc.(Sem-V)(PHY-351).....	170
50.	Biodiversity (Fungal Biofertilizer).....	172
51.	Applied Research in Botany Volume-1.....	175
52.	Plant Physiology and Metabolism.....	180
53.	Biofertilizers.....	183
54.	Archegoniate	187
55.	CH-504: Inorganic Chemistry (CBCS).....	189
56.	CH-604: Inorganic Chemistry (CBCS).....	194
57.	CH-503, 506, 509: Chemistry Practical (CBCS)	198
58.	CH-603, 606, 609: Chemistry Practical (CBCS)	203
59.	CH-510B: Polymer Chemistry (CBCS)	209
60.	Introductory Basics of Chemistry.....	212
61.	CH-603, 606, 609: Chemistry Practical (CBCS)	216
Articles in Proceeding (P): 2017-2018 to 2021-2022		222

1.	Prachin Va Madhyayugin Newase	222
2.	Kamgar Chalval Ani Narayan Meghaji Lokhande	231
3.	Prachin Newase	237
4.	Applications of Graph Theory in Science and Technology	246
5.	Challenges Faced in Marketing Branded Products in Rural and Urban Market	253
6.	Strategies for developing Indian Dairy in Changed Global Scenario	262
7.	Application of Graph theory in the digital electronics	273
8.	Nanotechnology for energy applications.....	277
9.	Solar energy and environment	279
10.	Interdisciplinary Application of Mathematics	281
11.	Applications of Graph Theory in Science & Technology.....	282
12.	The Domination in Graph Theory	287
13.	Survey of Graph Energy's.....	291
14.	Application of Graph Theory in Electrical Circuit.	292
15.	Application of Graph theory in combintorics.....	296
16.	Applications of Spectral Theory	297
17.	Application of Graph Theory in Computer Science	310
18.	Applications of Graphs in Real Line	313
19.	Application Of Graph Theory In Daily Human Life	315
20.	Applications of Graph Theory in Science and technology.....	318
21.	Dr. Babasaheb Ambedkar Yanche Shikshan Vishayak Vichar.....	324
22.	Qualitative Research Methodology in social sciences	331
23.	Phase changes under heat treatment during synthesis of Alpha-Al ₂ O ₃ by Sol Gel method 335	
24.	Phototoxicity of nanoparticles on plant growth	336
25.	Synthesis and Characterization of Bismuth Ferrite by Sol gel method	337
26.	Synthesis and Characterization of silica nanoparticles via stober's method.....	339
27.	Effect of Sintering On Zn- Mn Ferrite.....	340
28.	A Comparison of Classification Methods: Naïve Bayes and Support Vector Machine	342
29.	Ramabai Ambedkar yanche Dr. Babasahebanchya Kutumbatil Yogdan	348
30.	Prachin Va Madhyayugin Newase.....	352
31.	Pros & Cons of Indian Nationalism: Is India a Nation.....	361
32.	Contribution of Achievements of Women In Various Field at National & International Levels :- Women are the Real Architect of Society.....	370
33.	Challenges before Service Sector in India	374

34.	Agriculture Sector in India	380
35.	Challenges before the skill development in India	386
36.	Impact of GST on Indian Economy	393
37.	Important Challenges and Prosperous of Indian Economy reference to Agriculture Sector 400	
38.	Introduction To Indian Economy and Problems Faced By It	408
39.	Challenges before Agricultural Sector in India	416
40.	Structural and magnetic characterization of multiferronic Bismuth Ferrite nanoparticles by sol gel method	424
41.	Electrochemical synthesis of CuS thin film for supercapacitor application	426
42.	Synthesis Characterization and Application of ZnO by Mechanochemical method	428
43.	Internet of Things with Blockchain	430
44.	ME output in magnetoelectric composites	433
45.	Optimization of crystal violet Dye for decolorization using Aluminum oxide nanoparticles 434	
46.	Connecting Past With Present Mathematics Education	435
47.	Special Function and Its Multidisciplinary Application	437
48.	Importance of Technology in Mathematics Teaching	438
49.	Strategy of e-marketing Library information	443
50.	Ferrite and Ferroelectric Properties of $(y) \text{BaTiO}_3 + (1-y) \text{Ni}_{0.90}\text{Co}_{0.05}\text{Cu}_{0.05} \text{Fe}_2\text{O}_4$ Composites	447
51.	Characterization of Manganese Substituted Zinc Ferrites (OP 45)	449
52.	Pro 51 - Optimization and Decolorization Of Methylene Blue Dye Using Aluminium Oxide Nanoparticles (OP 88)	451
53.	Graphene: The Wonder Nanomaterial (OP 89)	453
54.	Effects of spent wash on the physico-chemical properties of soil and early seedling growth in fenugreek (<i>Trigonella foenum graecum</i>)	455
55.	Mechano-Chemical Method for Synthesis of Zinc Oxide Nanoparticles	457
56.	Low-Density Teos-based Silica Aerogels Prepared at Supercritical Drying Using Ethanol as the Preparative Solvent	459
57.	Effect Of The Pr (Praseodymium) Substitution On The Structural, Magnetic And Adsorption Properties In Cobalt Ferrite Nanoparticles (OP118)	462
58.	Antifungal activity of <i>vitex nigundo</i> linn. Against some pathogen of <i>allium cepa</i>	465
59.	The Impact of COVID 19 Pandemic On Mathematics Higher Education \.....	466
60.	Interdisciplinary Approach of Graph Theory	472
61.	Application Of Number Theory In Computing/ Cryptography	474

62.	Application of Operational Research To The Transportation Problem	475
63.	Application Of Computational Geometry	476
64.	Uses Of Graph Coloring In Day To Life.	477
65.	Application Of Number Theory In Statistics.....	478
66.	Secure Home doorbell using python and raspberry PI	479
67.	Role of Artificial Intelligence in Human Computer Interaction	487
68.	Multitank Drone Spray using AI	491
69.	Online or Offline: Artificial Intelligence	496

QnM - 3.3.2

Total number of books and chapters in edited volumes/books published:

Year	2017-18	2018-19	2019-20	2020-21	2021-22	Total
Number	04	-	18	20	19	61

Total number of papers in national/ international conference proceedings year wise during last five years:

Year	2017-18	2018-19	2019-20	2020-21	2021-22	Total
Number	20	08	15	05	21	69

List of Books, Chapters, and papers in proceedings

A. List of Books, Chapter published

Sr. No.	Name of Teacher	Title of the Books and Chapter / Title of Paper in Proceeding	Name of Publisher	National / International	ISBN/ ISSN number of Proceedings	Year	Weblink
1.	S. M. Gaikwad	Role of Yoga & Naturopathy to improve Physical & Mental Health (Yoga for Stress Management)	NACSC, Parner	National	978-81-926976-0-4	2017-18	https://drive.google.com/file/d/1RuZqCA2KCTQm_8aYE31Whr4ewlYuV2Gg/view?usp=share_link
2.	R. K. Aher	Fundamentals of Botany	Divya Distributor, Kanpur	National	978-93-80913-29-2	2017-18	https://drive.google.com/file/d/15bFbdhxBluwGOftORHuFw5cbg2xDmJTV/view?usp=share_link
3.	R. N. Deshmukh	Sorghum: Water Stress	Lulu.com 3101, Hillsborough St, Raleigh, NC 27607, United States	International	978-1-387-14155-5	2017-18	https://drive.google.com/file/d/13uSDF7sLXNNd4DvPQtP5IxXx9OpHwils/view?usp=share_link
4.	S. R. Wagh	Introduction to Environmental Biology	Lulu Publications USA	International	978-0-359-96862-6	2017-18	https://assessmentonline.naac.gov.in/storage/app/hei/SSR/14518/3.4.6_1591704408_3787.xlsx

5.	V. Salve	A Study of Indian Ethos: in The Glass Palace of Amithav Ghose	Lambert	International	ISBN 6200435324	2019-20	https://www.perlego.com/book/3383784/a-study-of-indian-ethos-in-the-glass-palace-of-amitav-ghosh-pdf
6.	V. Salve	A Study of Indian Ethos: in The Hungry Tide of Amithav Ghose	Lambert	International	ISBN 6200442525	2019-20	https://isbnsearch.org/isbn/6200442525
7.	V. Salve	Amitav Ghosh : A Study of Indian Ethos in Sea of Poppies	Lambert	International	ISBN 9786202801584	2019-20	https://www.betterworldbooks.com/product/detail/amitav-ghosh-a-study-of-indian-ethos-in-sea-of-poppies-9786202801584
8.	V. Salve	Amitav Ghosh:: Eine Studie über das indische Ethos im Mohnblumenmeer (German Edition)	Verlag Unser Wissen	International	ISBN 9786203109412	2019-20	https://www.amazon.com/Amitav-Ghosh-Studie-indische-Mohnblumenmeer/dp/620310941X
9.	V. Salve	Amitav Ghosh :: Une étude de l'ethos indien dans la mer de pavots (French Edition)	Editions Notre Savoir	International	ISBN 9786203109399	2019-20	https://www.amazon.co.uk/Amitav-Ghosh-l'ethos-indien-pavots/dp/6203109399

10.	V. Salve	Amitav Ghosh:: Uno studio sull'etica indiana nel mare dei papaveri (Italian Edition)	Edizioni Sapienza	International	ISBN 9786203109382	2019-20	https://www.amazon.com/Amitav-Ghosh-sulletica-indiana-papaveri/dp/620310938X
11.	V. Salve	Amitav Ghosh: Studiumindyjskiego etosu w morzu maków (Polish Edition)	Wydawnictwo Nasza Wiedza	International	ISBN 9786203109368	2019-20	https://kniгоzal.com/store/gb/book/amitav-ghosh/isbn/978-620-3-10936-8
12.	V. Salve	Amitav Ghosh: Un estudio del ethos indio en el Mar de Amapolas (Spanish Edition)	Ediciones Nuestro Conocimiento	International	ISBN 9786203109405	2019-20	https://www.amazon.de/Amitav-Ghosh-estudio-ethos-Amapolas/dp/6203109401
13.	R. E. Najan	Physical and Human Geography	Prashant Publications, Jalgaon	National	978-93-88769-78-5	2019-20	https://prashantpublications.com/books/prakritik-v-manavi-bhugol/
14.	S. L. Kadam	Heat and Thermodynamics	Success Publications	-	ISBN-978-93-89739-12-1	2019-20	https://doris.sagepub.in/Heat-and-Thermodynamics---Physics-Paper-I/ebook-details?siteName=books&bookId=32594&preview=true&publisher=Success%20Publication

15.	S. L. Kadam	Electricity & Magnetism	Success Publications	-	ISBN-978-93-89739-13-8	2019-20	https://www.wonderslate.com/Electricity-and-Magnetism---Physics-Paper-II/ebook-details?siteName=books&bookId=32633&publisher=Success-Publication&preview=true
16.	R. K. Aher	Plant Life and Utilization	Success Publication, Pune	-	978-93-89066-35-7	2019-20	https://www.kopykitab.com/Plant-life-And-Utilization-I-by-Dr-B-K-Avchar-Dr-Ashok-R-Tuwar-Dr-Rangnath-Aher-Dr-Nandu-Bhila-Pawar-Dr-Subhash-V-Ahire-Dr-D-N-Patil
17.	S. R. Wagh	Concepts in Mammalian Physiology	Lulu Publications USA	International	ISBN: 978-0-359-96863-3	2019-20	https://drive.google.com/file/d/1SnC6OFp8KDH Fwmddw o3s2-rZQU Ma FF45/view?usp=share_link

18.	D. R. Thube	CH-103 and 203 Chemistry Practical (CBCS)	Nirali Publications	State	978-93-89406-51-1	2019-20	https://pragationline.com/practical-chemistry-7-gagale-nagawade-shinde-thube-natu-bobade-jadhav-pawar-khanwilkar/
19.	T. S. Thopate	CH-102: Organic Chem (CBCS)	Prashant Publications	State	978-93-88769-00-0	2019-20	https://www.kopykitab.com/Organic-Chemistry-SPPU-by-Dr-T-S-Thopate-Dr-S-R-Thopate-Dr-N-R-Dalvi-Dr-D-G-Karpe
20.	T. S. Thopate	CH-103 and 203 Chemistry Practical (CBCS)	Prashant Publications	State	978-93-85664-95-3	2019-20	https://www.kopykitab.com/Practical-Chemistry-by-Prof-Dr-A-M-Nemade-Prof-N-E-Barhate-Dr-M-K-Patel-Dr-V-S-Zope-Dr-S-S-Rajput-Dr-V-T-Patil-Dr-R-G-Mahale-Dr-A-G-Sarode

21.	R. S. Diggikar	CH-101 Physical Chemistry (CBCS)	Prashant Publications	State	978-93-88769-92-1	2019-20	https://www.kopykitab.com/Physical-Chemistry-SPPU-by-Dr-M-F-Shaikh-Dr-R-S-Diggikar-Prof-G-N-Ghudmare-Prof-Miss-D-B-Bharad
22.	R. S. Diggikar	CH-103 and 203 Chemistry Practical (CBCS)	Prashant Publications	State	978-93-85664-95-3	2019-20	https://www.kopykitab.com/Practical-Chemistry-by-Prof-Dr-A-M-Nemade-Prof-N-E-Barhate-Dr-M-K-Patel-Dr-V-S-Zope-Dr-S-S-Rajput-Dr-V-T-Patil-Dr-R-G-Mahale-Dr-A-G-Sarode
23.	H. S. Shelke	Prakashwata Swarup Ani Chintan	Prashant Publication Jalgaon	National	978-93-90483-37-2	2020-21	https://www.kopykitab.com/Prakashwata-Sawarup-Aani-Chintan-by-Pro-Dr-Tushar-Chandwadar

24.	H. S. Shelke	Aadunik Bharatiy Bhasha : Marathi	Prashant Publication Jalgaon	National	978-93-90483-76-1	2020-21	https://prashantpublications.com/books/%E0%A4%86%E0%A4%A7%E0%A5%81%E0%A4%A8%E0%A4%BF%E0%A4%95-%E0%A4%AD%E0%A4%B0%E0%A4%A4%E0%A5%80%E0%A4%A4%E0%A4%AD%E0%A4%B0%E0%A4%B7%E0%A4%B0%E0%A4%AE%E0%A4%B0%E0%A4%BE%E0%A4%A0%E0%A5%80/
-----	--------------	-----------------------------------	------------------------------	----------	-------------------	---------	---

25.	H. S. Shelke	Bhashik Kaushyal Vikas Ani Akankika	Prashant Publication Jalgaon	National	978-93- 89493-49-8	2020-21	https://prashantpublications.com/books/%E0%A4%AD%E0%A4%B0%A4%BE%E0%A4%B7%E0%A4%BF%E0%A4%95-%E0%A4%95%E0%A5%8C%E0%A4%B6%E0%A4%B2%E0%A5%8D%E0%A4%AF-%E0%A4%B5%E0%A4%BF%E0%A4%95%E0%A4%BE%E0%A4%B8/
26.	H. S. Shelke	Aadunik SahityaPrakar Kandanbari Rarang Dhang	Aksharved Publication, Pune	National	978-93- 89493-34-4	2020-21	https://drive.google.com/file/d/1mec2Tmgpmov3Sq0PkoUES08kikYCE8lv/view?usp=share_link
27.	H. S. Shelke	Bhashik Kaushyal Vikas	Aksharved Publication, Pune	National	978-93- 89493-35-1	2020-21	https://drive.google.com/file/d/1R_sXW_vCKpZeJ6WleEiUgcDiaoLEatUr/view?usp=share_link

28.	H. S. Shelke	Marathi Sahitya : Katha Ani Bhashik Kaushyal Vikas Ani Akankika Ani Bhashik Kaushyavikas	Vikas Publishig, Noida, UP	National	978-93- 52717-77-4	2020-21	https://www.kopykitab.com/Marathi-Sahitya-Katha-Aani-Bhashik-Kaushlya-Vikash-by-Sharp-Publications
29.	V.S. Raut	महाराजा सयाजीराव गायकवाड पत्र संग्रह भाग-3	सचिव, महाराजा सयाजीराव गायकवाड चरित्र साधन समिति, औरंगाबाद	National	-	2020-21	https://drambedkarbookcenter.com/shop/aitihasik/%E0%A4%AE%E0%A4%B9%E0%A4%BE%E0%A4%B0%E0%A4%BE%E0%A4%9C%E0%A4%BE-%E0%A4%B8%E0%A4%AF%E0%A4%9C%E0%A5%80%E0%A4%B0%E0%A4%BE%E0%A4%B5-%E0%A4%97%E0%A4%BE%E0%A4%AF%E0%A4%95%E0%A4%B5%E0%A4%BE-5/

30.	R. E. Najan	Environmental Geography	Prashant Publication, Jalgaon	National	978-93-89501-78-0	2020-21	https://prashantpublications.com/books/%E0%A4%AA%E0%A4%B0%E0%A5%8D%E0%A4%AF%E0%A4BE%E0%A4%B5%E0%A4%B0%E0%A4%A3-%E0%A4%AD%E0%A5%82%E0%A4%97%E0%A5%8B%E0%A4%B2-2/
31.	R. E. Najan	Economic Geography	Prashant Publication, Jalgaon	National	978-81-94898-3-3	2020-21	https://prashantpublications.com/books/%E0%A4%86%E0%A4%B0%E0%A5%8D%E0%A4%A5%E0%A4%BF%E0%A4%95-%E0%A4%AD%E0%A5%82%E0%A4%97%E0%A5%8B%E0%A4%B2/

32.	R. E. Najan	Geography of Maharashtra (Physical)-I	Prashant Publication, Jalgaon	National	978-93-90483-66-2	2020-21	https://www.amazon.in/GEOGRAPHY-MAHARASHTRA-PHYSICAL-PAPER-ebook/dp/B0971QFQWH/ref=dp_read_cwrbar_scel_1_2/257-4354664-5545663?pd_rd_w=lumkO&content-id=amzn1.sym.9704eff4-92d0-4a83-8219-5adade825374&pf_rd_p=9704eff4-92d0-4a83-8219-5adade825374&pf_rd_r=W58NGZN3EVBZCSB DYWHJ &pd_rd_wg=5eWqI&pd_rd_r=3f4a460a-e3df-40b2-a702-cb310f4929bf&pd_rd_i=B0971QFQWH&psc=1
-----	-------------	---------------------------------------	-------------------------------	----------	-------------------	---------	---

33.	D. P. Sontakke	Financial System	Prashant Publication Jalgaon		978-93-89493-30-6 (2020)	2020-21	https://prashantpublications.com/books-author/dr-deepak-sontakke/
34.	S. L. Kadam	Mathematical Method in Physics For S.Y.BSc.	Success publication	-	ISBN:978-81-946728-6-9	2020-21	https://www.wonderslate.com/mathematical-methods-in-physics-i/ebook-details?siteName=books&bookId=32683&preview=true&publisher=Success%20Publication
35.	S. L. Kadam	Physics, Electronics for S.Y.BSc.	Success publication	-	ISBN:978-81-946728-5-2	2020-21	https://www.kopykitab.com/Physics-Electronics-Sem-I-by-Dr-Vasant-G-Wagh-Satish-U-Ekar
36.	R. K. Aher	Applied Research In Botany	Mahi Publication, Gujrat. :19-27	-	ISBN-978-93-5067-394-2	2020-21	https://www.rgsm-paranda.org/2020-21/BookPublication2020-21/PPS%20Book.pdf

37.	D. R. Thube	CH-302: Inorganic and Organic Chemistry (CBCS)	Nirali Publications	State	978-93-90225-36-1	2020-21	https://www.wonderslate.com/inorganic-and-organic-chemistry/ebook-details?siteName=books&bookId=25575&preview=true
38.	D. R. Thube	CH-402: Inorganic and Organic Chemistry (CBCS)	Nirali Publications	State	978-93-90506-97-2	2020-21	https://pragatiionline.com/inorganic-and-organic-chemistry-sy-bsc-semester-4-chemistry-ch-402-paper-2/
39.	D. R. Thube	CH-303: Chemistry Practical (CBCS)	Nirali Publications	State	978-93-90437-84-9	2020-21	https://pragatiionline.com/practical-chemistry-ch-303-403-sybsc-sem3-sem4/
40.	T. S. Thopate	CH-302: Inorganic and Organic Chemistry (CBCS)	Prashant Publications	State	978-93-89501-66-7	2020-21	https://www.wonderslate.com/resources/eBook/Dtl?bookId=39266&mode=purchase&buyType=book

41.	T. S. Thopate	CH-402: Inorganic and Organic Chemistry (CBCS)	Prashant Publications	State	978-93-90483-62-4	2020-21	https://www.kopykitab.com/CH-402-Inorganic-And-Organic-Chemistry-SPPU-by-Prof-Dr-K-H-Kapadnis-Dr-T-S-Thopate-Dr-Ramesh-Shirsat-Dr-S-R-Thopate-Dr-D-G-Karpe-Dr-Suresh-Rasale
42.	T. S. Thopate	CH-303: Chemistry Practical (CBCS)	Prashant Publications	State	978-93-89501-67-4	2020-21	https://www.kopykitab.com/Practical-chemistry-III-SPPU-by-Dr-S-B-Takate-Dr-T-S-Thopate-Dr-M-R-Gaware-Dr-S-R-Thopate-Dr-N-R-Dalvi-Dr-D-G-Karpe-Dr-N-T-Dhokale-Dr-S-R-Kuchekar-Dr-Anita-Deshpande

43.	H. S. Shelke	Avkali Vilkhā: Shetkari Vednecha Hunkar	Gawali Prakashan, Islampur	National	978-93- 81831-79-3	2021-22	https://drive.google.com/file/d/1Nf-ju_TZBUAY14LXT0aYTMG6KQtQ4S7O/view?usp=share_link
44.	R. E. Najan	Geography of Disaster Management	Prashant publication Jalgaon	National	978-93- 91391-65-2	2021-22	https://prashantpublications.com/books-category/%e0%a4%ad%e0%a5%82%e0%a4%97%e0%a5%8b%e0%a4%b2-%e0%a4%aa%e0%a4%b0%e0%a5%8d%e0%a4%af%e0%a4%be%e0%a4%b5%e0%a4%b0%e0%a4%a3/
45.	D. S. Ghungarde	Bhartcha Bhugol	Pritam Publication Jalgaon.	National	978-93- 92159-28-2	2021-22	https://www.indiamart.com/proddetail/sprdha-pariksha-bhartacha-bhugol-talikoti-cover-book-27145456873.html

46.	D. S. Ghungarde	Aappati Bhugol	Pritam Publication Jalgaon.	National	978-93-92159-20-6	2021-22	https://m.indiamart.com/prod/detail/sprdha-pariksh-aapatti-bhugol-cover-book-27145132048.html
47.	J. D. Mhaske	Gramin Vikasacha Bhugol	Pritam Publication Jalgaon.	National	978-93-92159-42-8	2021-22	https://www.indiamart.com/proddetail/sprdha-pariksha-gramin-vikasacha-bhugol-cover-book-27152593797.html
48.	S. L. Kadam	Quantum Mechanics T.Y.B.Sc.(Sem.-VI)(PHY-362)	Success Publications	-	-	2021-22	https://www.sharpmultinational.com/course-details/16/2
49.	S.L. Kadam	Mathematical Methods in Physics-II T.Y.B.Sc.(Sem-V)(PHY-351)	Success Publications	-	-	2021-22	https://www.wonderslate.com/Mathematical+Methods+in+Physics+-+II/ebook=details?siteName=books&bookId=35081

50.	R. K. Aher	Biodiversity (Fungal Biofertilizer)	Bharati Publication, New Delhi.120- 136.	-	-	2021-22	https://drive.google.com/file/d/1h0pFCnuIQ7yR-hvHeTKJDt8OVcrUJ8mX/view?usp=share_link
51.	R. N. Deshmukh	Applied Research in Botany Volume-1	Mahi Publication	-	978-93- 90651-59-7	2021-22	https://www.rgsm-paranda.org/2020-21/BookPublication2020-21/PPS%20Book.pdf
52.	R. N. Deshmukh	Plant Physiology and Metabolism	Nirali Publication	-	978-93- 54514-19-7	2021-22	https://www.wonderslate.com/Plant-Physiology-and-Metabolism/ebook-details?siteName=books&bookId=37019&publisher=Nirali%20Prakashan&preview=true
53.	R. N. Deshmukh	Biofertilizers	Prashant Publication	-	978-93- 92425-26-4	2021-22	https://drive.google.com/file/d/1uOy2gfUW-d-DkMJwX8mgLwFVXtfM17SO/view?usp=share_link
54.	S. L. Khapke	Archegoniate	Success Publication, Pune	-	978-93- 24457-49-2	2021-22	https://www.sharpmultinational.com/course-details/16/2

55.	D. R. Thube	CH-504: Inorganic Chemistry (CBCS)	Nirali Publications	State	935451311-5	2021-22	https://pragationline.com/inorganic-chemistry-1-chemistry-ch-504-paper-4-third-year-ty-bsc-semester-5/
56.	D. R. Thube	CH-604: Inorganic Chemistry (CBCS)	Nirali Publications	State	935451409-X	2021-22	https://pragationline.com/inorganic-chemistry-2-chemistry-ch-604-paper-4-third-year-ty-bsc-semester-6/
57.	D. R. Thube	CH-503, 506, 509: Chemistry Practical (CBCS)	Nirali Publications	State	935451474-X	2021-22	https://earning.arihantbooks.com/resources/eBookDtl?bookId=34458&mode=purchase&buyType=book
58.	R. S. Diggikar	CH-603, 606, 609: Chemistry Practical (CBCS)	Nirali Publications	State	935451409-X	2021-22	https://pragationline.com/practical-chemistry-2-chemistry-ch-603-606-609-paper-3-6-9-third-year-ty-bsc-semester-6/

59.	S. M. Kale	CH-510B: Polymer Chemistry (CBCS)	Prashant Publications	State	978-93-89391-98-1	2021-22	https://www.researchgate.net/publication/361735498_polymer
60.	S. M. Kale	Introductory Basics of Chemistry	BFC Publications	National	978-93-5509-98-0	2021-22	https://www.flipkart.com/introductory-basics-chemistry/p/itm24155c422af11
61.	D. R. Thube	CH-603, 606, 609: Chemistry Practical (CBCS)	Nirali Publications	State	935451409-X	2021-22	https://pragationline.com/practical-chemistry-2-chemistry-ch-603-606-609-paper-3-6-9-third-year-ty-bsc-semester-6/

B. List of Articles in Proceedings

Sr. No.	Name of Teacher	Title of the Books and Chapter / Title of Paper in Proceeding	Name of conference and Title of Proceedings	Name of Publisher	National / International	ISBN/ ISSN number of Proceedings	Year	Web Link
1.	V. S. Bhalsing	Prachin Va Madhyayugin Newase	Adhunik Maharashtra Wanchitanche Itihaslekhana	Principal, New Arts, Com & Sci College, Parner	National	978-81930154-3-5	2017-18	https://drive.google.com/file/d/1OFgPNSDTr6pZWJWcYdUCrYi8KyidGp/view?usp=sharelink

2.	B. J. Kakade	Kamgar Chalval Ani Narayan Meghaji Lokhande	Adhunik Maharash tratil Vanchitan che itih as lekhan	Principal R.K.Aher New Arts Commerce & Science College Parner	National	978- 81930154 -3-5	2017 -18	https://drive.google.com/file/d/10VGqDXgxAj7idStwx4JFsincCPoRh0Wm/view?usp=share_link
3.	A.T. Gandal	Prachin Newase	Adhunik Maharash tratil Vanchitan che itih as lekhan	Principal R.K.Aher New Arts Commerce & Science College Parner	National	978- 81930154 -3-5	2017 -18	https://drive.google.com/file/d/10FgPNSDTr6pZWJWcYdUCrhyi8Kyi_dGp/view?usp=share_link
4.	R. A. Shinde	Applications of Graph Theory in Science And Technology	National Conferenc e on "Graph Theory And Its Applicati ons"	New Arts Commerce And Science College, Parner	National	ISBN: 978-81- 930155-0- 9	2017 -18	https://drive.google.com/file/d/1CNyERBOYw9dw7Xx-mcuW-AE2lLn3VWlm/view?usp=share_link
5.	S. S. Thube	Challenges Faced in Marketing Branded Products in Rural and Urban Market	Internatio nal Conferenc e on 'Challeng es in Multitudi nal Managem ent Orbits'.	IMS, Ahmednagar	Internationa l	ISSN No: 0976- 1845	2017 -18	https://drive.google.com/file/d/1KrahEJ1zJmsfwVHC--3eEBR87Uq8bsth/view?usp=share_link

6.	M. P. Gawali	Strategies for developing Indian Dairy in Changed Global Scenario	National Level Seminar on “Emerging trends, Issues, Opportunities and Challenges in Agriculture Marketing”	Amrutvahini institute of management and business administration, sangamner	National	ISBN : 978-93-87665	2017-18	https://www.researchgate.net/profile/Vijaykumar_S/publication/323547627_Systematic_Analysis_of_E-Agricultural_Alert_System_for_the_Farmers/links/5a9c334945851586a2ae285f/Systematic-Analysis-of-E-Agricultural-Alert-System-for-the-Farmers.pdf
7.	B. G. Ghule, V.B. Sherkar, M.S. Parjane & R.G. Korde	Application of Graph theory in the digital electronics	Graph Theory and its applications	NACS College, Parner	National	ISBN 978-81-930155-0-9	2017-18	https://drive.google.com/file/d/15drM6ltppkBEAzB2NSp8AQ721SI9hFE2/view?usp=share_link

8.	S. L. Kadam	Nanotechnology for energy applications	International conference on Nanotechnology for human welfare	H.V. Desai College, Pune	International	ISBN 978-93-87317-98-7	2017-18	https://drive.google.com/file/d/1JCJCILyw4stSF91KnGx0nBLvKt7pXG_q/view?usp=share_link
9.	S. L. Kadam	Solar energy and environment	International conference on Recent Trends in Life Sciences	NACS College, Parner	International	-	2017-18	https://drive.google.com/file/d/1oVTwoSgsX3zDTkrk9JfGFwZltCi5W5wS/view?usp=share_link
10.	R. D. Sonawane	Interdisciplinary Application of Mathematics	Graph Theory and it's Applications	NACSC Parner	National	978-81-930155-0-9	2017-18	https://drive.google.com/file/d/1p5djXdm0oyUNF_fbEc3yzMA7vbGr2IFr/view?usp=share_link
11.	V. M. Gadge	Applications of Graph Theory in Science & Technology	Graph Theory and it's Applications	NACSC Parner	National	978-81-930155-0-9	2017-18	https://drive.google.com/file/d/1PB3N7IqBNbh96I4FTVIAsqf7E-lx5zAw/view?usp=share_link

12.	S. R. Shinde	The Domination in Graph Theory	Graph Theory and it's Applications	NACSC Parner	National	978-81-930155-0-9	2017-18	https://drive.google.com/file/d/1IKAh4La5SOhi8t639H36kffyyCFeCo3/view?usp=share_link
13.	C. V. Medhekar	Survey of Graph Energy's	Graph Theory and it's Applications	NACSC Parner	National	978-81-930155-0-9	2017-18	https://drive.google.com/file/d/1PdWdc-CRZD4UGBqoUYMbg1DjjpWnVo/view?usp=share_link
14.	A.M. Taware	Application of Graph Theory in Electrical Circuit.	Graph Theory and it's Applications	NACSC Parner	National	978-81-930155-0-9	2017-18	https://drive.google.com/file/d/12ygrVLUkWkVFBE7ulMD8Jf1MkUICDn4/view?usp=share_link
15.	A.S. Tarade	Application of Graph theory in combinatorics	Graph Theory and it's Applications	NACSC Parner	National	978-81-930155-0-9	2017-18	https://drive.google.com/file/d/1XSgZU-QCdOnUpmhe7NPxKBwoXsvqRZXA/view?usp=share_link

16.	D. D. Pathave	Applications of Spectral Theory	Graph Theory and it's Applications	NACSC Parner	National	978-81-930155-0-9	2017-18	https://drive.google.com/file/d/1VZw8zk_XpIM_V_F9bgEgFLZ0iOFFNYfh4/view?usp=share_link
17.	S. B. Shinde	Application of Graph Theory in Computer Science	Graph Theory and it's Applications	NACSC Parner	National	978-81-930155-0-9	2017-18	https://drive.google.com/file/d/1VZw8zk_XpIM_V_F9bgEgFLZ0iOFFNYfh4/view?usp=share_link
18.	U. S. Chaudhari	Applications of Graphs in Real Line	Graph Theory and it's Applications	NACSC Parner	National	978-81-930155-0-9	2017-18	https://drive.google.com/file/d/1SuggYs-ULe9NG2WnKlpBsF8Ejnt6t1jA/view?usp=share_link
19.	N. T. Mandge	Application Of Graph Theory In Daily Human Life	Graph Theory And it's Application	NACSC Parner	National	978-81-930155-0-9	2017-18	https://drive.google.com/file/d/1t6CE18-M4UEki_eOedMdmRhBWYiH25A/view?usp=share_link

20.	S. A. Shinde	Applications of Graph Theory in Science and technology	Graph Theory and Its Applications	NACSC, Parner	National	978-81-930155-0-9	2017-18	https://drive.google.com/file/d/16fgjVUP6ltZ5fVoiplYToCcYV5iGlF6u/view?usp=share_link
21.	H. S. Shelke	Dr. Babasaheb Ambedkar Yanche Shikshan Vishayak Vichar	Jagtik Starawar Shahu Maharaj Mahatma Phule & Dr. Babasaheb Ambedkar yanche yogdan	Sneha wardhan Prakashan, Pune	International	978-93-87628-42-7	2018-19	https://drive.google.com/file/d/1vfBmRDuNnQONPGg_pXeLm2EDlxT WXgwd/view?usp=share_link
22.	D. P. Sontakke	Qualitative Research Methodology in social sciences	National conference on Research Methodology in social sciences	Prashant Publications Jalgaon Feb 2019	National	ISBN 978-93-88769-34-1	2018-19	https://drive.google.com/file/d/1J9eraqDymEUFv nwYCWAL6609QmH VINWv/view?usp=share_link
23.	V. P. Dhawle	Phase changes under heat treatment during synthesis of Alpha-Al ₂ O ₃ by Sol Gel method	International conference on material and environment	Shri Yashwantrao Patil Science College, Solankur, Kolhapur	International	ISSN 2279-0543	2018-19	https://drive.google.com/file/d/1TkWHK25euBZjz5exeLfkFywHbLBL41hD/view?usp=share_link

24.	V. P. Dhawle	Phototoxicity of nanoparticles on plant growth	Emerging materials and nanotechnology(EMAN-2019)	C. T. Bora College, Shirur	National	----	2018-19	https://drive.google.com/file/d/1CUkIOYKIZBpmTtWaNpbj0WZaDrO2hrC/view?usp=share_link
25.	S. L. Kadam	Synthesis and Characterization of Bismuth Ferrite by Sol gel method	Sustainable materials for advanced research in technology	B.G. College Sangavi Pune	International	----	2018-19	https://drive.google.com/file/d/12_1MYquA-QzYneli4tZ62xXul0ifmAel/view?usp=share_link
26.	S. L. Kadam	Synthesis and Characterization of silica nanoparticles via stober's method	Innovation in physical chemical and life sciences	NACS College, Parner	International	ISBN 978-81-926129-6-6	2018-19	https://drive.google.com/file/d/1pugFYAX5QknH50PN841kydrp1GIP5aTG/view?usp=share_link
27.	S. L. Kadam	Effect Of Sintering On Zn- Mn Ferrite	Innovation in physical chemical and life sciences	NACS College, Parner	International	ISBN 978-81-926129-6-6	2018-19	https://drive.google.com/file/d/1AodzcvjAgRqljgkzaLBIfbDj6c4LjTDP/view?usp=share_link

28.	P. N. Patil	A Comparison Of Classification Methods: Naïve Bayes And Support Vector Machine	IJCI Conference	International Journal of Management and Economic	International	ISSN 2231-4687	2018-19	https://drive.google.com/file/d/1prt9SFdH2_fMLi0IcK5v30dVeA5NjZWh/view?usp=share_link
29.	H. S. Shelke	Ramabai Ambedkar Yanche Dr. Baba Sahebanchya Kutumbatil Yogdan	Desh Ani Videshatil Vividha Khetratil Stree Kartrutwache Yogdan	Sneha Wardhan Prakashan, pune	National	978-93-87628-75-5	2019-20	https://www.bookey.com/Preview/BookPreview.aspx?BookId=4747614601550762861&PreviewType=books
30.	A.T. Gandal	Prachin Va Madhyayugin Newase	History of Subaltern Movement in Modern Maharashtra	Dr.M.K.Fasale Prin. Late Abasaheb Kakade Arts Coollege Bodhegaon	State	978-93-5406-179-0	2019-20	https://drive.google.com/file/d/11CBdTGpE8CHgedN11KEh19NxPJH0_vQM/view?usp=share_link
31.	V. S. Dhanashetti	Pros & Cons of Indian Nationalism: Is India a Nation	2 days National seminar on Contemporary issues in political science	Navjyot Publication	National	2277-8063	2019-20	https://drive.google.com/file/d/1ymvYFM2_j87jDfE_tIptPptmct9G7Aky/view?usp=share_link

32.	S. A. Thombare	Contribution of Achievements of Women In Various Field at National & International Levels :- Women are the Real Architect of Society	22th International Interdisciplinary conference, Pune Contribution of Achievements of Women In Various Field at National & International Levels	Snehavardhan Prakashan & Rayat Shikshan Sanstha's Dr. Babasaheb Ambedkar College, Aundh, Pune	International	978-93-87628-758-5	2019-20	https://drive.google.com/file/d/11grxDuT00JknKjw4sbLNcjU5A5BvjfW/view?usp=share_link
33.	Y. M. Waghere	Challenges before Service Sector in India	Challenges before Indian Economy	Dr. Yuvraj Waghere	National	--	2019-20	https://drive.google.com/file/d/1umzXvdFbzIK0S-r3bP3K3c2U5DIY6Lp/view?usp=share_link
34.	S. S. Pathare	Agriculture Sector in India	Challenges before Indian Economy	Mr. Shivaji Pathare	National	--	2019-20	https://drive.google.com/file/d/1I Giayo9E_LXVD99Uc8zSodtGcasw9H8W/view?usp=share_link

35.	B. D. Bhalerao	Challenges before the skill development in India	Challenges before Indian Economy	Dr. Bhushan Bhalerao	National	--	2019-20	https://drive.google.com/file/d/1b6iNCuETKj6sIIoJJUMJfiT7P-Z6Y_jN/view?usp=share_link
36.	T. Galbote	Impact of GST on Indian Economy	Challenges before Indian Economy	Mr. Tushar Galbote	National	--	2019-20	https://drive.google.com/file/d/1KcTf-Ee6MPyx2-hKpYApPEknyJy5B7/view?usp=share_link
37.	K. Tele	Important Challenges and Prosperous of Indian Economy reference to Agriculture Sector	Challenges before Indian Economy	Dr. Kakasaheb Tele	National	--	2019-20	https://drive.google.com/file/d/1gnQ-ydrQXizuwOOx68HGpo4iVdc3Awq/view?usp=share_link
38.	R. A. Shinde	Introduction To Indian Economy And Problems Faced By It	National Seminar On "Challenges Before Indian Economy"	New Arts, Commerce and Science College, Parner	National	-	2019-20	https://drive.google.com/file/d/18nNVwcMzeGGexvIAF07GyrMECMAfY4p/view?usp=share_link

39.	S. S. Thube	Challenges Before Agricultural Sector In India	National Seminar On “Challenges Before Indian Economy ”	New Arts Commerce And Science College, Parner	National	-	2019-20	https://drive.google.com/file/d/1w8ivJbb0bU_ftDT0ceJOwvRPXzPrsL3d/view?usp=share_link
40.	S. L. Kadam, V.P. Deore, V.B. Sherkar, G.M. Repale	Structural and magnetic characterization of multiferronic Bismuth Ferrite nanoparticles by sol gel method	Advanced functional materials synthesis characterization & applications	Arts Commerce And Science College Baramati	National	-	2019-20	https://drive.google.com/file/d/1ZM997t-9LKcVsKV8AQ22IHRD6MYwxQLd/view?usp=share_link
41.	S.L. Kadam	Electrochemical synthesis of CuS thin film for supercapacitor application	Advances in Materials Science	Raje Ramrao Mahavidyalya Jath	International	-	2019-20	https://drive.google.com/file/d/1UstuFxpdoNVm7x9CuraycNfbjRHkcBg/view?usp=share_link
42.	S. L. Kadam, S. D. Aher, R. B. Kharade	Synthesis Characterization and Application of ZnO by Mechanochemical method	Raman Memorial Conference Novel Materials for a Sustainable Future	Dept Of Physics S.S.P.U Pune	State	-	2019-20	https://drive.google.com/file/d/1s156kWVhcorrzDHvFrAviiVVwefZG6g1/view?usp=share_link

43.	B. S. Narsale	Internet of Things with Blockchain	Internet of Things & its Applications	Principal, NACS College, Nagar	International	2348-1269	2019-20	https://drive.google.com/file/d/1qMBHQmnDNFOaQ00jJPngFX-OL_ytVsKE/view?usp=share_link
44.	S. L. Kadam	ME output in magnetoelectric composites	Recent Advances in Material Science and Nanotechnology	Department of Physics, Yashvantrao Chavan College of Arts Commerce and Science College, Sillode	National	-	2020-21	https://drive.google.com/file/d/1bUE2_KJd_F9kii-RiawUVVtz4Lg6PpLC/view?usp=share_link
45.	V. P. Dhawale	Optimization of crystal violet Dye for decolorization using Aluminum oxide nanoparticles	Recent trends in 2D nanomaterials synthesis, properties & applications : A virtual event	Nano science Nanotechnology, Amity University	International	-	2020-21	https://drive.google.com/file/d/18r61HI-iBiav43WcB4-iUR5gOjI37MTQ/view?usp=share_link
46.	R. D. Sonawane	Connecting Past With Present Mathematics Education.	Mathematics Education	National Council of Educational Research & Training Regional Institute of Education Bhopal.	National	-	2020-21	https://drive.google.com/file/d/1Jq2B3sKkiQCynvasgpuUqIpTrsf0nDlo/view?usp=share_link

47.	R. D. Sonawane	Special Function and Its Multidisciplinary Application	Special Functions & Application	Department Of Mathematics & Computer Science, Babu Banarasi Das University, Lucknow, India	International	-	2020-21	https://drive.google.com/file/d/1r2_Rrhqu3t4Uqx_-ab6b1IGvxEyJbUrC/view?usp=share_link
48.	R. D. Sonawane	Importance Of Technology in Mathematics Teaching.	Indian Science Techno Festival (I FST-2021) (Virtual)	1. Raman Science Technology Foundation 2. National Council Of Teacher Scientist, India 3. APJ Abdul Kalam National Council Of Young Scientist	National		2020-21	https://drive.google.com/file/d/1AJ_a6ci0uPaaZAsMsWAGVd_oYCbDkj/view?usp=share_link
49.	B. B. Shelke	Strategy of e-marketing Library information	Research Methodology in Library Science	Anandibai Rorane Arts College, Vishrantwadi	International	--	2021-22	https://drive.google.com/file/d/1a1drz9tbMgB4OInWICtfVmQrNjH4e0gZ/view?usp=share_link

50.	S. L. Kadam, R.B. Kharade	Ferrite and Ferroelectric Properties of (y) BaTiO ₃ + (1-y) Ni _{0.90} Co 0.05Cu 0.05 Fe ₂ O ₄ Composites	One Day National Conferenc e On “Advance d Materials, Technolo gy, Applicati ons And Education ” “Advance d Materials, Technolo gy, Applicati ons And Education ” [AMTAE -2021]	Hon. Balasaheb Jadhav Arts, Commerce & Science College Ale, Tal. Junnar, Dist. Pune- 412411.	National	---	2021- 22	https://drive.google.com/file/d/16cmKdXYmZoNeDvWD7-oBhIBrZrh0Uo-/view?usp=share_link
51.	S. L. Kadam, R.B. Kharade	Characterizatio n of Manganese Substituted Zinc Ferrites (OP 45)	Internatio nal Symposiu m on “New Trends in Science and Technolo gy” (NTST- 2021)	NACS College, Parner	Internation al Symposium	---	2021- 22	https://drive.google.com/file/d/1bmHdEonRLV-OmHj5fAjtYbS5gwbU9CBJ/view?usp=share_link
52.	V. P. Dhawale	Optimization And Decolorization Of Methylene Blue Dye Using Aluminium Oxide Nanoparticles (OP 88)	AMTAE- 2021	Ale College, Ale	National	----	2021- 22	https://drive.google.com/file/d/1EVDw4P0c0-yPhmizQCY-IeJy8lagQVew/view?usp=share_link

53.	V. P. Dhawale	Graphene: The Wonder Nanomaterial (OP 89)	AMTAE-2021	Ale College, Ale	National	---	2021-22	https://drive.google.com/file/d/1oVeAMWtQ12mxw6nsXuMGy4vuvztGFV/view?usp=share_link
54.	V. P. Dhawale	Effects of spent wash on the physico-chemical properties of soil and early seedling growth in fenugreek (Trigonella foenum graecum)	(NTST-2021)	NACS College, Parner	International Symposium	---	2021-22	https://drive.google.com/file/d/1DYiNNLOCzg12N_iY2mvuezWmmN3j_0J/view?usp=share_link
55.	R. B. Kharade	Mechano-Chemical Method for Synthesis of Zinc Oxide Nanoparticles	AMTAE-2021	Ale College, Ale	National	---	2021-22	https://drive.google.com/file/d/1ZMmMnxFCYrk0ImqLQ5USZ7bVzYjViLJJ/view?usp=share_link
56.	N. A. Pawar	Low-Density Teos-based Silica Aerogels Prepared at Supercritical Drying Using Ethanol as the Preparative Solvent	(NTST-2021)	NACS College, Parner	International Symposium	---	2021-22	https://drive.google.com/file/d/1NOrrifQ1G_QYOCfLuPLyWtbQPmUADo6/view?usp=share_link

57.	N. A. Pawar	Effect Of The Pr (Praseodymium) Substitution On The Structural, Magnetic And Adsorption Properties In Cobalt Ferrite Nanoparticles (OP118)	AMTAE-2021	Ale College, Ale	National	-	2021-22	https://drive.google.com/file/d/1NeN8yACjk5LpyxuJFdy6auKiT2MgfH7a/view?usp=share_link
58.	R. M. Shaikh	Antifungal activity of <i>vitex nigundo</i> linn. Against some pathogen of <i>allium cepa</i>	Advanced Material, Technology, application and Education	-	National	-	2021-22	https://drive.google.com/file/d/1EbY3mPn40a8ItpXDUKHMBmupERqB4Dm-/view?usp=share_link
59.	R. D. Sonawane	The Impact Of 19 Pandemic On Mathematics Higher Education	Recent Studies In Applied Sciences (RSAS-2022)	NACSC Parner	National	-	2021-22	https://drive.google.com/file/d/1gip7xkyx6XQqhdnPIWruzeahKLD-__C/view?usp=share_link
60.	R. D. Sonawane	Interdiciplinary Approach Of Garph Theory	New Trends in Science & Technology	NACSC Parner	International	0975-1386	2021-22	https://drive.google.com/file/d/10HTrUIvyuzi1BHrlXSGOgHiY5KyQIZMg/view?usp=share_link

61.	K. A. Pawar	Application Of Number Theory In Computing/ Cryptography	Recent Studies In Applied Sciences. (RSAS-2022)	NACSC Parner	National	-	2021-22	https://drive.google.com/file/d/1Iisa Ct O1lwSbgqYcn5jnvGJin6oJAa/view?usp=share_link
62.	N. T. Mandge	Application Of Operational Research To The Transportation Problem	Recent Studies In Applied Sciences.(RSAS-2022)	NACSC Parner	National	-	2021-22	https://drive.google.com/file/d/12eLvpX3DvHBDLR-yE1Kp mxlRqix muuJR/view?usp=share_link
63.	V. C. Gadhawe	Application Of Computaional Geometry	Recent Studies In Applied Sciences.(RSAS-2022)	NACSC Parner	National	-	2021-22	https://drive.google.com/file/d/1sGh6NpOy_yAyDFgBxWpOg2cUvo9MUFca/view?usp=share_link
64.	D. S. Kaware	Uses Of Graph Coloring In Day To Life.	Recent Studies In Applied Sciences.(RSAS-2022)	NACSC Parner	National	-	2021-22	https://drive.google.com/file/d/11PEMkj3wYmGAw5-5QPQ66BXNqKnN-nsa/view?usp=share_link

65.	S. S. Raskar	Application Of Number Theory In Statistics	Recent Studies In Applied Sciences.(RSAS-2022)	NACSC Parner	National	-	2021-22	https://drive.google.com/file/d/1gMoKCCqBGtwmVZJkbfp_cywJydvGgklz/view?usp=share_link
66.	S. P. Gaikwad	Secure Home doorbell using python and raspberry PI	Recent Studies in Applied Science	NACSC, Parner	National	ISBN 978-81-926129-5-9	2021-22	https://drive.google.com/file/d/1oVkma9CgZBpu2KN2RDP6PcqYpZZadnv/view?usp=share_link
67.	A. P. Wabale	Role of Artificial Intelligence in Human Computer Interaction	Recent Studies in Applied Science	NACSC, Parner	National	ISBN 978-81-926129-5-9	2021-22	https://drive.google.com/file/d/1EIQZHXWpRXBzTaFuHMsqm8LbOVSUCoS/view?usp=share_link
68.	N. B. Sobale	Multitank Drone Spray using AI	Recent Studies in Applied Science	NACSC, Parner	National	ISBN 978-81-926129-5-9	2021-22	https://drive.google.com/file/d/1QigoCzr42c_QUDIEq-9gCLvI8DP3R7WL/view?usp=share_link

69.	P. B. Patade.	Online or Offline: Artificial Intelligence	Recent Studies in Applied Science	NACSC, Parner	National	ISBN 978-81- 926129 -5-9	2021- 22	https://drive.google.com/file/d/1l-d9tn1BhN8cjNeGc6kFxNU0iVriKYnx/view?usp=share_link
-----	---------------	---	--	------------------	----------	-----------------------------------	-------------	---

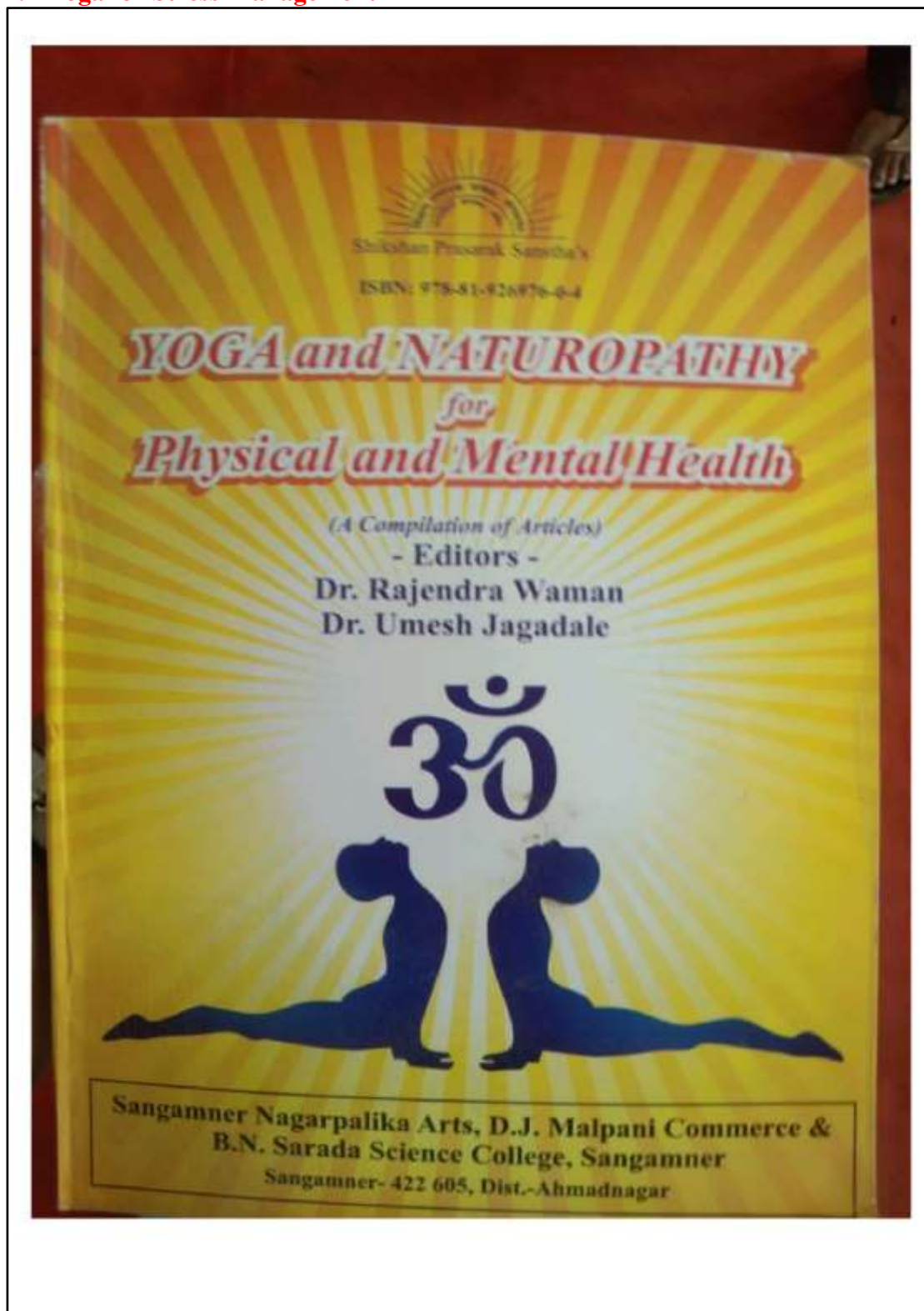
Books, Chapters Published**1. Yoga for Stress Management**

Yoga and Naturopathy for physical and Mental Health

YOGA FOR STRESS MANAGEMENT

(A Compilation)

Sanjay Gaikwad
Director of Physical Education & Sports (M.S.)

Man has made tremendous progress in science and technology. As a result of this, luxurious service is available in the market as well as at your doorstep. Due to this luxurious life style and physical inactivity, society is facing new social problem known as HYPOKINETIC disease. This disease results in the increased level of stress, anxiety, depression, hypertension, osteoporosis, back pain, etc. To overcome this social problem one of the remedies is to do daily physical exercise and perform yogic programme regularly.

Meaning – Stress is usually talked about in negative terms. Stress is the body's physical, mental, and behavioural changes to circumstances.

Definition – 'Stress is any influence which disturbs the natural equilibrium of the body' – Wintage

'Stress is the nonspecific response of the body to any demand'. – Hans Selye

Stresser – Any physical or psychological event or condition that produces stress.

Types of stress –

1. Eustress
2. Distress

Stages of stress –

1. The Alarm Reaction
2. Resistance Stage
3. Exhaustion

Causes of stress –

There is a proverb that "the birds' stress and worry fly above your head." Human beings should learn from this. There are following causes of stress :

1. Internal
2. External
3. Personal factor
4. Occupational factor

S. N. Arts, D.J.M. Com. & B.N.S. Sci. College, Sangamner

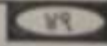

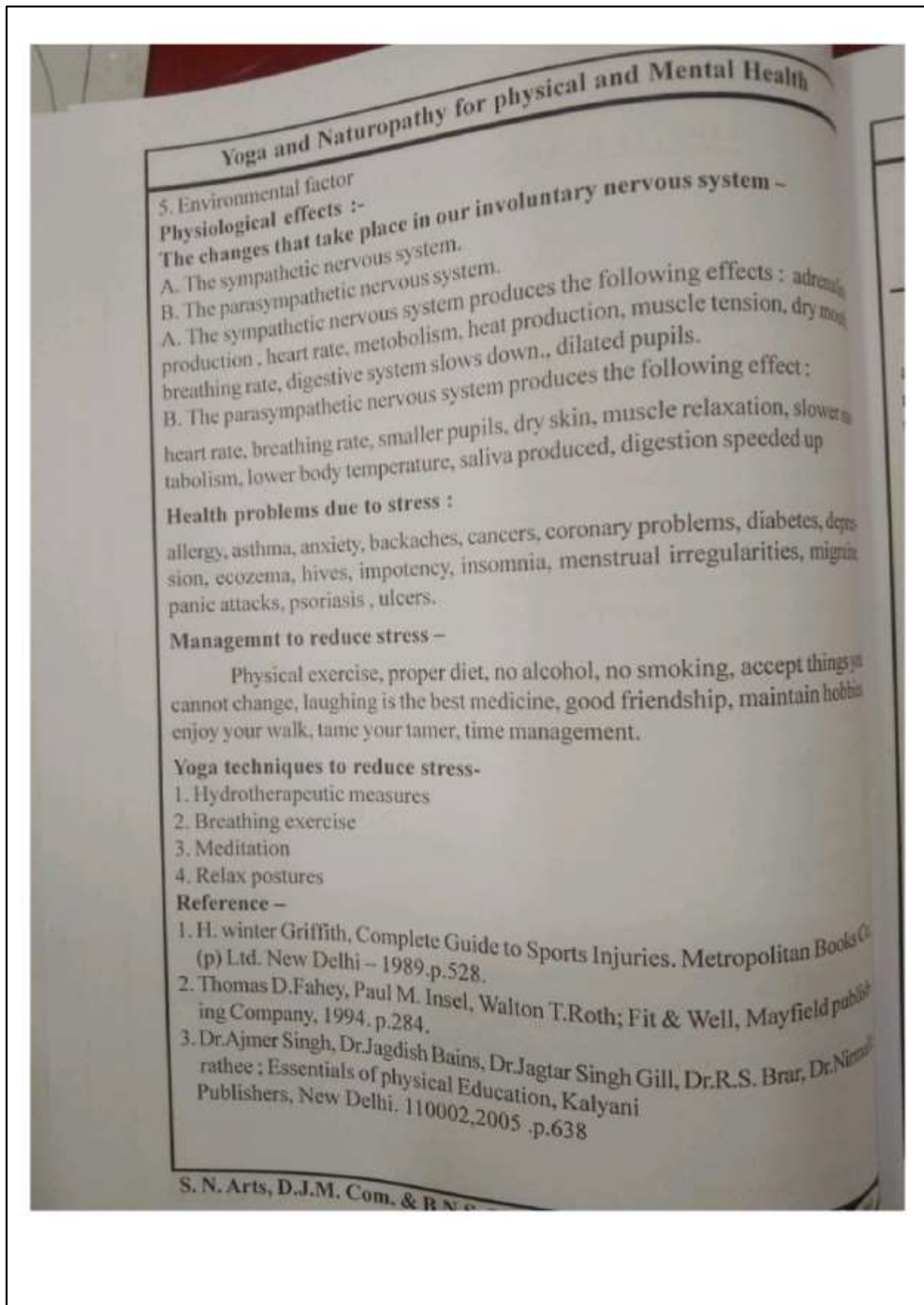

2. Fundamentals of Botany

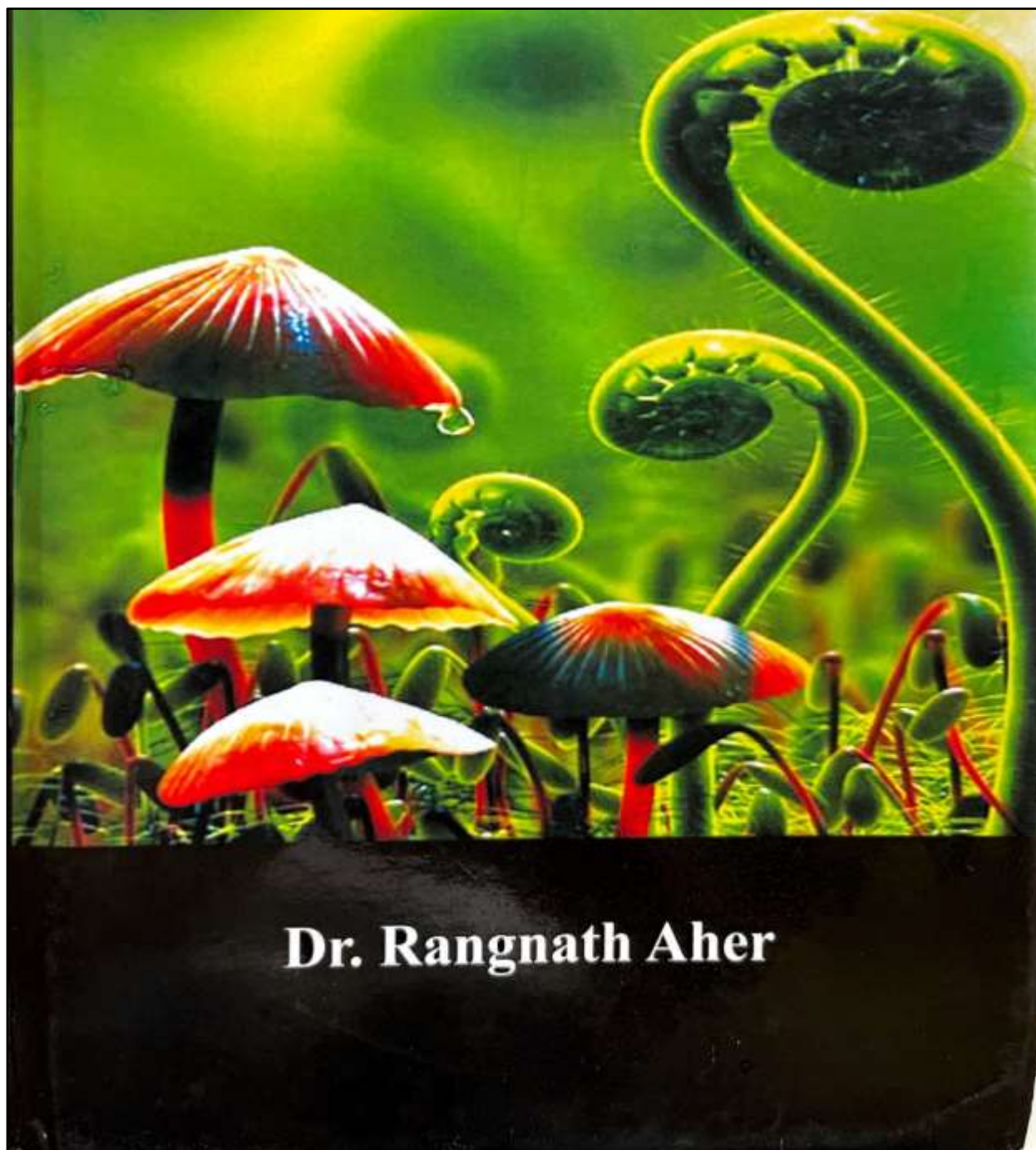

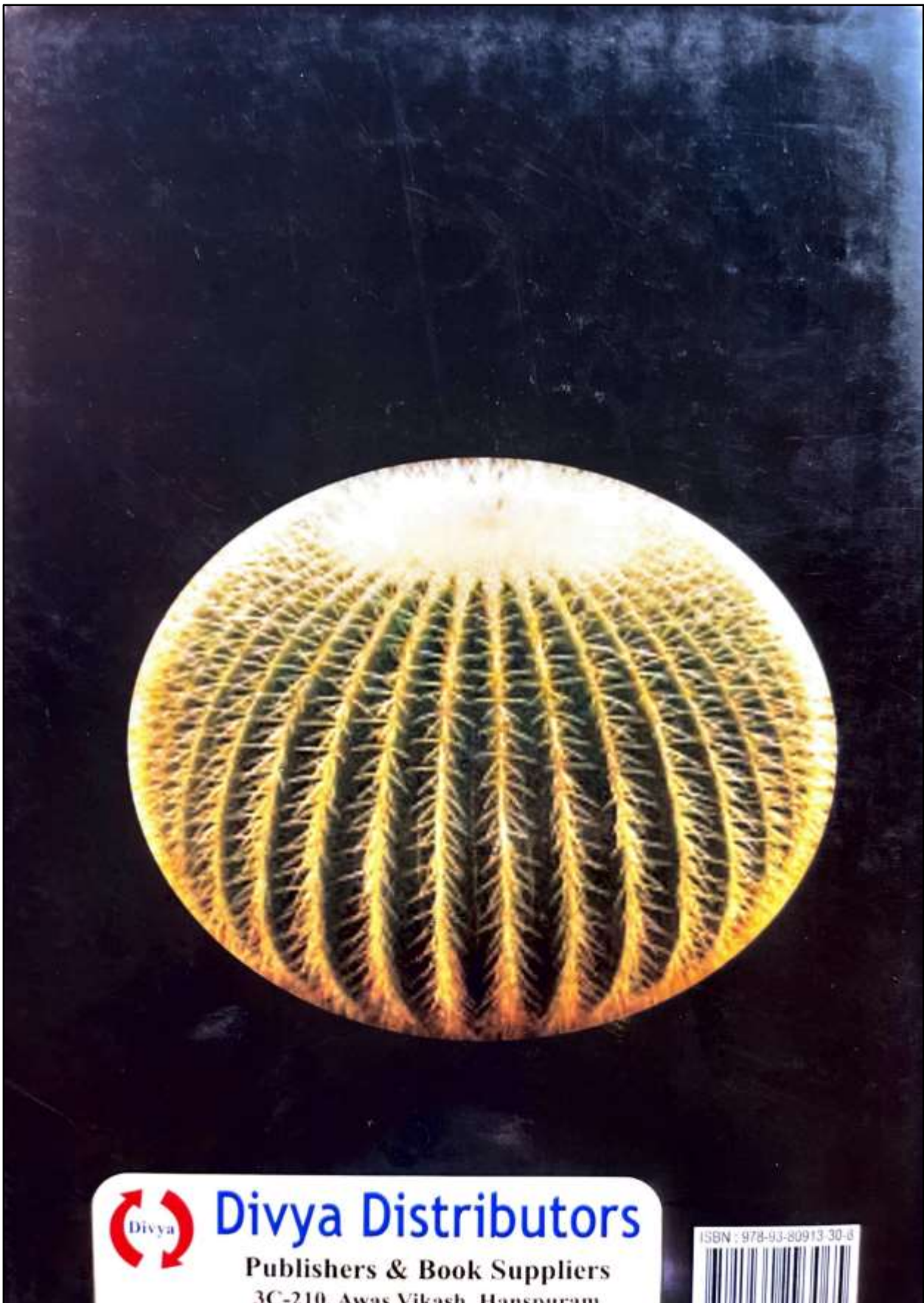

ISBN : 978-93-80913-30-8

Book : **Fundamentals of Botany**
Editor : **Dr. Rangnath Aher**
© **Author**
Edition : **2017**
Price : **Rs. 895.00**
Publisher : **Divya Distributors**
Awasthi Vikas Hanspuram
Kanpur - 208021
Mo. : 9451424548
E-mail ID : **divyadistributor's1@gmail.com**
Composed by : **Vishnu Graphics, Kanpur**

FUNDAMENTAL OF BOTANY

Edited by : Dr. Rangnath Aher

Price : Rs. Eight Hundred Ninety Five Only

3. Sorghum: Water Stress

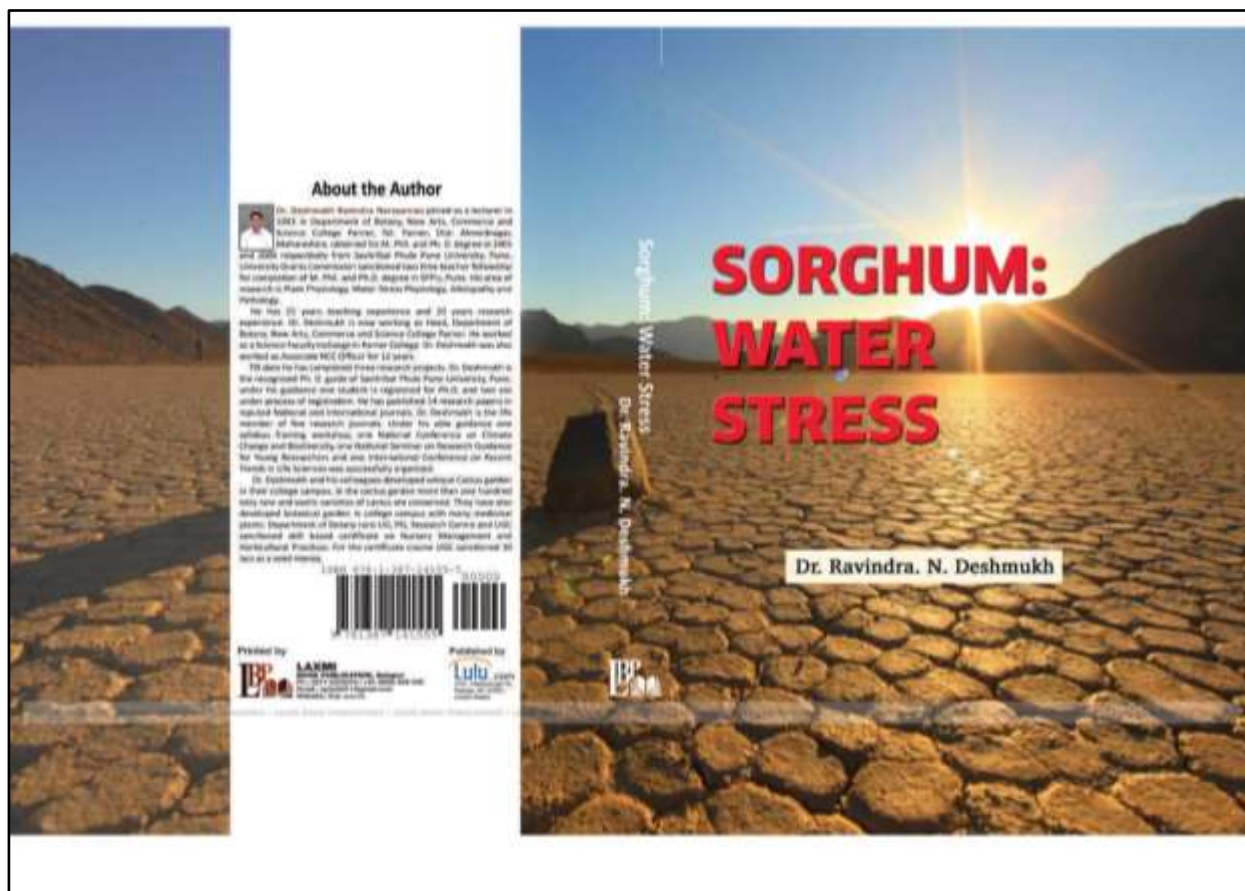

4. Introduction to Environmental Biology

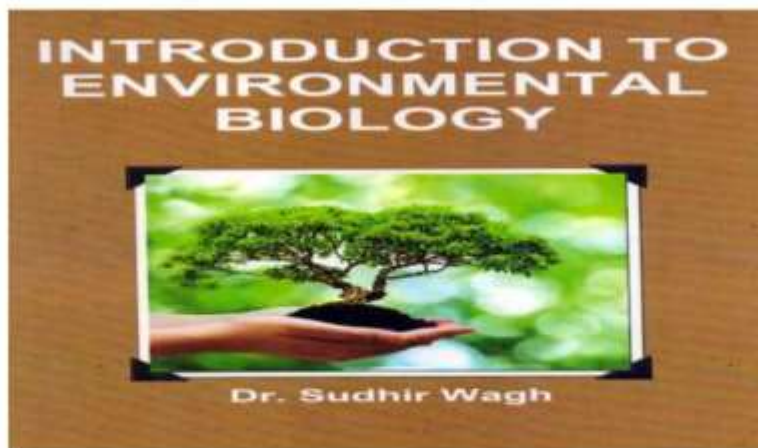

INTRODUCTION TO ENVIRONMENTAL BIOLOGY

BY
Dr. Sudhir Wagh

Published by
Lulu Publications, North Carolina, USA



5. A Study of Indian Ethos: in The Glass Palace of Amithav Ghose

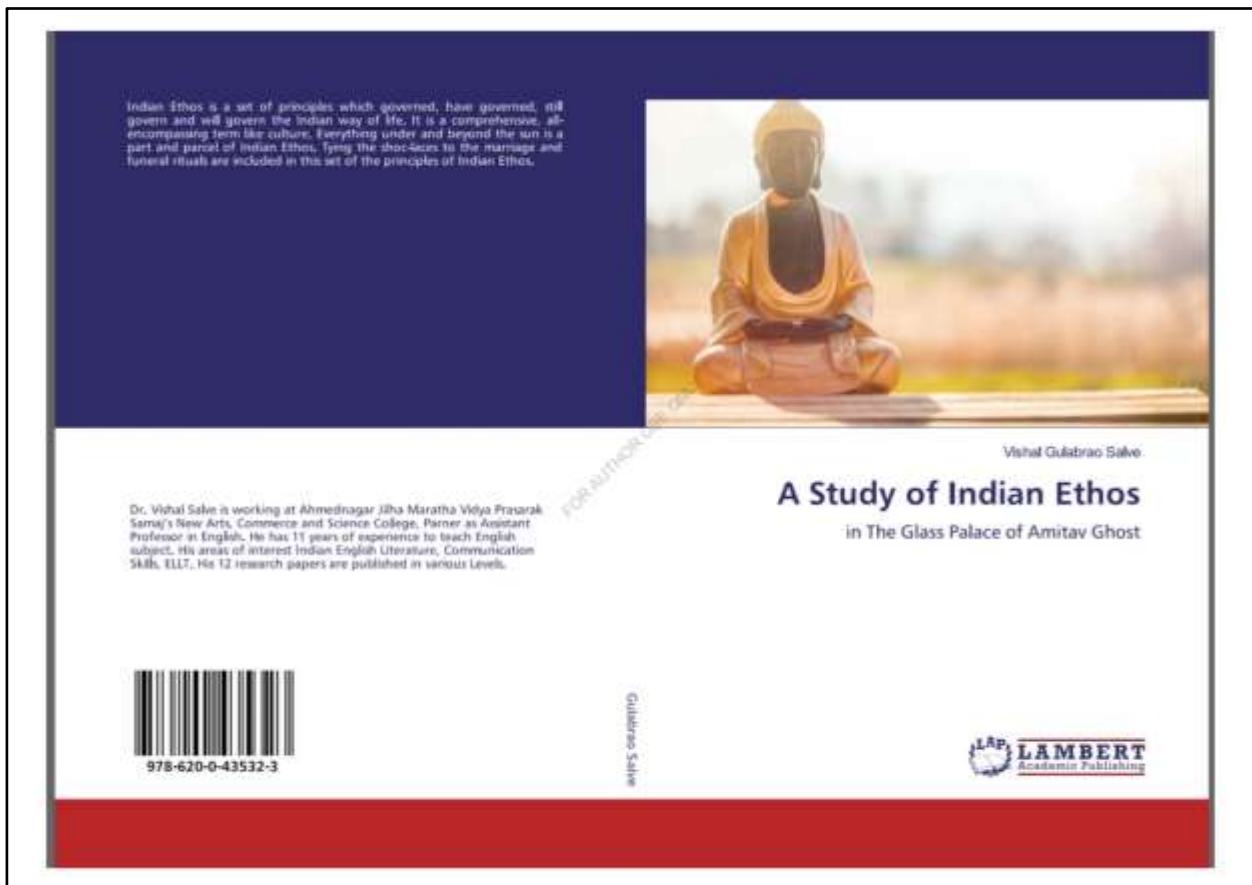

6. A Study of Indian Ethos: in The Hungry Tide of Amithav Ghose

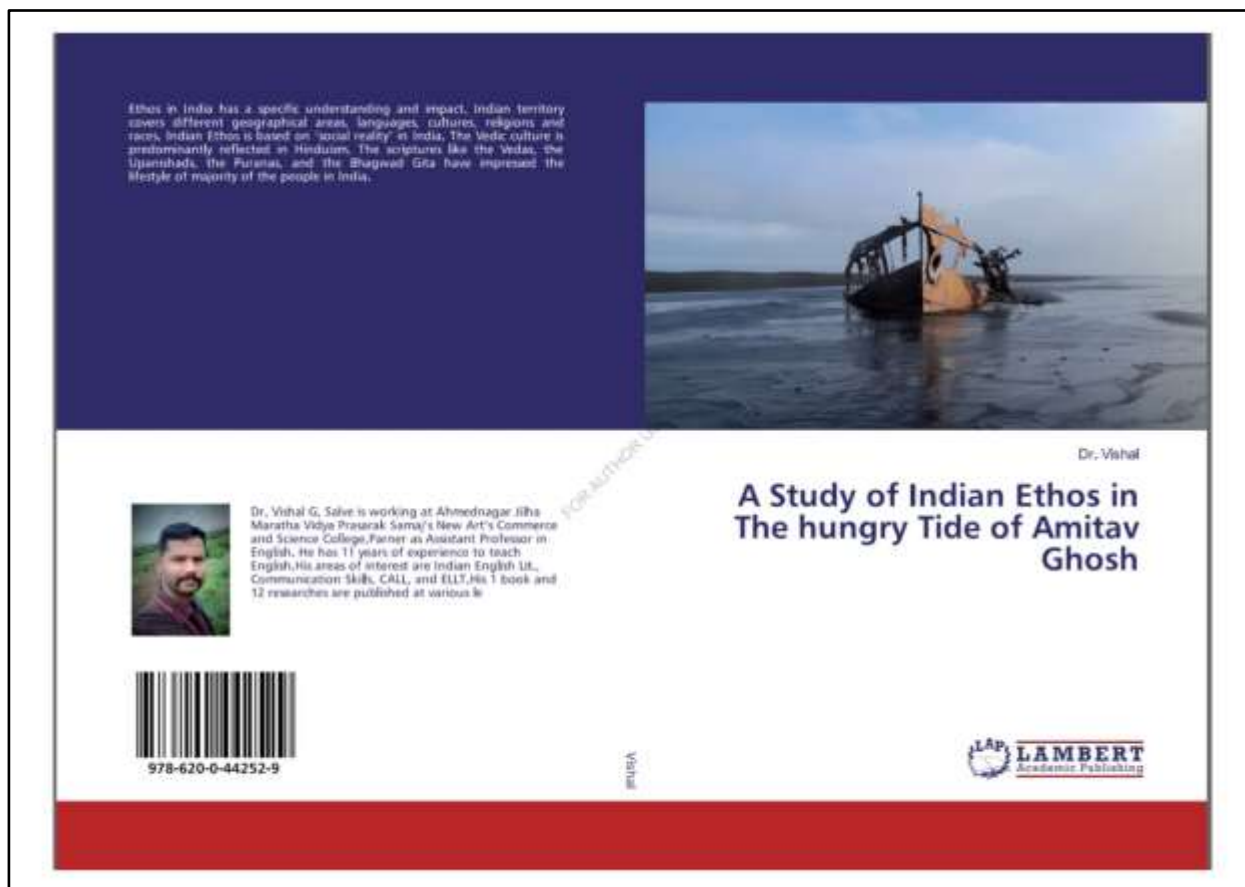

7. Amitav Ghosh: A Study of Indian Ethos in Sea of Poppies

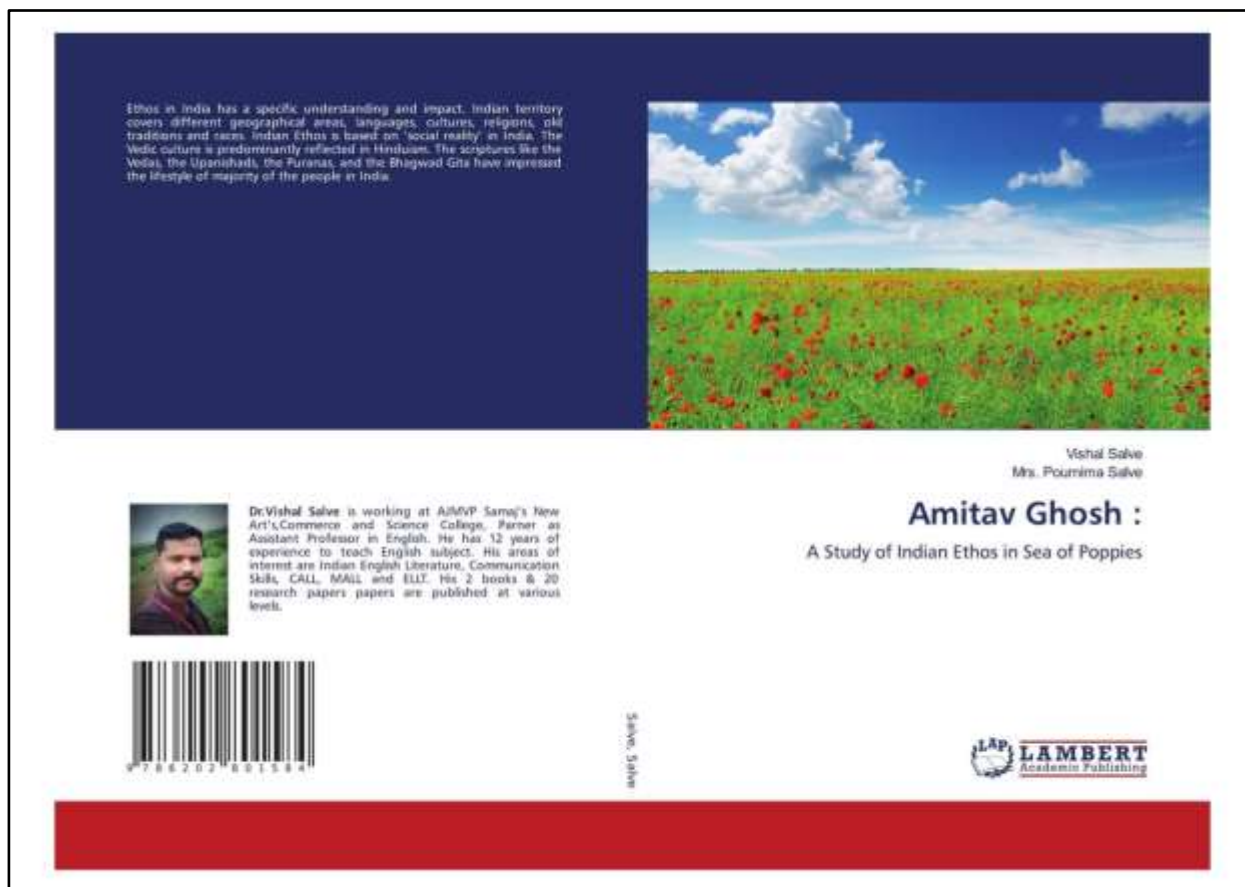

8. Amitav Ghosh: Eine Studie über das indische Ethos im Mohnblumenmeer (German Edition)

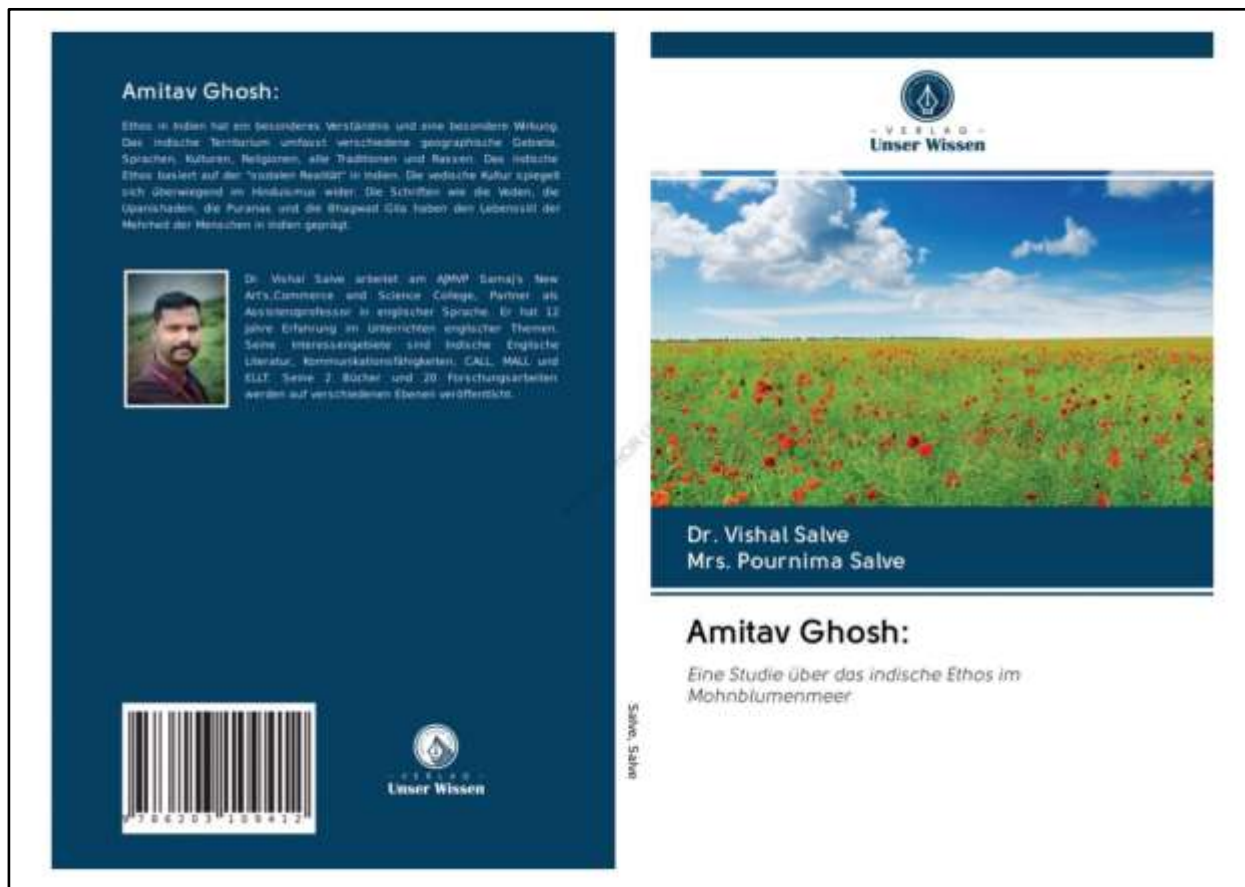

9. Amitav Ghosh: Une étude de l'ethos indien dans la mer de pavots (French Edition)

Amitav Ghosh :

Ethos en Inde a une compréhension et un impact spécifiques. Le territoire indien couvre différentes zones géographiques, langues, cultures, religions, anciennes traditions et races. L'ethos indien est basé sur la "réalité sociale" en Inde. La culture indienne se reflète principalement dans l'hindouisme. Les écritures comme les Vedas, les Upanishads, les Puranas et le Bhagavad Gita ont impressionné le mode de vie de la majorité des habitants de l'Inde.



Vishal Salve travaille à l'ANPP, Samaj's New Arts, Commerce and Science College, Parner en tant que professeur assistant en anglais. Il a 12 ans d'expérience dans l'enseignement de l'anglais. Ses domaines d'intérêt sont la littérature anglaise indienne, les techniques de communication, CALL, MAIL et ELLT. Ses 3 livres et 20 articles de recherche sont publiés à différents niveaux.



Amitav Ghosh :
Une étude de l'ethos indien dans la mer de pavots





Salve, Vishal

Dr. Vishal Salve
Mrs. Pournima Salve

10. Amitav Ghosh: Uno studio sull'etica indiana nel mare dei papaveri (Italian Edition)

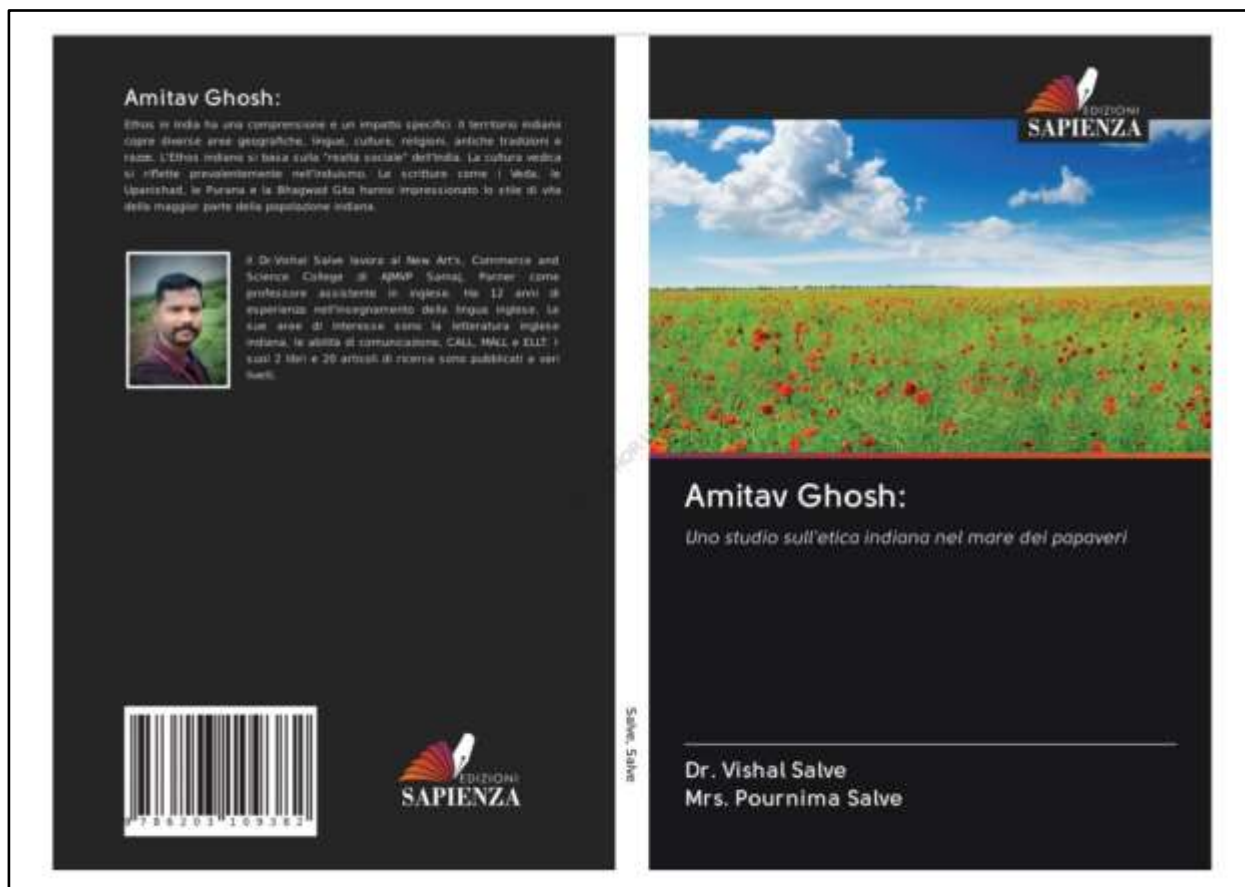

11. Amitav Ghosh: Studium indyjskiego etosu w morzu maków (Polish Edition)

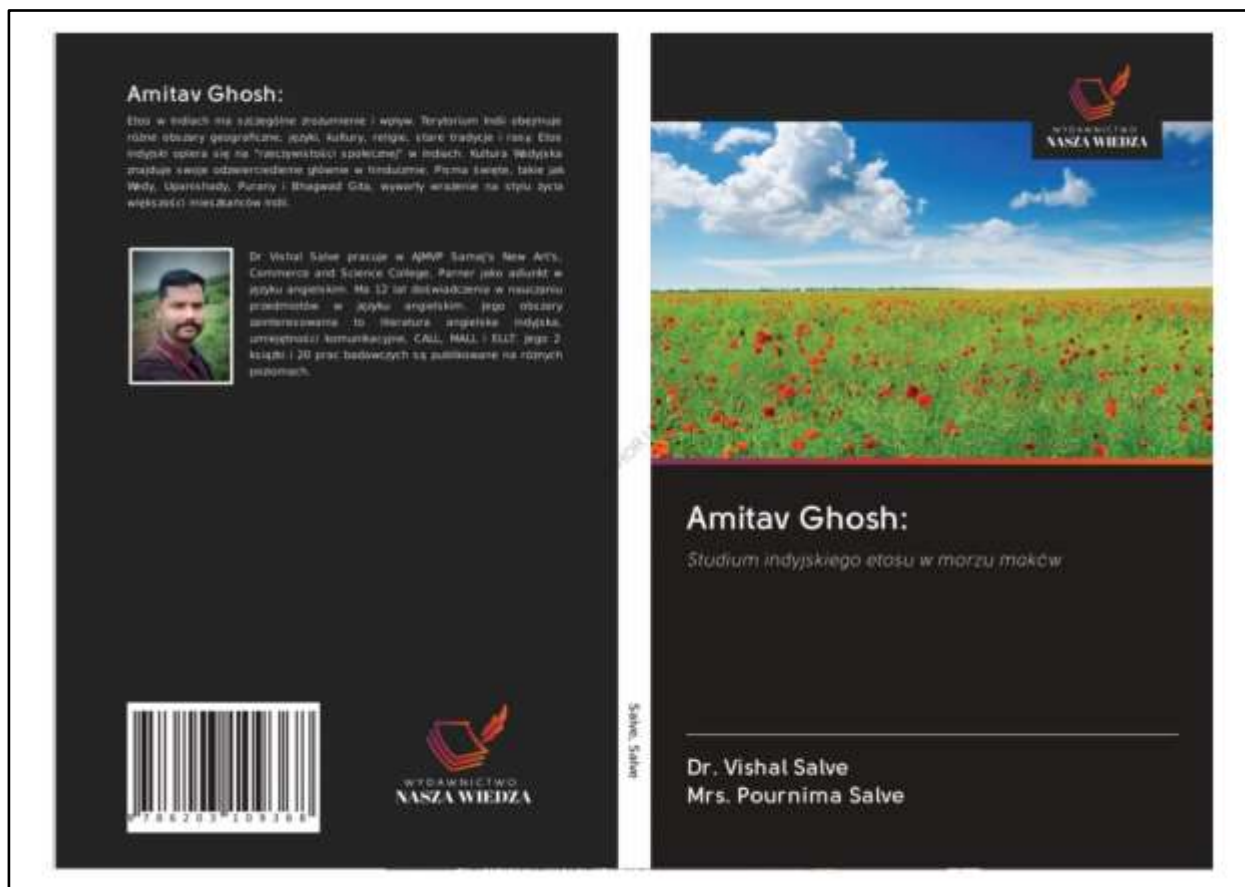

12. Amitav Ghosh: Un estudio del ethos indio en el Mar de Amapolas (Spanish Edition)

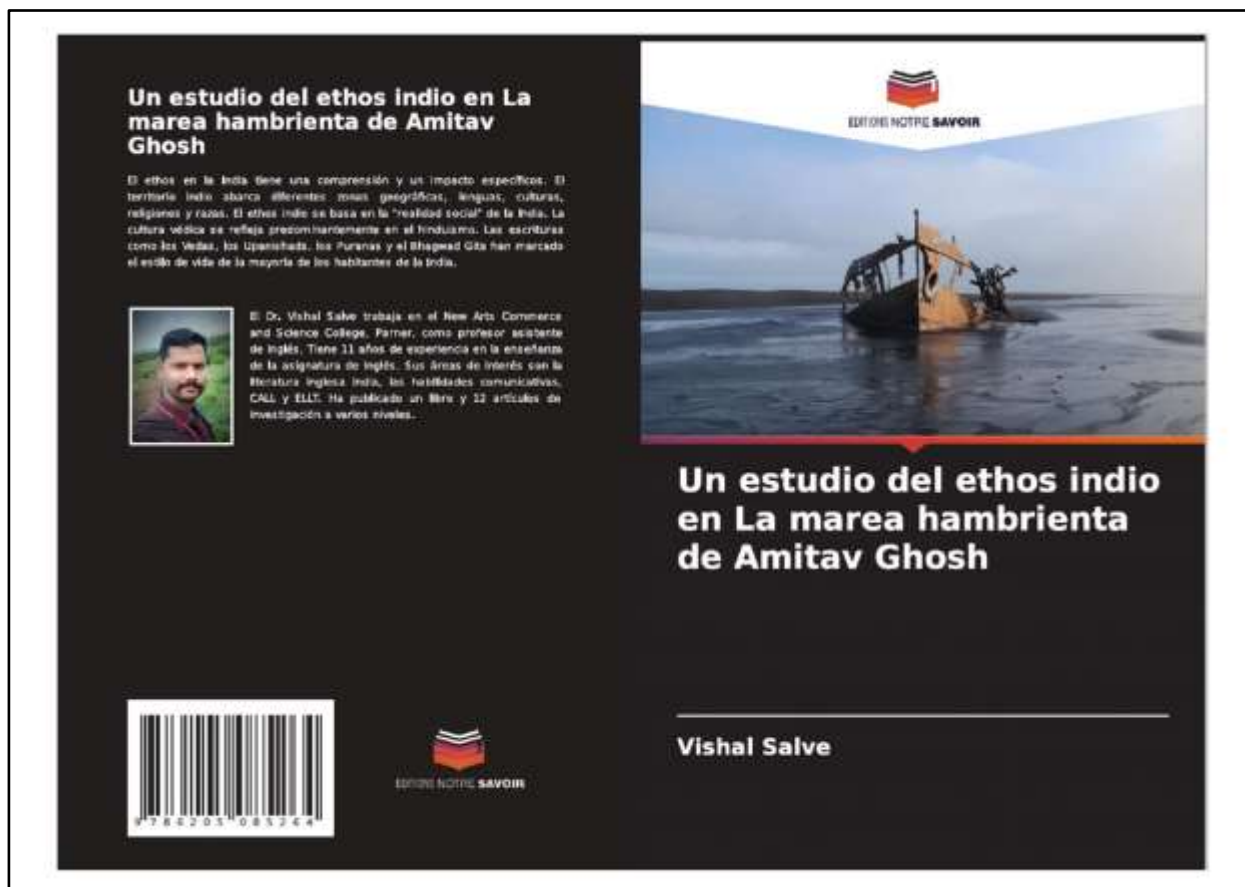

13. Physical and Human Geography

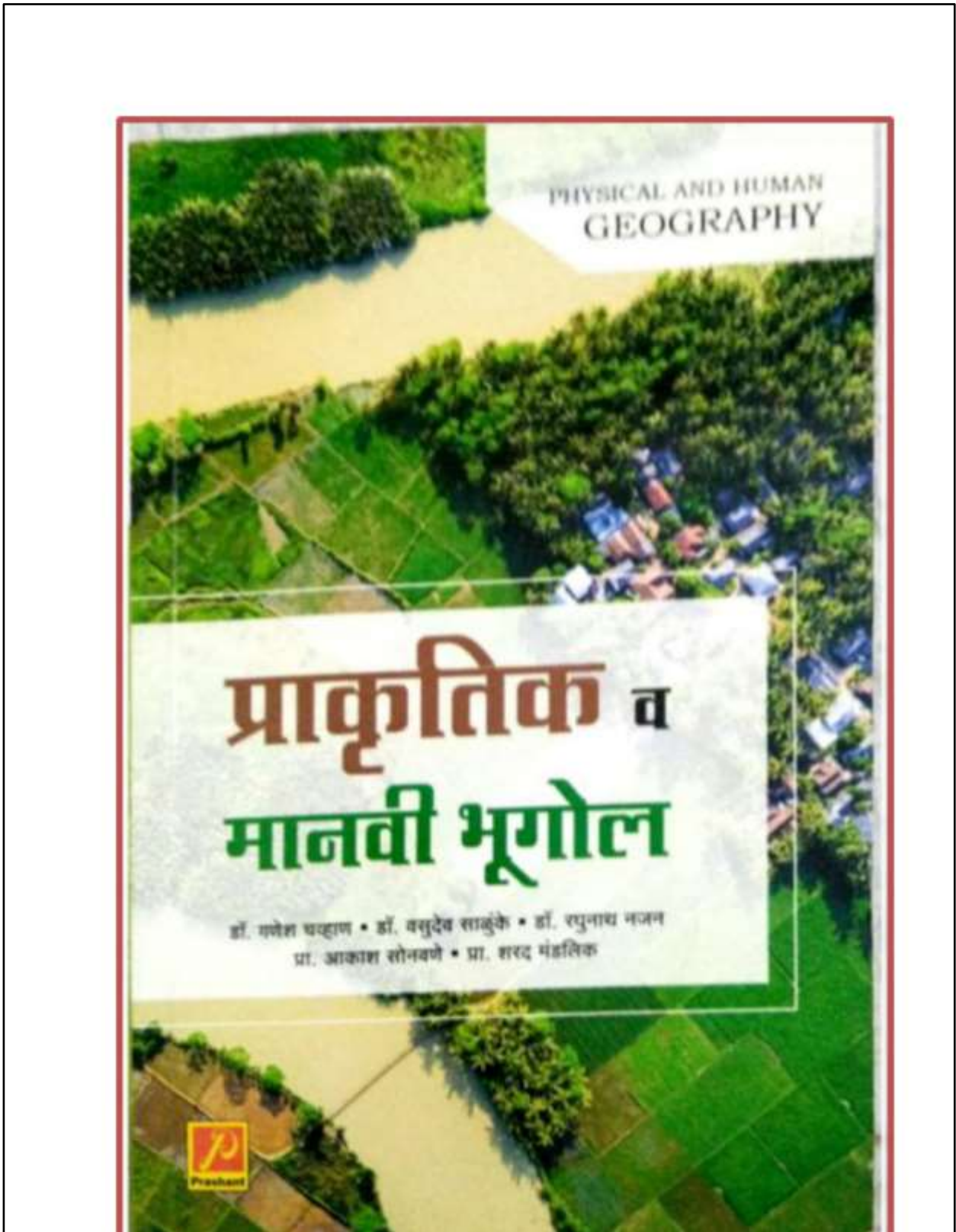

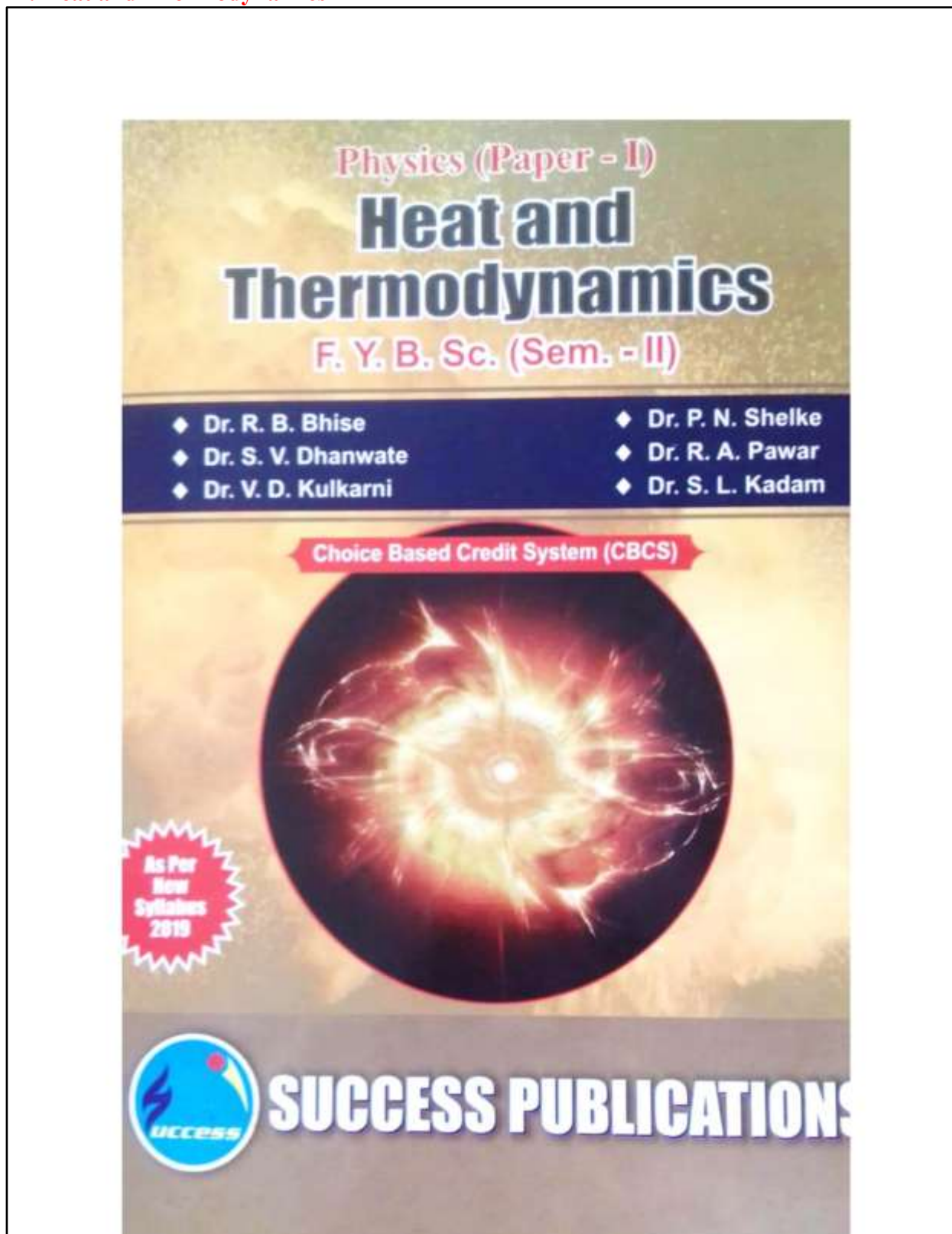
14. Heat and Thermodynamics

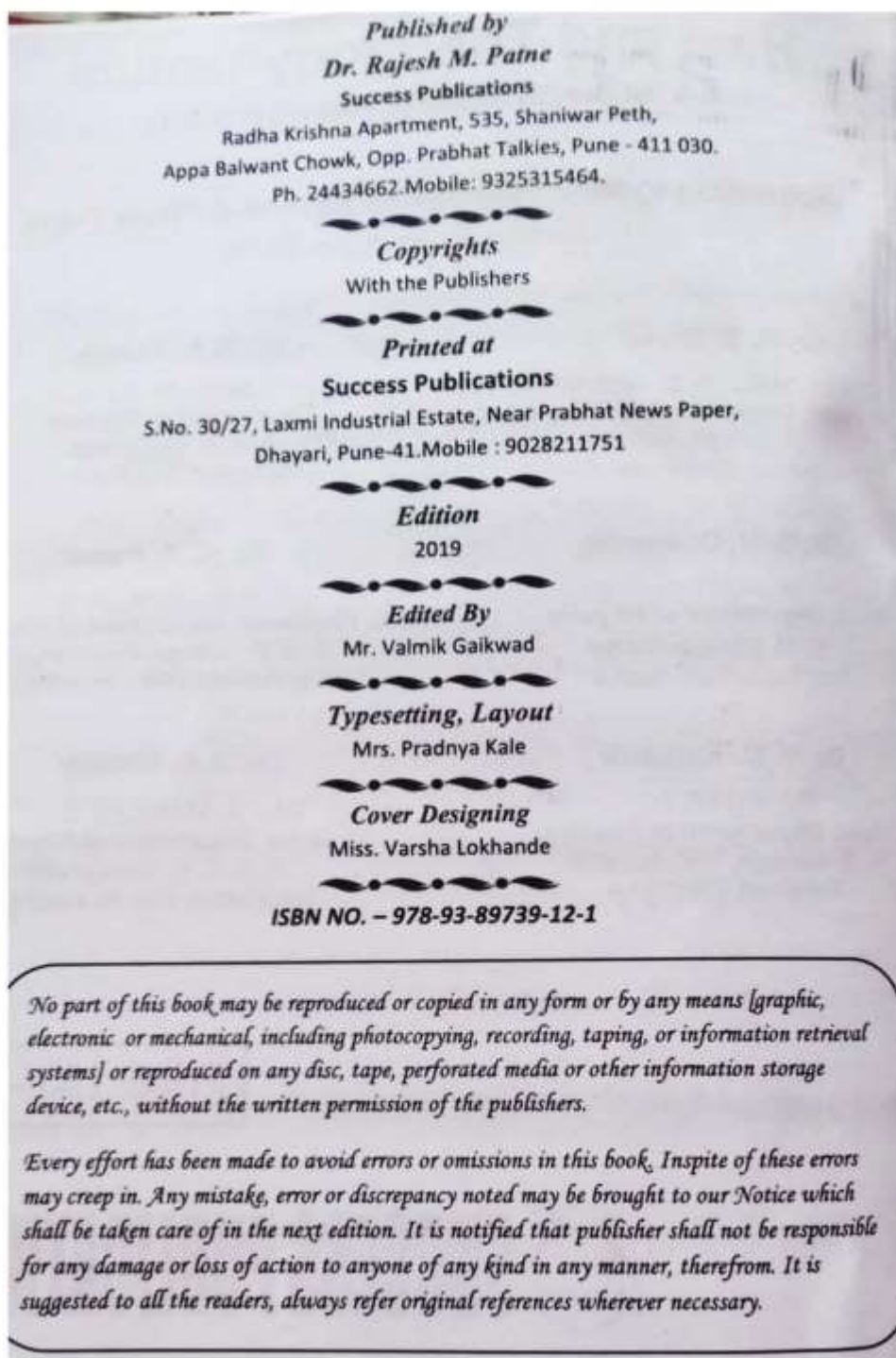

ISBN : 978-93-89739-12-1

SUCCESS PUBLICATIONS

Address : Radha Krishna Apartment, 535, Shaniwar Peth,
 Appa Balwant Chowk, Opp. Prabhat Theatre, Pune - 30.
 Ph. No. 24434662, Mobile : 9325315464
 E-mail : sharpgroup31@rediffmail.com
 Website : www.sharpmultinational.com

PT-3526

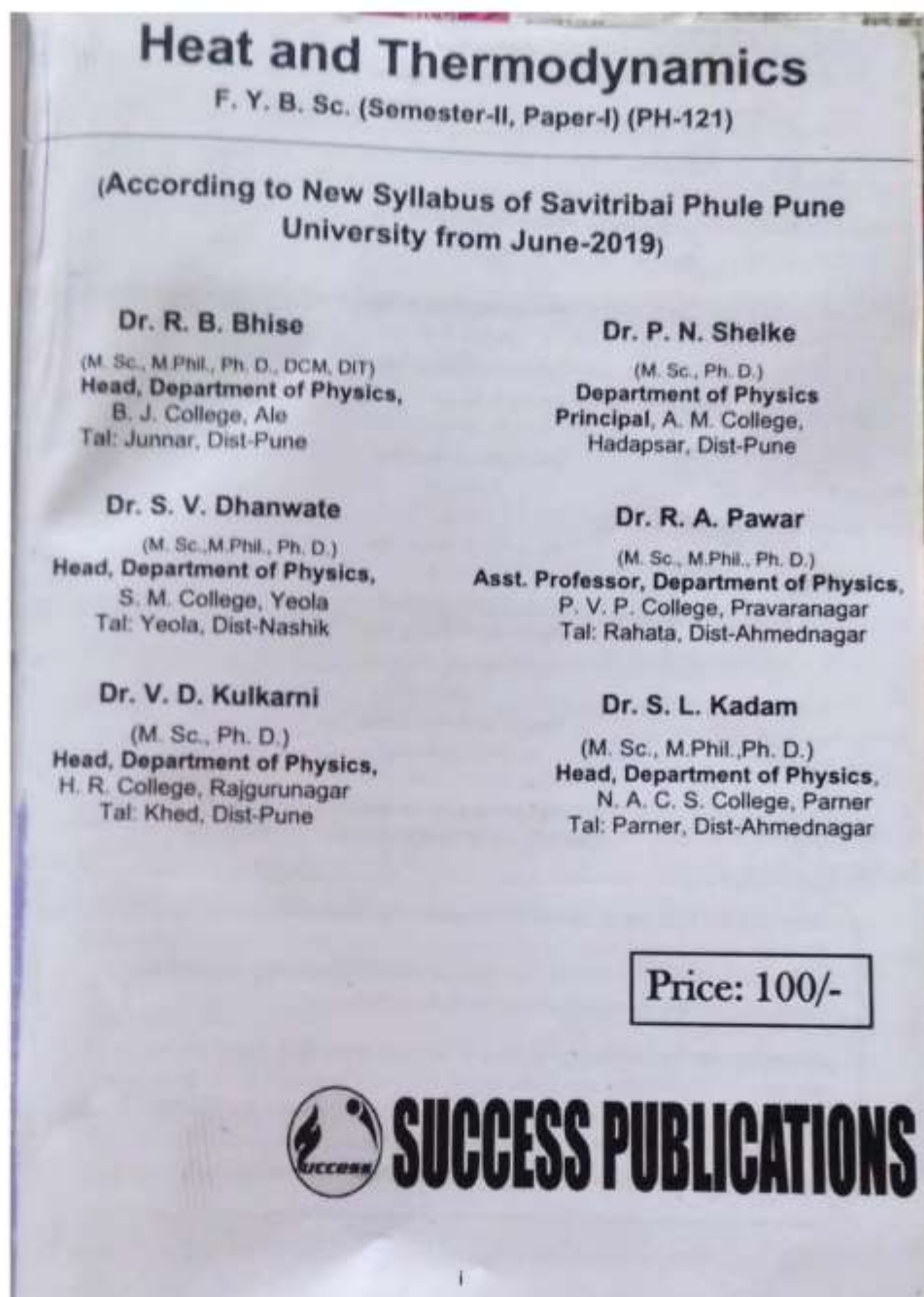

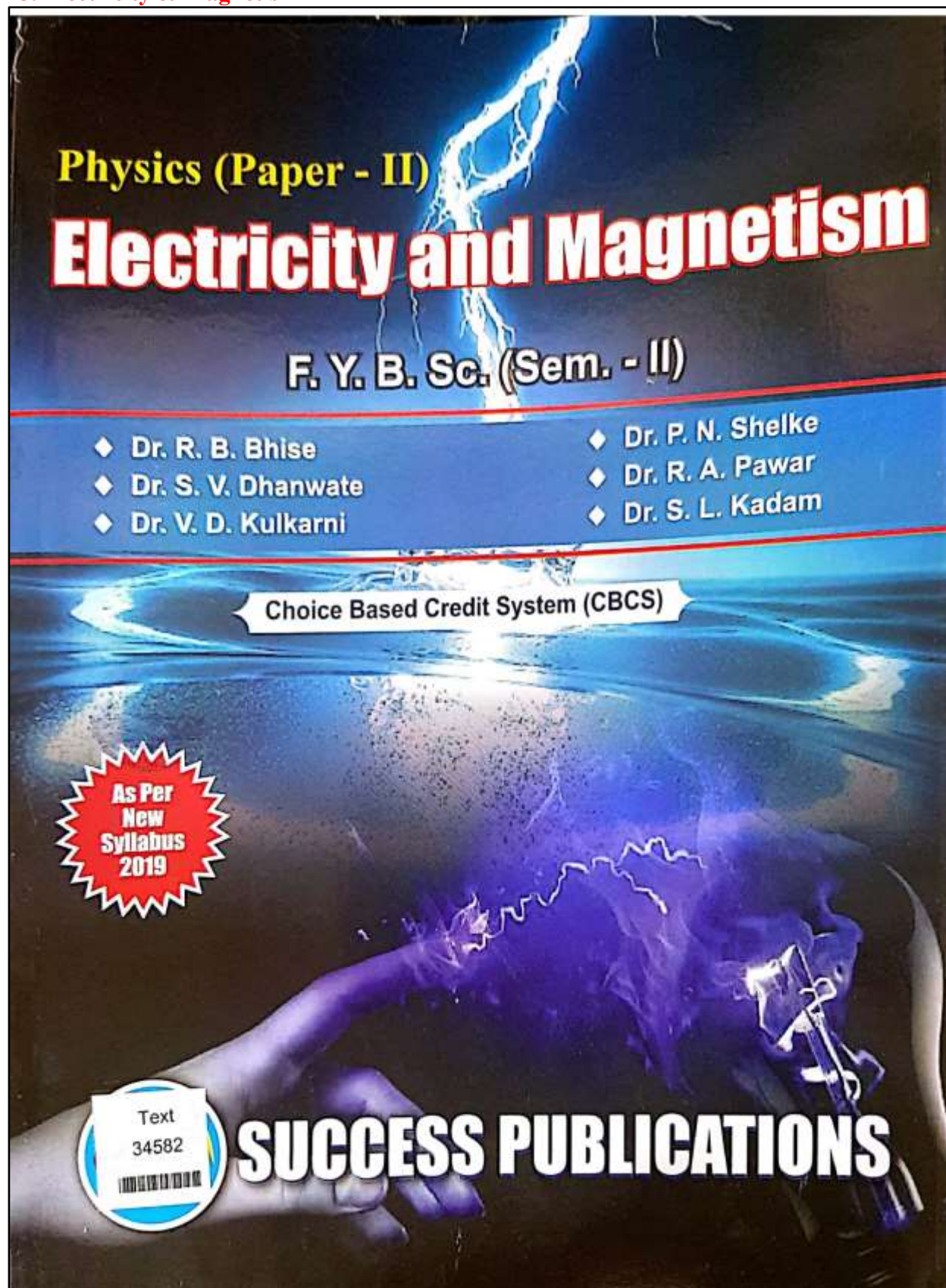
15. Electricity & Magnetism

Electricity and Magnetism

F. Y. B. Sc. (Semester-II, Paper-II) (PH-122)

(According to New Syllabus of Savitribai Phule Pune University from June-2019)

Dr. R. B. Bhise

(M. Sc., M. Phil., Ph. D., DCM, DIT)
Head, Department of Physics,
 B. J. College, Ale
 Tal: Junnar, Dist-Pune

Dr. P. N. Shelke

(M. Sc., Ph. D.)
Department of Physics
Principal, A. M. College,
 Hadapsar, Dist- Pune

Dr. S. V. Dhanwate

(M. Sc., M.Phil., Ph. D.)
Head, Department of Physics,
 S. M. College, Yeola Tal: Yeola,
 Dist-Nashik



Dr. R. A. Pawar

(M. Sc., M. Phil., Ph. D.)
Asst. Professor, Department of
Physics, V. P. College, Pravaranagar
 Tal: Rahata, Dist- Ahmednagar

Dr. V. D. Kulkarni

(M. Sc., Ph. D.)
Head, Department of Physics,
 H. R. College, Rajgurunagar
 Tal: Khed, Dist-Pune

34582

Dr. S. L. Kadam

(M. Sc., M.Phil., Ph. D.)
Head, Department of Physics,
 N. A. C. S. College, Parner
 Tal: Parner, Dist-Ahmednagar

Price: 100/-



SUCCESS PUBLICATIONS

Published by
Dr. Rajesh M. Patne
Success Publications

Radha Krishna Apartment, 535, Shaniwar Peth,
Appa Balwant Chowk, Opp. Prabhat Talkies, Pune - 411 030.
Ph. 24434662. Mobile: 9325315464.



Copyrights
With the Publishers



Printed at
Success Publications

S.No. 30/27, Laxmi Industrial Estate, Near Prabhat News Paper,
Dhayari, Pune-41. Mobile : 9028211751



Edition
2019



Edited By
Mr. Valmik Gaikwad



Typesetting, Layout
Mrs. Pradnya Kale



Cover Designing
Miss. Varsha Lokhande



ISBN NO. – 978-93-89739-13-8

No part of this book may be reproduced or copied in any form or by any means [graphic, electronic or mechanical, including photocopying, recording, taping, or information retrieval systems] or reproduced on any disc, tape, perforated media or other information storage device, etc., without the written permission of the publishers.

Every effort has been made to avoid errors or omissions in this book. In spite of these errors may creep in. Any mistake, error or discrepancy noted may be brought to our Notice which shall be taken care of in the next edition. It is notified that publisher shall not be responsible for any damage or loss of action to anyone of any kind in any manner, therefrom. It is suggested to all the readers, always refer original references wherever necessary.

The image displays a collection of 16 educational book covers arranged in a 4x4 grid. Each cover features the 'SUCCESS PUBLICATIONS' logo at the bottom. The books are:

- Row 1:** Analytical Chemistry - Paper II (F.Y.B.Sc. Sem. - II), Inorganic Chemistry (Paper I - I) (F.Y.B.Sc. Group - II), Analytical Geometry (F.Y.B.Sc. Group - II), Calculus - II (F.Y.B.Sc. Group - II).
- Row 2:** Animal Diversity-II (F.Y.B.Sc. Sem. - II), Cell Biology (F.Y.B.Sc. Sem. - II), Introduction to Human Geography (F.Y.B.Sc. Sem. - II), Population and Settlement Geography (F.Y.B.Sc. Sem. - II).
- Row 3:** Microbial Cultivation and Growth (F.Y.B.Sc. Sem. - II), Bacterial Cell and Biochemistry (F.Y.B.Sc. Sem. - II), Plant Life and Utilization - II (F.Y.B.Sc. Sem. - II), Principles of Plant Science (F.Y.B.Sc. Sem. - II).

ISBN : 978-93-89739-13-4

SUCCESS PUBLICATIONS

Address : Radha Krishna Apartment, 535, Shaniwar Peth, Appa Balwant Chowk, Opp. Prabhat Theatre, Pune - 30.
Ph. No. 24434662, **Mobile :** 9325315464
E-mail : sharpgroup31@rediffmail.com
Website : www.sharpmultinational.com

PT-3527

16. Plant Life and Utilization

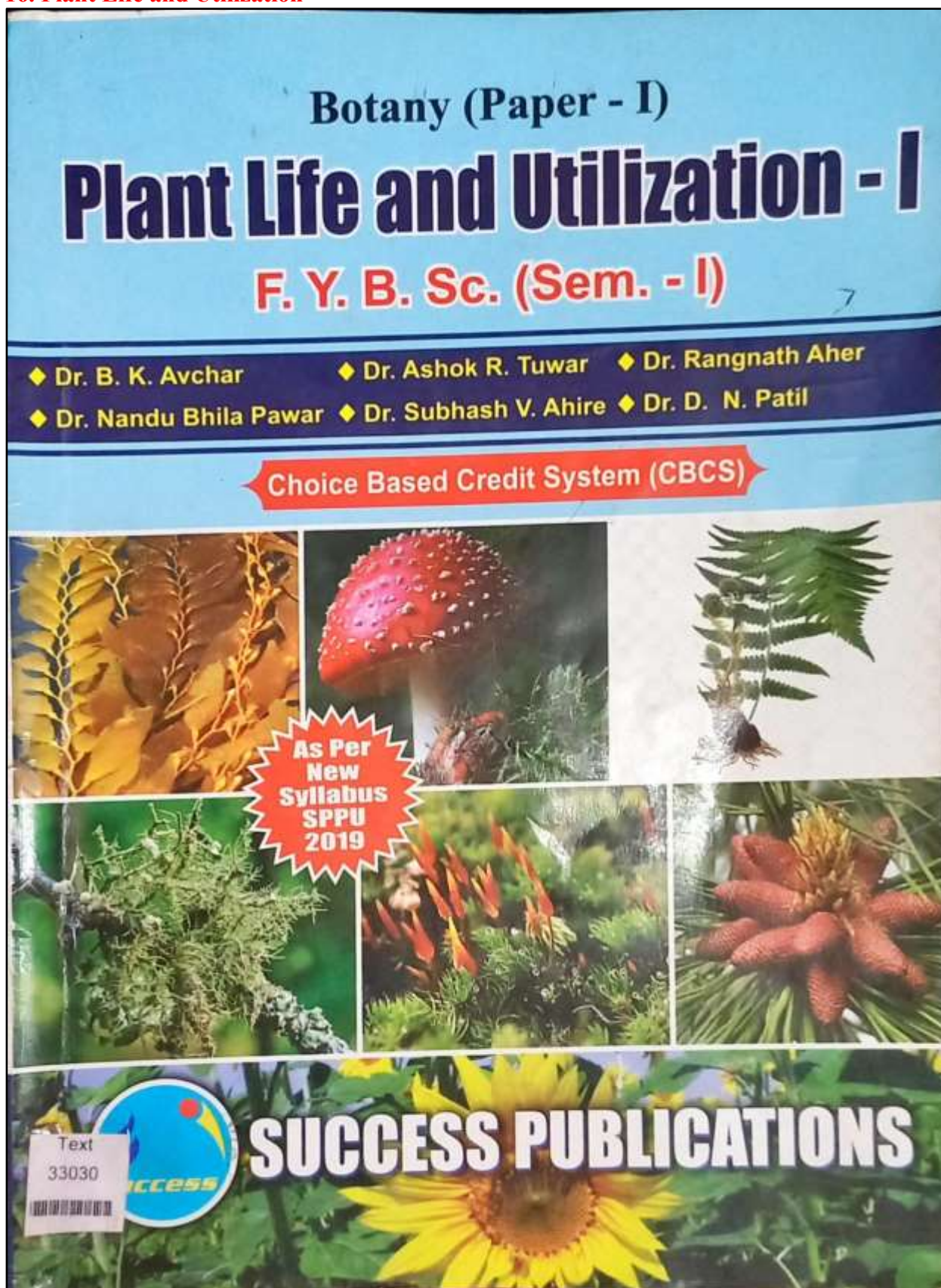

Botany (Paper – I)**PLANT LIFE AND UTILIZATION - I****F. Y. B. Sc. (Sem. - I)****Course Code (BO - 111)**

(According to New Syllabus of Savitribai Phule Pune University from
June-2019)

Authors**Dr. B. K. Avchar**

(M.Sc., Ph.D., L.L.B.)

Vidya Pratishthan's Arts, Science and
Commerce College, Baramati, Pune.**Dr. Rangnath Aher**

(M.Sc., Ph.D.)

New Arts, Commerce and Science
College, Parner, Ahmednagar.**Dr. Subhash V. Ahire**

(M.Sc., Ph.D.)

Nowrosjee Wadia College, Pune.

Dr. Ashok R. Tuwar

(M.Sc., Ph.D.)

Arts, Commerce & Science College,
Newasa, Ahmednagar.**Dr. Nandu Bhila Pawar**

(M.Sc., Ph.D.)

Loknete Vyankatrao Hiray Art's,
Commerce & Science College, Panchvati,
Nashik.**Dr. D. N. Patil**

(M.Sc., M.Ed., Ph.D.)

Bhartiya Jain Sanghatans, Arts, Science
and Commerce College, Wagholi, Pune.

33030

2019

Price : 100/-

**SUCCESS PUBLICATIONS**

Published by

Dr. Rajesh M. Patne

Success Publications

Radha Krishna Apartment, 535, Shaniwar Peth,
Appa Balwant Chowk, Opp. Prabhat Talkies, Pune - 411 030.
Ph. 24434662 Mobile : 9325315464.

Copyright

With the Publishers

Printed at

Success Publications

S.No. 30/27, Laxmi Industrial Estate, Near Prabhat News Paper,
Dhayari, Pune-41. Mobile : 9028211751

Edition

2019

Edited By

Mr. Valmik Gaikwad

Typesetting, Layout

Miss. Chaitali Gholap

Cover Designing

Mrs. Aparna Mali

ISBN NO. – 978-93-89066-35-7

No part of this book may be reproduced or copied in any form or by any means [graphic, electronic or mechanical, including photocopying, recording, taping, or information retrieval systems] or reproduced on any disc, tape, perforated media or other information storage device, etc., without the written permission of the publishers.

Every effort has been made to avoid errors or omissions in this book. In spite of this errors may creep in. Any mistake, error or discrepancy noted may be brought to our Notice which shall be taken care of in the next edition. It is Notified that publisher shall not be responsible for any damage or loss of action to anyone of any kind in any manner, therefrom. It is suggested to all the readers, always refer original references wherever necessary.

17. Concepts in Mammalian Physiology

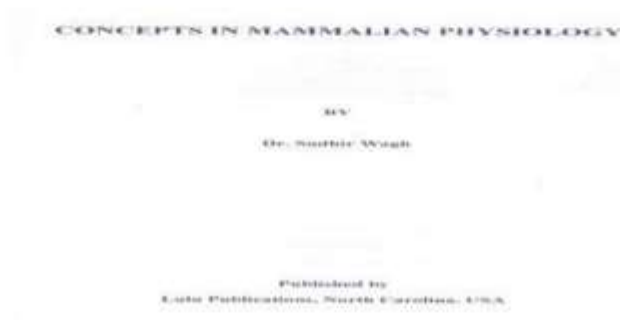
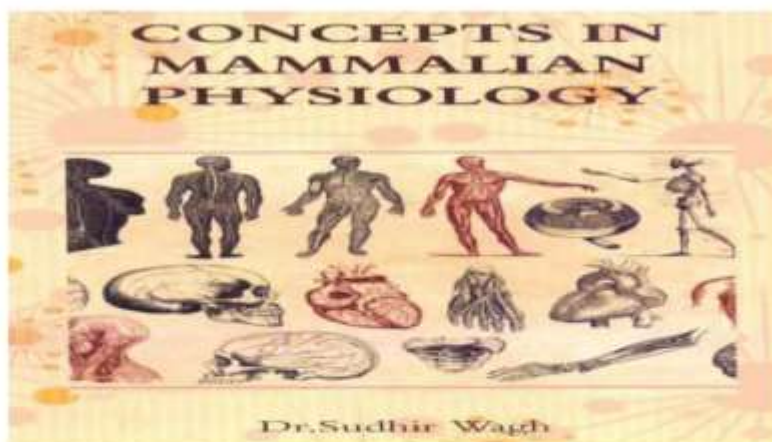

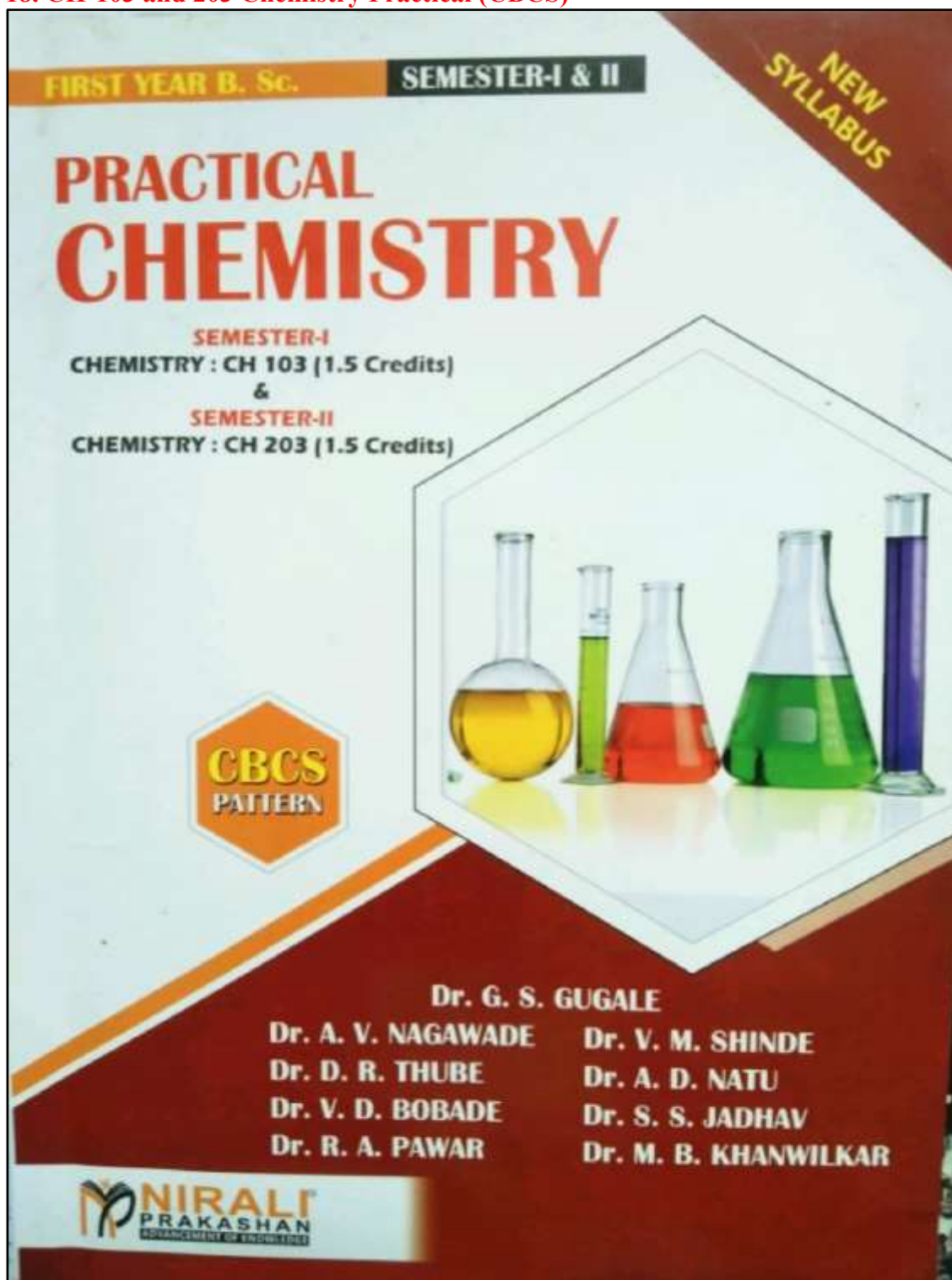
18. CH-103 and 203 Chemistry Practical (CBCS)

Dr. D. R. Thube, Persionel Copy

APPU New Syllabus

PRACTICAL CHEMISTRY

**First Year B. Sc. : CH-103 & 203
Semester I & II
New Syllabus as Per CBCS Pattern (Credit-1.5+1.5=3) June 2019**

Dr. G. S. GUGALE
Head and Associate Professor,
Department of Chemistry
Haribhai V. Desai College,
Pune.

Dr. A. V. NAGAWADE
Vice Principal and Associate Professor,
Ahmednagar College,
Ahmednagar.

Dr. D. R. THUBE
Vice Principal, Professor and Head,
Department of Chemistry and Research Centre,
New Arts, Commerce and Science College,
Parner, Dist. Ahmednagar.

Dr. V. D. BOBADE
Professor in Chemistry
H.P.T. Arts, R.Y.K. Science College,
Nashik.

Dr. R. A. PAWAR
Associate Professor in Chemistry
Prof. Ramkrishna More College,
Akurdi, Pune.

Dr. V. M. SHINDE
Head and Associate Professor
Department of Chemistry,
Annasaheb Waghire College,
Otur, Tal. Junner.

Dr. A. D. NATU
Ex. Head Department of Chemistry
Abasaheb Garware College,
Pune.

Dr. S. S. JADHAV
Ex. Principal,
Professor in Physical Chemistry,
New Arts, Commerce and Science College,
Shevgaon.

Dr. M. B. KHANWILKAR
Head and Associate Professor
K.M.C. College, Khopoli,
Dist. Raigad.

Price ₹ 100.00

NIRALI
PRAKASHAN
ADVANCEMENT OF KNOWLEDGE

ISBN 978-93-89406-51-1

F.Y.B.Sc. Practical Chemistry
 First Edition : July 2019
 C : Authors

The text of this publication, or any part thereof, should not be reproduced or transmitted in any form or stored in any computer storage system or device for distribution including photocopying, recording, taping or information retrieval system or reproduced on any disc, tape, perforated media or other information storage device etc. without the written permission of Authors with whom the rights are reserved. Breach of this condition is liable for legal action.
 Every effort has been made to avoid errors or omissions in this publication. In spite of this, errors may have crept in. Any mistake, error or discrepancy so noted and shall be brought to our notice shall be taken care of in the next edition. It is notified that neither the publisher nor the authors or seller shall be responsible for any damage or loss of action to any one, of any kind, in any manner, therefrom.

Published By :
NIRALI PRAKASHAN
 Abhyudaya Pragati, 1312 Shiveji Nagar,
 Off J.M. Road, PUNE - 411005.
 Tel - (020) 25512336/37/39. Fax - 25511379
 Email : niralipune@pragationline.com

Polyplate

Printed By :
SHIVANI PRINTERS
 1311, Kinara Coop. Housing,
 Kosba Peth, Pune 411 011
 Phone : (020) 24577245

> DISTRIBUTION CENTRES

PUNE
Nirali Prakashan : 119, Budhwar Peth, Jogeshwari Mandir Lane, Pune 411002, Maharashtra
 Tel : (020) 2445 2044, 66022708, Fax : (020) 2445 1538
 Email : bookorder@pragationline.com, niralilocal@pragationline.com
Nirali Prakashan : S. No. 28/27, Dhyari, Near Pari Company, Pune 411041
 Tel : (020) 24690204 Fax : (020) 24690316
 Email : dhyari@pragationline.com, bookorder@pragationline.com

MUMBAI
Nirali Prakashan : 385, S.V.P. Road, Rasdhara Co-op. Hsg. Society Ltd.,
 Girgaum, Mumbai 400004, Maharashtra
 Tel : (022) 2385 6339 / 2386 9976. Fax : (022) 2386 9976
 Email : niralimumbai@pragationline.com

> DISTRIBUTION BRANCHES

JALGAON
Nirali Prakashan : 34, V. V. Gotani Market, Navi Peth, Jalgaon 425002,
 Maharashtra, Tel : (0257) 222 0395, Mob : 94234 91860

KOLHAPUR
Nirali Prakashan : New Mahadvar Road, Kedar Plaza, 1st Floor Opp. IDBI Bank
 Kolhapur 416 012, Maharashtra, Mob : 9850046155

NAGPUR
Pratibha Book Distributors : Above Maratha Mandir, Shop No. 3, First Floor,
 Rani Jhanshi Square, Sitabuldi, Nagpur 440012, Maharashtra
 Tel : (0712) 254 7129

DELHI
Nirali Prakashan : 4593/21, Basement, Aggarwal Lane 15, Ansari Road, Daryaganj
 Near Times of India Building, New Delhi 110002 Mob : 08505972553

BENGALURU
Nirali Prakashan : Maitri, Ground Floor, Java Apartments No. 99,
 6th cross, 6th main Malleeswaram,
 Bengaluru - 560003 Mob : 9449043034
 Email : niralibangalore@pragationline.com

CHENNAI
Pragati Books : 9/1, Montieth Road, Behind Taas Mahal, Egmore,
 Chennai 600008 Tamil Nadu, Tel : (044) 6518 3535,
 Mob : 94440 01782 / 98450 21552 / 98805 82331,
 Email : bharatsavita@yehoo.com

Note : Every possible effort has been made to avoid errors or omissions in this book. In spite this, errors may have crept in. Any type of error or mistake so noted, and shall be brought to our notice, shall be taken care of in the next edition. It is notified that neither the publisher nor the author or book seller shall be responsible for any damage or loss of action to any one of any kind, in any manner, therefrom. The reader must cross check all the facts and contents with original Government notification or publications.

niralipune@pragationline.com | www.pragationline.com
 Also find us on | www.facebook.com/niralibooks

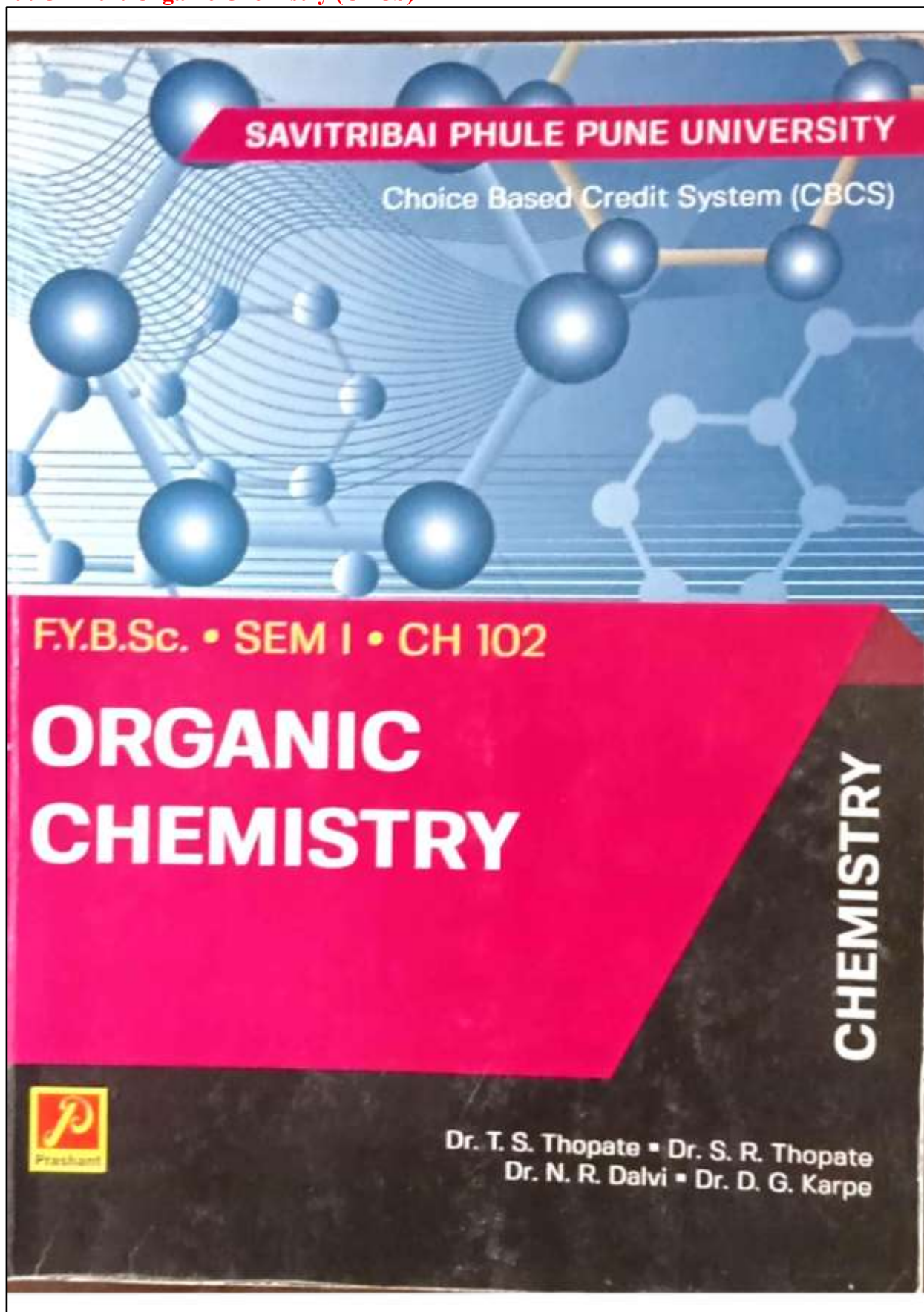
19. CH-102: Organic Chemistry (CBCS)



**Prashant
Publications**

© Authors

ORGANIC CHEMISTRY

F.Y.B.Sc. | Sem I | CH 102

Publisher and Printer

Prashant Publications
3, Pratap Nagar, Shri Sant Dnyaneshwar Mandir Road,
Near Nutan Maratha College, Jalgaon 425001.

• Phone • Website • E-mail

(0257) 2235520, 2232800
www.prashantpublications.com
prashantpublication.jal@gmail.com

• First Edition • ISBN • Type Setting

July. 2019
978-93-88769-93-8
Prashant Publication

Price : ₹ 80/-

All rights reserved. No part of this publication may be reproduced, stored in a retrieval system or transmitted, in any form or by any means, electronic, mechanical, photocopying (xerox copy), recording or otherwise, without the prior permission.

ii

Contents

1. Fundamentals of Organic Chemistry.....	07
1.1. Physical Effects	
1.2. Electronic Displacements	
1.3. Electromeric Effect	
1.4. Resonance or Mesomeric Effect	
1.5. Hyperconjugation	
1.6. Cleavage of Bonds	
1.7. Structure, Shape and Reactivity of organic molecules	
1.8. Reactive Intermediates	
1.9. Strength of organic acids and bases	
1.10. Aromaticity: Benzenoid and Huckel's Rule	
2. Stereochemistry	34
2.1. Classification of Isomers	
2.2. Representation of Organic molecules	
2.3. Conformational isomerism in alkanes	
2.4. Configuration Isomerism	
2.5. Physical properties of geometrical isomers	
2.6. Chemical properties of geometrical isomers	
2.7. Optical Isomers	
2.8. Chirality	
2.9. Optical Isomerism	
2.10. Enantiomerism	
2.11. Diastereomerism	
2.12. Meso compounds	
2.13. Erythro and Threo	
2.14. D and L nomenclature	
2.15. Configuration	
3. Aliphatic Hydrocarbons	69
3.1. Nomenclature	
3.2. Classification of Carbon and Hydrogen atoms	
3.3. Isomerism in alkanes	
3.4. Physical Properties	

- 3.5. Preparation of alkanes
- 3.6. Reactions of alkanes
- 3.7. Introduction
- 3.8. Nomenclature of Alkenes
- 3.9. Physical properties of alkenes
- 3.10. Preparation of alkenes
- 3.11. Reactions of alkenes
- 3.12. Introduction
- 3.13. Nomenclature of alkynes
- 3.14. Physical properties of alkynes
- 3.15. Preparation of alkynes
- 3.16. Reactions of alkynes

20. CH-103 and 203 Chemistry Practical (CBCS)

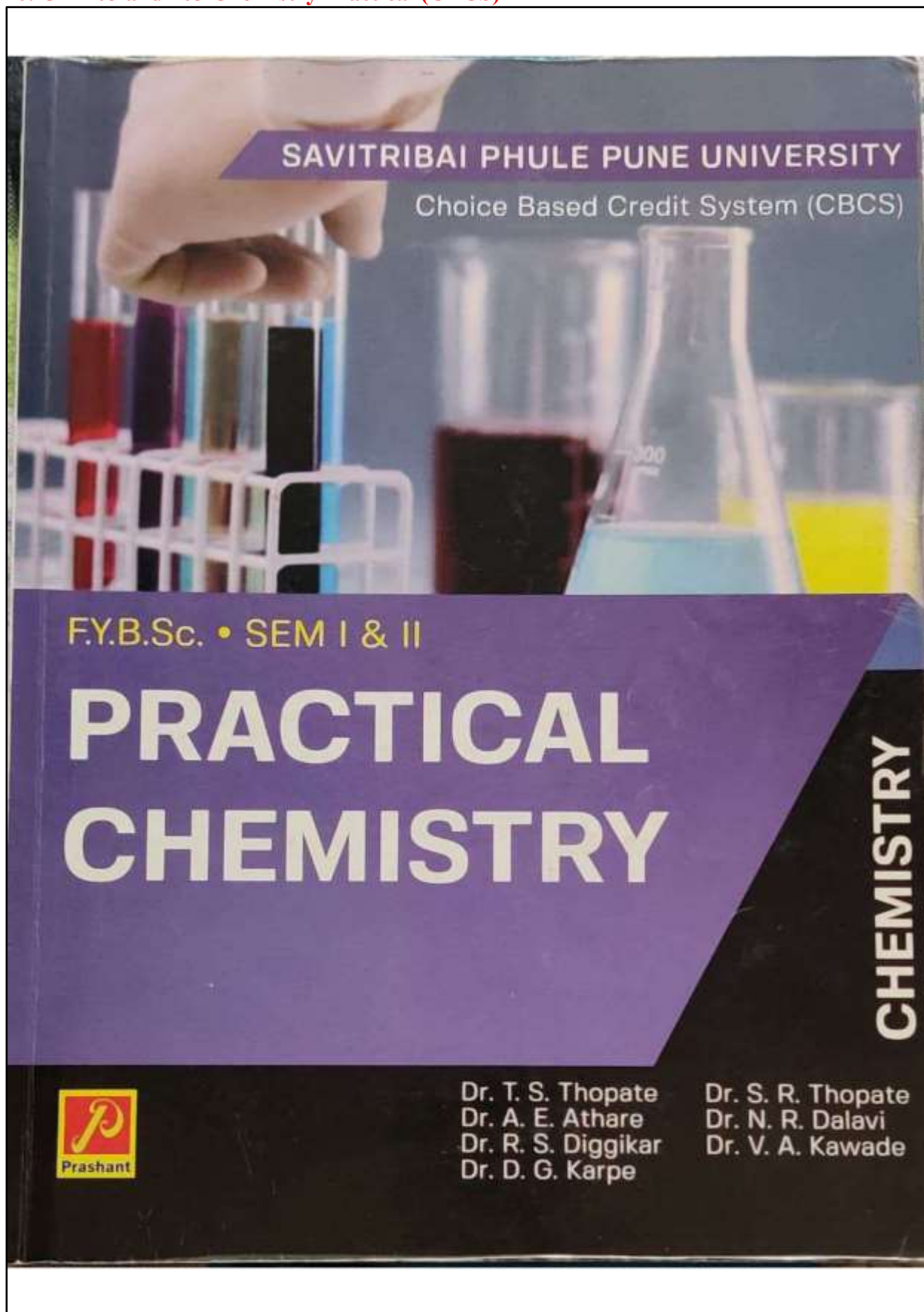



**Prashant
Publications**

© Reserved

PRACTICAL CHEMISTRY
F.Y.B.Sc. | Sem I & II | CH - 103 & 203

Publisher and Printer

Prashant Publications
3, Pratap Nagar, Shri Sant Dnyaneshwar Mandir Road,
Near Nutan Maratha College, Jalgaon 425001.

. Phone . Website . E-mail

(0257) 2235520, 2232800
www.prashantpublications.com
prashantpublication.jal@gmail.com

. First Edition . ISBN . Type Setting

July. 2019
978-93-85664-95-3
Prashant Publication

Price : ₹ 110/-

All rights reserved. No part of this publication may be reproduced, stored in a retrieval system or transmitted, in any form or by any means, electronic, mechanical, photocopying (xerox copy), recording or otherwise, without the prior permission.

ii

Contents

CH-103: Chemistry Practical

SECTION-I: CHEMICAL AND LAB SAFETY

Practical No. 1	9
Toxicity of compounds used in chemistry laboratory.	
Practical No. 2	11
Safety symbol on labels of pack of chemicals and its meaning.	
Practical No. 3	13
MSDS sheets and its use for handling hazardous chemicals.	
Practical No. 4	15
Precautions in handling hazardous substances in laboratory.	

SECTION-II: PHYSICAL CHEMISTRY

Thermochemistry (Any Three)

Practical No. 1	17
To determine the heat capacity of calorimeter for different volumes.	
Practical No. 2	19
To determine the enthalpy of ionization of Hydrochloric acid.	
Practical No. 3	21
To determine the enthalpy of ionization of acetic acid.	
Practical No. 4	23
To determine the integral enthalpy of solution of salts ($\text{KNO}_3/\text{NH}_4\text{Cl}$).	
Practical No. 5	25
To determine of enthalpy of hydration of copper sulphate.	
Practical No. 6	27
To study of the solubility of benzoic acid in water and determination of ΔH .	
Practical No. 7	30
To measure of pH of different solutions like aerated drinks, fruit juices, shampoos and soaps using pH meter.	

Ionic Equilibria (Any Three)

Practical No. 8	33
To prepare the buffer solution of sodium acetate-acetic acid and determine its buffer capacity.	

SECTION-III: ORGANIC CHEMISTRY

Practical No. 1	36
Organic Qualitative Analysis, Detection of extra elements (N, S, Cl, Br, I) of organic compound (One or Two elements can be given) Any Three	
Practical No. 2	51
a) Separation of amino acids by paper chromatography. b) Separation of sugars by paper chromatography.	

CH-203: Chemistry Practical**SECTION-I: INORGANIC CHEMISTRY****Volumetric Analysis**

Practical No. 1	59
Estimation of sodium carbonate and sodium hydrogen carbonate present in a mixture.	
Practical No. 2	62
To Standardise KMnO_4 solution and find strength of KMnO_4 using Oxalic Acid.	
Practical No. 3	65
Estimation of water of crystallization in Mohr's salt by titrating with KMnO_4 .	
Practical No. 4	67
Estimation of Fe (II) ions by titrating it with $\text{K}_2\text{Cr}_2\text{O}_7$ using internal indicator.	
Practical No. 5	70
To sketch the polar plots of S and P orbital's.	
Synthesis of Commercially Imp. Inorganic Compounds (Any Two)	
Practical No. 6	72
Synthesis of potash alum from scrap aluminum metal.	
Practical No. 7	74
Synthesis of Mohr's salt [Ferrous ammonium sulphate hexahydrate].	

Practical No. 8.....	76	5
Preparation of dark red inorganic pigment cuprous oxide (Cu_2O)		
Practical No. 9.....	77	5
Synthesis of $\text{FeSO}_4 \cdot 7\text{H}_2\text{O}$ (ferrous (II) sulphate heptahydrate)		
Analysis Of Commercial Products (Any One)		
Practical No. 10.....	78	7
Estimation of Calcium from Calcium Supplementary Tablet		
Practical No. 11.....	81	7
Estimation of acid neutralizing capacity of antacid		
Practical No. 12.....	85	
Estimation of Cu (II) from brass alloy by iodometrically		
SECTION-III: ORGANIC CHEMISTRY		
<u>Volumetric Analysis</u>		
Practical No. 1.....	92	8
Purification of organic compound by crystallization (water or alcohol)		
Practical No. 2.....	94	✓
Purification of Liquids by Distillation (Any two compounds of each)		
<u>Organic Preparations: Mechanism of reaction involved</u>		
(Green Chemistry Approach)		
Practical No. 1.....	95	9
Bromination of Cinnamic acid using sodium bromide and Sodium bromate.		
Practical No. 2.....	97	
Bromination of acetanilide using KBr and Ceric ammonium nitrate in aq. medium		
<u>Preparations of Derivatives:</u>		
Practical No. 1.....	99	
Semicarbazone derivatives of aldehydes and ketones and measure the R_f value of derivative		
Practical No. 2.....	101	
Preparation of Oxime derivative		
Practical No. 3.....	102	
Preparation of 2:4 DNP derivative		

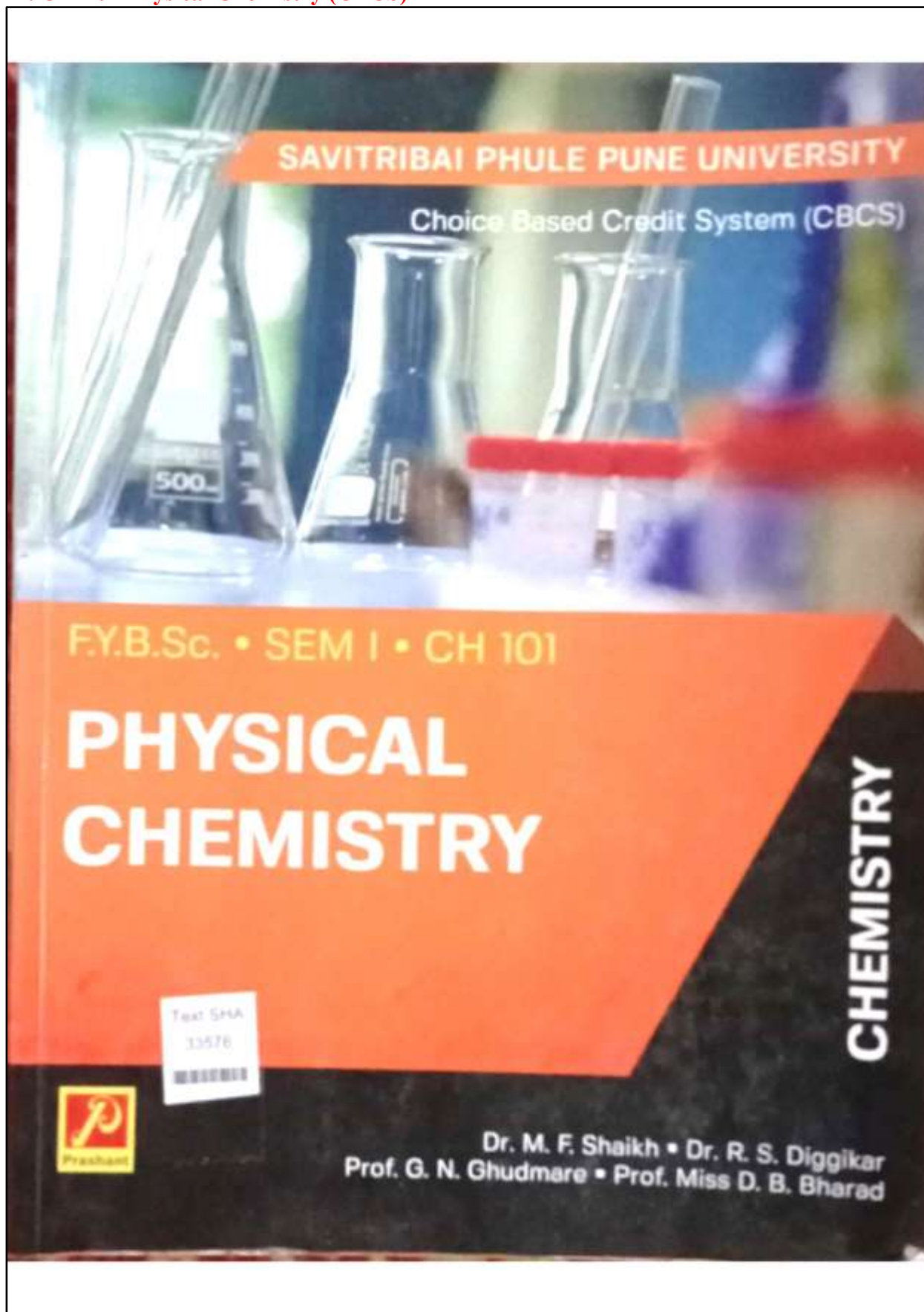
21. CH-101 Physical Chemistry (CBCS)



**Prashant
Publications**

© Reserved

PHYSICAL CHEMISTRY

F.Y.B.Sc. | Sem I | CH 101

Publisher and Printer

Prashant Publications
3, Pratap Nagar, Shri Sant Dnyaneshwar Mandir Road,
Near Nutan Maratha College, Jalgaon 425001.

• Phone • Website • E-mail

(0257) 2235520, 2232800
www.prashantpublications.com
prashantpublication.jal@gmail.com

• First Edition • ISBN • Type Setting

August, 2019
978-93-88769-92-1
Prashant Publication

Price : ₹ 80/-

All rights reserved. No part of this publication may be reproduced, stored in a retrieval system or transmitted, in any form or by any means, electronic, mechanical, photocopying (xerox copy), recording or otherwise, without the prior permission.

||

Contents

1. Chemical Energetics	07
2. Chemical Equilibrium	25
3. Ionic Equilibria	59

33576

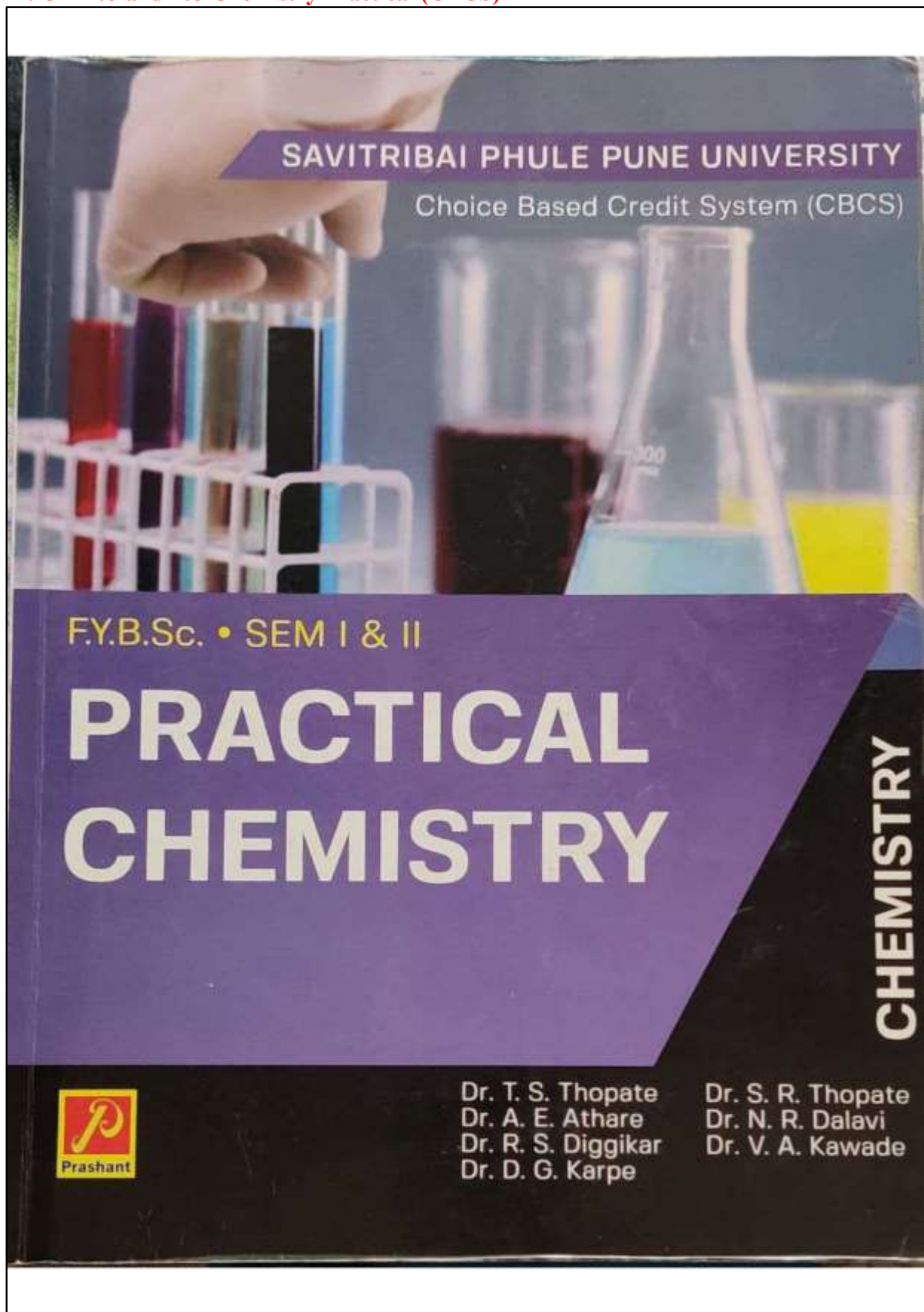
22. CH-103 and 203 Chemistry Practical (CBCS)



**Prashant
Publications**

© Reserved

PRACTICAL CHEMISTRY
F.Y.B.Sc. | Sem I & II | CH - 103 & 203

Publisher and Printer

Prashant Publications
3, Pratap Nagar, Shri Sant Dnyaneshwar Mandir Road,
Near Nutan Maratha College, Jalgaon 425001.

. Phone . Website . E-mail

(0257) 2235520, 2232800
www.prashantpublications.com
prashantpublication.jal@gmail.com

. First Edition . ISBN . Type Setting

July. 2019
978-93-85664-95-3
Prashant Publication

Price : ₹ 110/-

All rights reserved. No part of this publication may be reproduced, stored in a retrieval system or transmitted, in any form or by any means, electronic, mechanical, photocopying (xerox copy), recording or otherwise, without the prior permission.

ii

Contents

CH-103: Chemistry Practical

SECTION-I: CHEMICAL AND LAB SAFETY

Practical No. 1	9
Toxicity of compounds used in chemistry laboratory.	
Practical No. 2	11
Safety symbol on labels of pack of chemicals and its meaning.	
Practical No. 3	13
MSDS sheets and its use for handling hazardous chemicals.	
Practical No. 4	15
Precautions in handling hazardous substances in laboratory.	

SECTION-II: PHYSICAL CHEMISTRY

Thermochemistry (Any Three)

Practical No. 1	17
To determine the heat capacity of calorimeter for different volumes.	
Practical No. 2	19
To determine the enthalpy of ionization of Hydrochloric acid.	
Practical No. 3	21
To determine the enthalpy of ionization of acetic acid.	
Practical No. 4	23
To determine the integral enthalpy of solution of salts ($\text{KNO}_3/\text{NH}_4\text{Cl}$).	
Practical No. 5	25
To determine of enthalpy of hydration of copper sulphate.	
Practical No. 6	27
To study of the solubility of benzoic acid in water and determination of ΔH .	
Practical No. 7	30
To measure of pH of different solutions like aerated drinks, fruit juices, shampoos and soaps using pH meter.	

Ionic Equilibria (Any Three)

Practical No. 8	33
To prepare the buffer solution of sodium acetate-acetic acid and determine its buffer capacity.	

SECTION-III: ORGANIC CHEMISTRY

Practical No. 1	36
Organic Qualitative Analysis, Detection of extra elements (N, S, Cl, Br, I) of organic compound (One or Two elements can be given) Any Three	
Practical No. 2	51
a) Separation of amino acids by paper chromatography. b) Separation of sugars by paper chromatography.	

CH-203: Chemistry Practical**SECTION-I: INORGANIC CHEMISTRY****Volumetric Analysis**

Practical No. 1	59
Estimation of sodium carbonate and sodium hydrogen carbonate present in a mixture.	
Practical No. 2	62
To Standardise KMnO_4 solution and find strength of KMnO_4 using Oxalic Acid.	
Practical No. 3	65
Estimation of water of crystallization in Mohr's salt by titrating with KMnO_4 .	
Practical No. 4	67
Estimation of Fe (II) ions by titrating it with $\text{K}_2\text{Cr}_2\text{O}_7$ using internal indicator.	
Practical No. 5	70
To sketch the polar plots of S and P orbital's.	
Synthesis of Commercially Imp. Inorganic Compounds (Any Two)	
Practical No. 6	72
Synthesis of potash alum from scrap aluminum metal.	
Practical No. 7	74
Synthesis of Mohr's salt [Ferrous ammonium sulphate hexahydrate].	

Practical No. 8.....	76	5
Preparation of dark red inorganic pigment cuprous oxide (Cu_2O)		
Practical No. 9.....	77	5
Synthesis of $\text{FeSO}_4 \cdot 7\text{H}_2\text{O}$ (ferrous (II) sulphate heptahydrate)		
<u>Analysis Of Commercial Products (Any One)</u>		
Practical No. 10.....	78	7
Estimation of Calcium from Calcium Supplementary Tablet		
Practical No. 11.....	81	7
Estimation of acid neutralizing capacity of antacid		
Practical No. 12.....	85	
Estimation of Cu (II) from brass alloy by iodometrically		
SECTION-III: ORGANIC CHEMISTRY		
<u>Volumetric Analysis</u>		
Practical No. 1.....	92	8
Purification of organic compound by crystallization (water or alcohol)		
Practical No. 2.....	94	✓
Purification of Liquids by Distillation (Any two compounds of each)		
<u>Organic Preparations: Mechanism of reaction involved (Green Chemistry Approach)</u>		
Practical No. 1.....	95	9
Bromination of Cinnamic acid using sodium bromide and Sodium bromate.		
Practical No. 2.....	97	
Bromination of acetanilide using KBr and Ceric ammonium nitrate in aq. medium		
<u>Preparations of Derivatives:</u>		
Practical No. 1.....	99	
Semicarbazone derivatives of aldehydes and ketones and measure the Rf value of derivative		
Practical No. 2.....	101	
Preparation of Oxime derivative		
Practical No. 3.....	102	
Preparation of 2:4 DNP derivative		

23. Prakashwata Swarup Ani Chintan

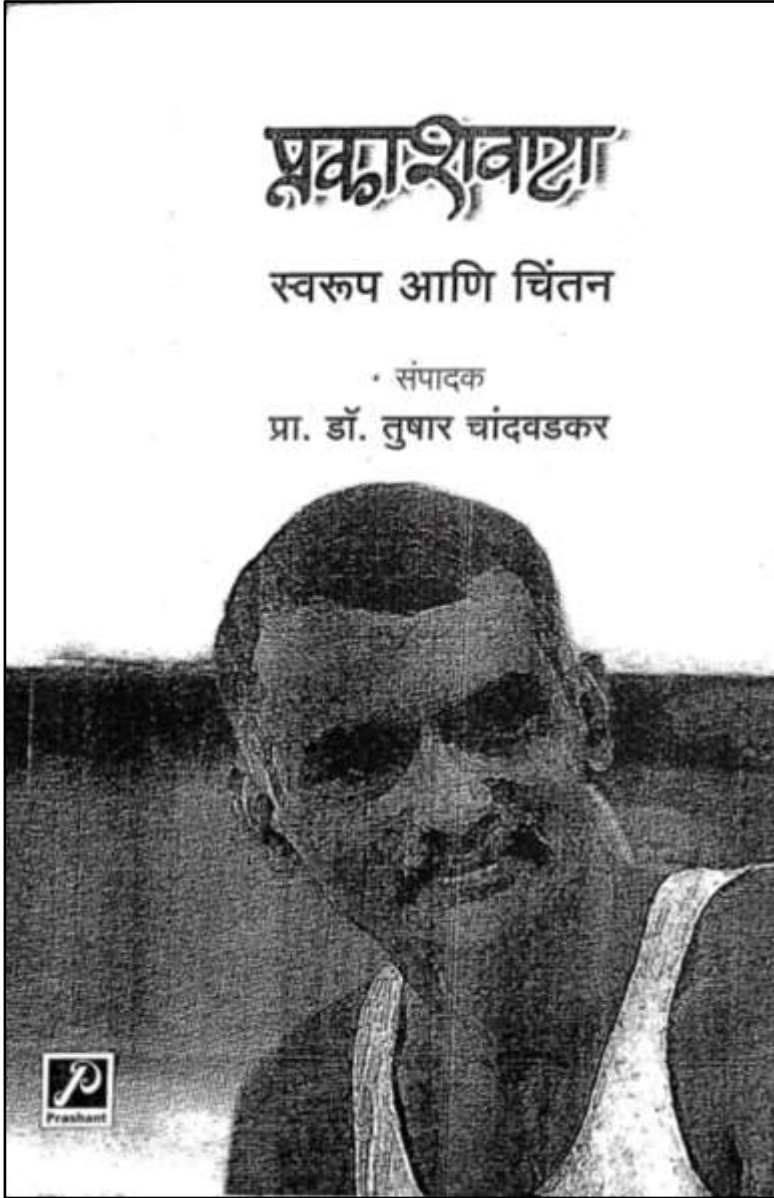

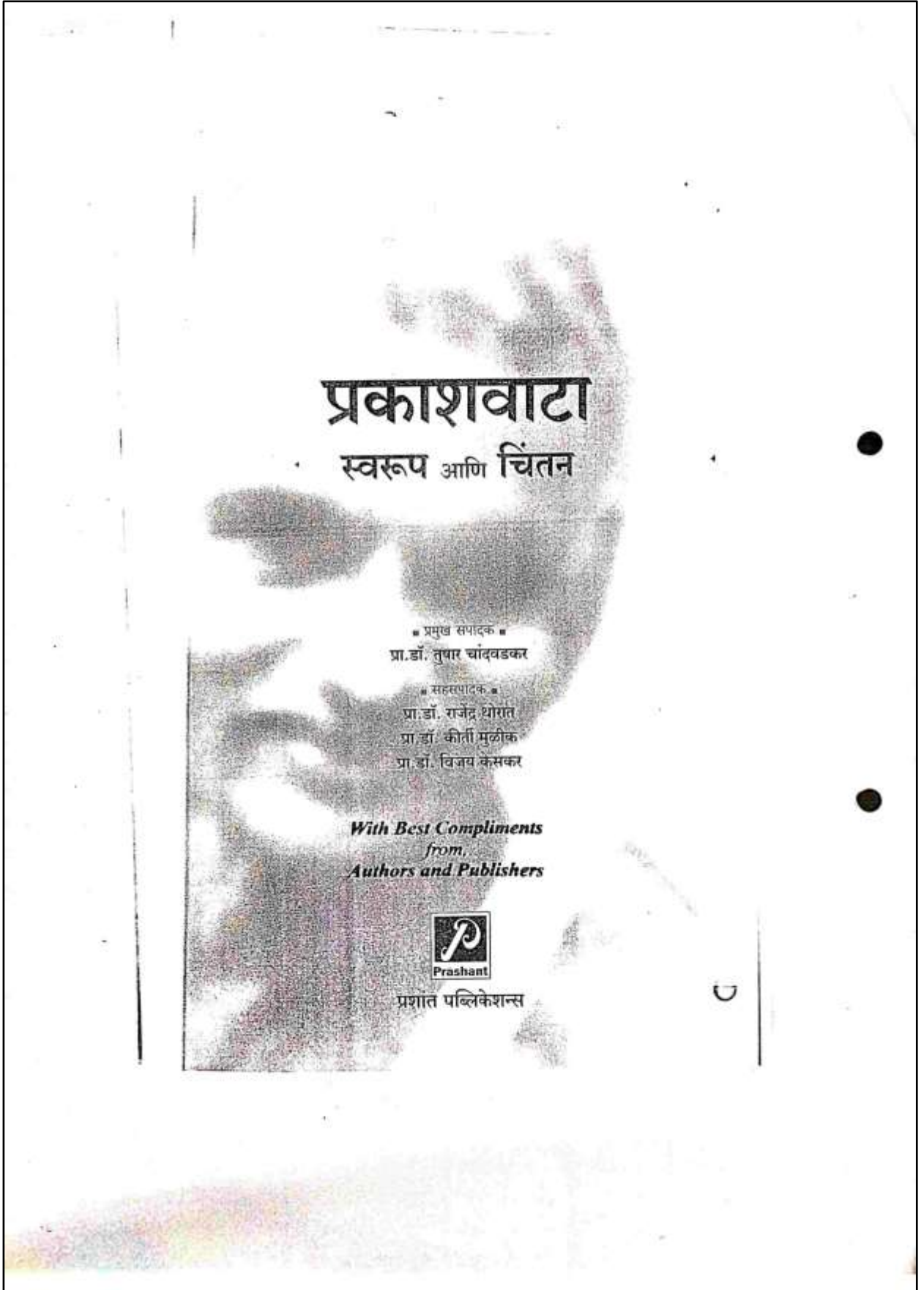



प्रकाशवाटा : स्वरूप आणि चिंतन
Prakashwata : Swarup Aani Chintan
© सुरक्षित

■ प्रकाशक । मुद्रक
रंगराव पाटील
प्रशांत पब्लिकेशन्स
३, प्रताप नगर, श्री संत ज्ञानेश्वर मंदिर रोड,
नूतन मराठा महाविद्यालयजवळ,
जळगाव ४२५००१.

■ दूरध्वनी । वेब । ईमेल
०२५७-२२३५५२०, २२३२८००
www.prashantpublications.com
prashantpublication.jal@gmail.com

■ आवृत्ती । आयएसबीएन । किंमत
ऑक्टोबर २०२०
९७८-९३-९०४८३-३७-२
₹ २५०/-

■ अक्षरनुलचणी
प्रशांत पब्लिकेशन्स

e-Books are available online at www.prashantpublications.com

Prashant Publications app for e-Books
kopykitab.com • amazon.com • play.google.com

या पुस्तकातील कोणताही मजकूर, कोणत्याही स्वरूपात वा माध्यमात पुनर्प्रकाशित अथवा संग्रहित करण्यासाठी लेखक/प्रकाशक दोघांचीही लेखी पूर्णपरवानगी घेणे बंधनकारक आहे. तसेच मजकुराची जबाबदारी ही सर्वेसर्वा लेखकाची राहिल. लेखकांनी याद्वारे सर्वांचे संगणक सहमत असतील असे नाही.

२ । प्रशांत पब्लिकेशन्स

हेमलकसा : प्रकाश आमटे यांच्या आयुष्यातील निर्णायक वळण

डॉ. हरीश संपत शेळके

मराठी विभागप्रमुख, न्यू आर्ट्स कॉमर्स अँड सायन्स कॉलेज, पारनेर. जि.अ.नगर

१) प्रास्ताविक :

दुर्दम्य इच्छाशक्ती, आत्मविश्वास, कणखरपणा, स्वतःवर विश्वास, दुसऱ्यांसाठी मनापासून राबण्याची तयारी असेल तर आपण आकाशालाही गवसणी घालू शकतो असे म्हटले जाते. या वाक्याचा प्रत्यय 'प्रकाशवाटा' हे आत्मचरित्र वाचताना क्षणोक्षणी येतो. या आत्मचरित्राचे शीर्षकच इतके समर्पक आहे की त्या शीर्षकाच्या नावातच प्रकाश आणि त्या प्रकाशातूनच नव्या वाटा तयार करण्याचे सामर्थ्य देखील आहे. जगण्यासाठी लागते बळ, लागते प्रेरणा, लागतो विश्वास. हे सर्वकाही दुधडी भरून वाहत असलेल्या नदीसारखे या आत्मचरित्रात वाहताना दिसून येते. आपण पुस्तके वाचतो आनंदासाठी, कधी कधी वेळ घालवण्यासाठी, कधी दुसऱ्याने सांगितले म्हणून परंतु प्रकाशवाटा हे आत्मचरित्र असे आहे की ते कोणत्याही उद्देशाने तुम्ही वाचायला घेतले तरी तुमचे आयुष्य बदलवून टाकल्याशिवाय राहणार नाही. तुमच्या आयुष्याला नवी वाट दाखविल्याशिवाय राहणार नाही. काय असतं माणसाचं आयुष्य, माणूस कशासाठी जगतो, आपल्या जगण्याचा नेमका अर्थ काय? आपण नेमके कोणासाठी जगतो, आपली घडपड कशासाठी आहे, आपल्या जीवनाचे उद्देश काय आहेत, अशा सर्व प्रश्नांची उत्तरे प्रकाशवाटा हे आत्मचरित्र वाचताना आपल्याला मिळत जातात.

या आत्मचरित्राचे आणखी एक विशेष म्हणजे, "आत्मचरित्रात्मक लेखनातून साकार होणाऱ्या लेखक/लेखिकेच्या व्यक्तिमत्त्वाला सामाजिक, सांस्कृतिक, मानसिक संदर्भ असतात. त्यामुळे या मूल्यांच्या संदर्भात विशिष्ट भूमिकेतून अशा लेखनाचे विश्लेषण आणि मूल्यमापन करणे शक्य असते. त्यामुळे एक संदर्भसामग्री किंवा दस्तऐवज म्हणून आत्मचरित्राला महत्त्व प्राप्त होत असते." प्रकाशवाटा हे आत्मचरित्र मानवी मूल्यांच्या प्रत्ययकारी अनुभवाचे खरोखर एक दस्तऐवज आहे. त्यामुळेच कोणत्याही वयोगटातील वाचक असो त्याला आवडणारे, प्रेरणा देणारे, उत्साह वाढवणारे असे हे आत्मचरित्र आहे. सर्वसाधारणपणे विचार केला तर १८ ते २२ या वयोगटातच विद्यार्थ्यांची उत्तम जडणघडण होत असते. या टप्प्यावर त्यांच्या वाचनात योग्य पुस्तके आली, त्यांना जीवनविषयक योग्य असा

६६ | प्रशांत पब्लिकेशन्स

दृष्टिकोन मिळाला, साहित्यविषयक त्यांची अभिरूची विकसित होत गेली तर त्यांच्या आयुष्याला खूप चांगले चळण या टप्प्यावर मिळते. एका अर्थाने त्यांचे व्यक्तिमत्त्व खूप चांगल्या पद्धतीने आकाराला येते. या सर्व गोष्टींचा विचार केला तर एस.वाय.बी.ए. या वर्गात शिक्षण घेत असणाऱ्या विद्यार्थ्यांसाठी हे आत्मचरित्र ही एक पर्वणीच आहे.

तर आता आपण पाहू हेमलकसा : प्रकाश आमटे यांच्या आयुष्यातील निर्णायक चळण कसे ठरले.

२) हेमलकशाचा प्रवास :

प्रकाश आमटे हे लग्न झाल्याच्या दुसऱ्याच दिवशी ताडोबाला गेले. तेथून ते आलापल्ली भामरागड येथे गेले. त्याच ठिकाणी त्यांनी त्या रात्री मुक्काम केला. तेथील वनअधिकार्यांची त्यांनी भेट घेतली. अधिकार्यांना ते म्हणाले आमचे नुकतेच लग्न झाले आहे. आम्ही या जंगलात चांगले काम करण्यासाठी आलो आहोत. त्यांचे हे बोलणे ऐकून त्या वनअधिकार्यांना फार कौतुक वाटले. विशेष म्हणजे प्रकाश आमटे यांच्या पत्नी मंदा यांनी हेमलकसा हे पाहिलेही नव्हते. त्यांना तेथील परिस्थितीबद्दल फारशी कल्पनाही नव्हती. मात्र आनंदवन व सोमनाथ येथील प्रकल्प त्यांनी पाहिले होते. हे दोन्ही प्रकल्प शहराच्या जवळ असल्यामुळे तिथे बऱ्याच सुधारणा झाल्या होत्या. परंतु हेमलकसा मात्र मंदा यांच्यासाठी नवीन होते. येथे कोणत्याही प्रकारची सुविधा नव्हती, रस्ते नव्हते, पिण्यासाठी पाणीही नव्हते. सगळीकडे फक्त जंगल, आधार म्हणून वरती डोक्यावर छतही नव्हते. ही सर्व परिस्थिती पाहूनही प्रकाश आमटे सांगतात मंदा शांत राहिली. तिने ही सर्व परिस्थिती समजावून घेतली. माणसातील शहाणपण आणि समजूतदारपणा एकत्र जुळून आल्यावर त्याला अभयारण्यही निसर्गाचं एक देखणं रूप आहे, असं वाटू लागतं आणि माणूस आहे ती परिस्थिती स्वीकारून तेथेही आनंदाने राहू लागतो. प्रकाश आमटे व मंदा आमटे यांच्या आयुष्यातील हेमलकशाचा प्रवास खडतर, संघर्षमय आणि प्रचंड वेदनादायी असा होता, असे म्हटले तरी वावगे ठरणार नाही.

३) हेमलकशातील सुरुवातीचे संघर्षमय दिवस :

आनंदवनापासून हेमलकसा हे अडीचशे किलोमीटरवर आहे. रस्तेही अगदीच खराब असल्यामुळे हेमलकशाला पोहचण्यासाठी तब्बल एक दिवस लागायचा. कारण वाटेत नदी, ओढेही भरपूर होते. पावसाळ्यात तर सगळीकडे पाणीच पाणी असे. अशावेळी वाटेत मुक्काम करण्याची वेळ आली तर एखादी जागा असावी म्हणून 'नागेपल्ली' येथे बाबा आमटे यांनी ही जागा मागितली होती. या दोन्हीही

प्रकाशवाटा : स्वरूप आणि चिंतन । ६७

जागांना शासनाकडून मान्यता मिळताच बाबा आमटे हे आपल्या काही निवडक कार्यकर्त्यांसह हेमलकशाला जाऊन पोहचले. २३ डिसेंबर १९७३ या दिवशी बाबा आणि त्यांच्या सहकाऱ्यांनी तेथे पहिला मुकाम केला. प्रकाश आमटे हे त्यावेळी नागपूरमध्ये पोस्टग्रॅज्युएशनचे शिक्षण घेत होते. त्यांना वाटत होते कधी आपल्याला ही जागा मिळेल. एकदाची परवानगी मिळाली असे प्रकाश आमटे यांना कळल्यानंतर त्यांनी शिक्षण सोडून हेमलकशाला जायचं ठरवलं. प्रकाश आमटे यांचा हा निर्णय बाबा आमटे यांना फार आवडला नाही. परंतु ते त्यांना फार काही बोलले नाहीत. बाबांची इच्छा होती की, सर्जरीचा अनुभव गाठीशी असायला हवा. त्यासाठी डॉ. वैद्य यांच्याकडे 'घटप्रभा' या ठिकाणी जाऊन वीस दिवस प्रकाश आमटे यांनी सर्जरीचा अनुभव घेतला. हा सर्व अनुभव बरोबर घेऊन ते मार्च १९७४ मध्ये हेमलकशाला गेले. तोपर्यंत बाबांनी प्रत्यक्ष कामाला सुरुवात केली होती.

सुरुवातीला तेथे काम सुरु करताना प्रचंड त्रास झाला. धनदाट जंगल, झाडी असल्यामुळे सूर्यप्रकाशही आतमध्ये येण्यास संधी नव्हती. सगळीकडे नीरव शांतता. तेथे फक्त प्राण्यांचे आवाज आणि दूरवरून वाहत असणाऱ्या नदीच्या पाण्याचे. साप, विंचू यांचे प्रमाण तर खूप मोठ्या प्रमाणात होते. हा भाग गाव व शहरापासून पूर्णपणे लांब, तुटलेला असा होता. त्यामुळे अतिशय प्रतिकूल परिस्थितीत तेथे कामाला सुरुवात केली. जेव्हा एखाद्या ठिकाणी नवे काम उभे करावचे असते तेव्हा तेथे राहण्याची जागा, पाण्याची व्यवस्था तरी असते. परंतु हेमलकशात मात्र पाणीही नव्हते, राहण्याची सोयही नव्हती, आजूबाजूला माणसेही नव्हती. फक्त जंगल, जंगलातील आदिवासी आणि तेथील प्राणी एवढंच अवतीभवती होते. प्रकाश आमटे हेमलकशाला पोहचण्यापूर्वी बाबा आमटे यांच्याबरोबर अजित मळकर्णेकर, नागेश हटकर, राज सुलाखे, जगन मचकले, दादा पांचाळ, विलास मनोहर, गोपाळ फडणीस, शरद कुलकर्णी, मुकुंद दीक्षित, जगदीश गोडबोले हे सर्व कार्यकर्ते तिथे पोहचले होते. एक चांगली टीम या सर्वांतून आकाराला आली होती. हेमलकशामध्ये चांगल्या पद्धतीने कामाला सुरुवात झाली होती. सुरुवातीला सर्वांचा मुक्त झाल्यालाच होता. कारण वर डोक्यावर कोणत्याही प्रकारचे छत नव्हते. परंतु झाडाखाली किती दिवस राहणार म्हणून राहण्याची सोय तर करावीच लागणार होती. म्हणून मग जंगलाच्या मध्यभागी, जागा मोकळी करून प्रकाश पेडणेकर नावाच्या कार्यकर्त्यांनी एक झोपडी बांधली. येथे सर्व काम शून्यातून उभे केले जात होते. कारण कोणतीही सुविधा उपलब्ध नसल्यामुळे सर्व गोष्टींची सुरुवात पहिल्यापासून करावी लागत होती. दुसऱ्या बाजूला खाण्यासाठी लागणारे

६८ | प्रशांत पब्लिकेशन्स

Y

अन्न, पाणी हे प्रश्नही गंभीरपणे उभे होतेच. अशा वातावरणात डोक्यावर छप्पर आल्यानंतर आम्हाला जवळच एका नाल्याजवळ खड्डा खोदून पिण्याच्या पाण्याची व्यवस्था करावी लागली. चापरण्यासाठीचे पाणी नदीवरून बैलगाडीत ड्रम भरून दोन-अडीच किलोमीटरवरून आणावे लागत असे. आंधोळ नदीवरच केली जाई.

अशा परिस्थितीत हेमलकशात प्रत्यक्ष कामाला सुरुवात झाली कारण आदिवासींना आरोग्यदायी जीवन जगायला शिकवायचं हेच घ्येय डोक्यासमोर होतं. म्हणून प्रतिकूल परिस्थितीवर मात करत सर्वजण एकजुटीनं मनापासून राब राब राबत होते.

४) हेमलकशातील अडचणींवर केलेली मात :

प्रकाश आमटे सांगतात की, हेमलकशातल्या अडचणींवर मात करत जगायला आम्ही शिकत होतो पण जगाशी आमचा काही संपर्क नव्हता. जंगलात येऊन राहत असल्याने आमच्यापर्यंत वर्तमानपत्र, पुस्तके वगैरे काही पोहचण्याचा प्रश्नच नव्हता. त्यामुळे जगात काय चालले आहे, हे येथील लोकांना बऱ्याचदा काहीच माहित नसे. त्यांच्याकडे त्यावेळी एक ट्रान्झिस्टर होता. त्यावरच हे लोक बातम्या ऐकायचे. जगापासून ते एवढे तुटले होते की, २६ जून १९७५ ला आणीबाणी जाहीर झाली, याचा हेमलकशात सुरुवातीला पत्ताच नव्हता. कारण त्यापूर्वीच १७ जूनला तेथे प्रचंड पाऊस झाल्याने सर्वांशी त्यांचा संपर्क तुटला होता. प्रकाश आमटे सांगतात हेमलकशातला सुरुवातीचा काळ आमच्यासाठी कमालीचा प्रतिकूल असा होता. कोणतीही गोष्ट साध्य करायची असेल तर संघर्ष करणे अटळ असते. उर्वरित जगाशी कोणताही संपर्क नसलेल्या भागात येऊन राहण्याचा निर्णय आमचा आम्हीच घेतलेला असल्याने त्याचं दुःख कुणाला नव्हतं, मात्र विपरीत परिस्थितीशी कपवा लागणारा झगडा हा परीक्षा घेणाराच होता. खेड्यात किंवा शहरात राहणाऱ्या कोणत्याही सामान्य माणसासारखं ते जीवन नव्हतं. आम्ही ज्या भागात आमचं नवं जीवन जेथे उभे करू पाहत होतो. तेथून बाहेर पडण्यासाठी ना रस्ते होते ना वाहनांच्या सुविधा, इतरांशी संपर्क करण्यासाठी पोस्टही नव्हते व फोनही नव्हते. आनंदवनाशी जोडणारा एकच दुवा होता तो म्हणजे नागेपल्लीच्या प्रकल्पाची जबाबदारी पार पाडणारा जगन मचकले. विशेषतः पावसाळ्यात जेव्हा संपर्क पूर्णपणे तुटायचा आणि काही महत्त्वाचा निरोप किंवा सामान पोचवायचं असेल तर आम्ही पूर्णपणे जगनवर अवलंबून असायचो. तेव्हा त्यांच्याकडे होती फक्त एक सायकल. ती सायकल दामटत तो तब्बल ६५ किलोमीटर निव्वळ निरोप घायलाही यायचा.

हेमलकशामध्ये जी महत्त्वाची औषधं व इतर आवश्यक सामान लागत असे ते

प्रकाशबाटा : स्वरूप आणि चिंतन । ६९

जगन सायकलवर पोहचवत असे. जगन हेगलकशाच्या दिशेने सायकलला पायडल मारत निघायचा. त्याला चाटेत दहा-बारा नाले आणि बांदिया नदी लागत असे. खुपदा हे नदी-नाले दुधडी भरून वाहत असत. मग एका तीरावर सायकल ठेऊन जगन हे सगळं सामान डोक्यावर घेऊन पाण्यातून पलीकडच्या तीरावर नेत असे. साहित्य जर जास्त असेल तर त्याला अशा दोन-तीन फेऱ्या कराव्या लागत असत. सामानाच्या ओझ्याने जड झालेली सायकल ओढ असलेल्या पाण्यातून नेणं कठीण असे म्हणून त्याला हा सारा खटाटोप करावा लागत असे. ओढा ओलांडला की, सायकलची पुढची रपेट त्याला सुरू करावी लागत असे. एखाद्या ठिकाणी पाणी जास्त असेल तर तो उतरायची वाट घटत जंगलात तासन्तास थांबून राहायचा. हे वर्षानुवर्षे तो करत आला अगदी हसतमुखाने.

माडिया गोंड आदिवासी फारसे कपडे वापरत नसत. कमरेला बांधलेल एक फडकं, एवढाच त्यांचा पोशाख. लहान मूलं तर तेवढेही कपडे घालायचे नाहीत. कितीही थंडी असो, पाऊस असो, माडिया गोंड लोकांचा वेप ठरलेलाच. हे सर्व पाहिल्यावर प्रकाश आमटे म्हणतात आम्हीही अर्धा पांढरी पैंट आणि कोपरीसारखा अर्ध्या बाह्यांचा बनियन असे कपडे घालायला सुरुवात केली. एका अर्थाने समोर येईल तशा परिस्थितीला, जीवनशैलीला सामोरे जाऊन प्रकाश आमटे व त्यांच्या सहकाऱ्यांनी स्वतःमध्ये बदल केलेला आपणाला दिसून येतो. एका अर्थाने असे म्हणता येईल की अडचणीनाच संधी मानून त्याचे सोने करण्याचे काम प्रकाश आमटे व त्यांच्या सहकाऱ्यांनी केलेले दिसून येते. माडिया भाषेत उच्चार करण्याची विशिष्ट पद्धत, हाच त्या भाषेचा बेस आहे. ही भाषा मराठी भाषेहून वेगळी 'तापा'ला या भाषेत 'दंड' म्हणतात. यांचे म्हणजे पाणी येथील वनखात्याच्या माणसांना ही भाषा माहित होती. त्यामुळे माडिया शब्द आणि त्याचे अर्थ प्रकाश आमटे व त्यांचे सहकारी त्यांच्याकडून लिहून घेऊन शिकले. भाषा शिकण्यासाठी त्यांनी पेशंटचीच मदत घेतली. कधी कधी गावात जाऊन तेथील लोकांशी संवाद साधण्याचा प्रयत्न सुरू केला. अशा प्रकारे गरजेपुरती माडिया भाषा आम्हाला समजायला लागली, असे प्रकाश आमटे म्हणतात.

माडिया लोकांना मराठी भाषा येत नसल्यामुळे आणि समजतही नसल्यामुळे प्रकाश आमटे यांना त्यांना औषध कशी घ्यायची हे सांगणे मोठे कठीण झाले. कारण ते लोक रॅपरसकट गोळ्या खायचे. त्यांना औषधाचं प्रमाणही कळत नसे. कधी कधी सर्व औषध एकदम घेतले तर लवकर बरे चाटेल, अशा समजूतीने ते सर्व औषध, गोळ्या एकदम खायचे. असे दोन-तीन प्रकार घडले. अशा वेळी त्यांना उलटी करावला लावून ते जास्तीचं औषध त्यांच्या पोटातून बाहेर काढले

जाई. अशा वेळी त्यांना समजावताना खूप त्रास व्हायचा.

अशा प्रकारे हेमलकशातील अडचणींवर प्रकाश आमटे व त्यांच्या सहकाऱ्यांनी मात केलेली दिसून येते.

५) आदिवासींच्या नव्या आयुष्याला सुरुवात :

माडिया गोंड ही आदिवासी जमात खूपच मागासलेली आहे. त्यांना लिहिता-वाचता येत नाही, कपडे घालायची त्यांना सवय नाही, दुसरी भाषा त्यांना येत नाही, कमालीचं अज्ञान त्यांच्यामध्ये असलेले दिसून येते. गरीबीमुळे दोन वेळच्या जेवणाचीही सोय नाही, अफाट दारिद्र्य त्यांच्या वाटचाला आलेले दिसून येत, लहान मुलांपासून ते म्हातान्यांपर्यंत सगळे अन्न मिळविण्याच्या धडपडीत असलेले दिसून येतात, कुपोषणाचे प्रमाणही प्रचंड जास्त, गरिबीमुळे शिक्षण, घ्यायला वेळ नाही, अंधश्रद्धा मोठ्या प्रमाणावर इत्यादी अशा अनेक समस्या आदिवासींच्या जीवनात असलेल्या दिसून येतात. या सर्व समस्या माहित असतानाही हेमलकशामध्ये बाबांनी या आदिवासींच्या आयुष्यात नवी पहाट उगवण्यासाठी काम सुरू केले होते. प्रत्यक्ष हेमलकशात ज्या दिवसापासून काम सुरू झाले तेव्हापासून आदिवासींच्या नव्या आयुष्याला सुरुवात झालेली आपल्याला पाहायला मिळते.

सुरुवातीला प्रकाश आमटे व त्यांच्या सहकाऱ्यांना आदिवासींची भाषा समजून घेण्यासाठी खूप प्रयत्न करावा लागला. नंतर भाषा हळूहळू अवगत केल्यानंतरही आदिवासी प्रत्यक्ष सुरू केलेल्या दवाखान्यात उपचार घेण्यासाठी येत नसत. कारण त्यांच्यामध्ये अंधश्रद्धा मोठ्या प्रमाणात होती. उपचारासाठी मांत्रिकाकडेच जायचे, असा त्यांचा रिवाज होता. हळूहळू यामध्ये फरक पडत गेला. आदिवासी लोक दवाखान्यात येण्यास सुरुवात झाली. त्यांच्यावर केलेल्या उपचारामुळे ते लवकर बरे होऊ लागले. त्यामुळे त्यांच्यात आनंदाचे वातावरण निर्माण झाले. आपण गोळ्या, औषधाने लवकर बरे होतो, यावर त्यांचा विश्वास बसू लागला. त्यातूनच मग त्यांच्यातील अंधश्रद्धेचे प्रमाण कमी होऊ लागले, दैनंदिन जीवनात त्यांच्या राहणीमानात बदल झाले, हळूहळू ते संवाद करू लागले. एका अर्थाने त्यांच्यातील जीवनशैलीला एक नवे स्वरूप प्राप्त झाले. त्यांच्या आयुष्याला नवी दिशाच मिळाली.

६) हेमलकशाला कुटुंबाच रूप येत तेव्हा :

सुरुवातीला बाबा आमटे यांनी त्यांच्यासोबत काही मोजक्या कार्यकर्त्यांना बरोबर घेऊन हेमलकशामध्ये अतिशय प्रतिकूल परिस्थितीत काम सुरू केले होते. त्यानंतर प्रकाश आमटे यांनीही काम सुरू केले. नंतर आनंदवनातून हळूहळू काही लोक येत गेले आणि हेमलकशातील कामाने जोर धरला. पाहता पाहता

प्रकाशवाटा : स्वरूप आणि चिंतन । ७९

हेमलकशाला एका मोठ्या कुटुंबाचे स्वरूप प्राप्त झाले. या कुटुंबात बाबा आमटे यांच्यासोबत आलेले कार्यकर्ते, प्रकाश आमटे, मंदा आमटे, त्यांच्यासोबत आलेले सहकारी, आदिवासी, जंगलातील प्राणी अशा विशाल स्वरूपाचे एक कुटुंब हेमलकशात आकाराला आले.

आपण पाहतो समाज जीवनात वावरताना अनेक माणसं ध्येयवादीवृत्तीने समाज परिवर्तनासाठी स्वतःला झोकून देऊन काम करतात. त्यांच्या व्यक्तिगत जीवनात खूपदा त्यांना अनेक हालअपेष्टांना तोंड द्यावे लागते. परंतु या सर्व गोष्टींकडे ते सहजपणे दुर्लक्ष करतात आणि ज्या कामामध्ये त्यांनी स्वतःला झोकून दिले आहे ते कामच त्यांच्या आयुष्याचा भाग बनते. ते काम, तेथील माणसे, तेथील व्यवस्था, मुल्ये अशा सर्व गोष्टी-त्यांच्या जीवनाचा भाग बनतात. त्यातूनच एक विशाल असे कुटुंब आकाराला येते. या कुटुंबातील प्रत्येकजण स्वतःबरोबर इतरांचे आयुष्य घडविण्यासाठी घडपडत असतो. या घडपडीतूनच पुढे हजारो माणसांचे आयुष्य घडत जाते आणि त्यातूनच विशाल अशा स्वरूपाचे समाजपरिवर्तन झालेले आपल्याला दिसून येते. बाबा आमटे यांनी जे छोटेसे रोप समाजसेवेच्या वृत्ताचे लावले होते ते पुढे प्रकाश आमटे, मंदा आमटे, विकास आमटे त्यांच्या कुटुंबातील सर्व सहकारी, त्यांच्या सोबतीला असणारे सर्व कार्यकर्ते, आदिवासी लोक अशी असंख्य माणसे या समाजसेवेच्या वृत्ताला जोडली गेली आणि पुढे विशाल अशा वटवृक्षात या कामाचे रूपांतर झालेले आपल्याला पाहायला मिळते. आजही आनंदवन, सोमनाथ, हेमलकसा या सर्व ठिकाणी हे समाजसेवेचे कार्य आजही अहोरात्र सुरू आहे. बाबा आमटे यांनी 'महारोगी सेवा समिती'ची १९४९ साली स्थापना केली. अगदी तेव्हापासून ते आजतागायत हे काम सुरू आहे. या विशाल कालखंडाच्या पटावरूनच आपल्या लक्षात येईल की, बाबांनी सुरू केलेले हे काम, त्याचे स्वरूप आज किती मोठ्या कुटुंबाचे भाग बनलं आहे.

हेमलकशामध्ये काम करत असताना प्रकाश आमटे सांगतात की, आपल्यासमोर उभ्या ठाकणाऱ्या प्रश्नांना आपणच तोंड द्यायचं आहे, हे लक्षात येऊन आम्ही त्यातून वाट काढायला शिकलो. दुसरं म्हणजे सततच्या सहवासाने, अडचणी एकत्र सोडवण्याने आम्ही सगळे खूप जवळ आलो. आमचं सगळ्यांचं असं एक कुटुंब तयार झाले जे अजूनही एकत्र आहे.

७) अखेर हेमलकशानं स्वीकारलं :

प्रकाश आमटे सांगतात की, १९७५चा पावसाळा संपल्यावर बाबा नेहमीसारखे प्रकल्पावर आले. त्यांच्याबरोबर दोन परदेशी माणसं होती ते 'स्विस एड'चे कार्यकर्ते होते. या 'स्विस एड' संस्थेने आनंदवनाला पंधरा वर्षे मदत केली

७२ | प्रशांत पब्लिकेशन्स

होती. दरवर्षी येऊन ते कामाची पाहणी करत असत. हेमलकशाचा संपूर्ण प्रकल्प त्यांना दाखविला. तेथील कुपोषण, पिण्याच्या पाण्याचा प्रभाव या सर्व गोष्टी त्यांच्या लक्षात आल्या. तिथे नाल्याच्या बाजूच्या खड्ड्यातून किंवा नदीवरून बैलगाडीत ड्रम टाकून पाणी आणावे लागे, तेथे सर्व जण झोपड्यांत राहायचे, मांडय टाकलेले असत. त्यात पेशंट राहायचे, त्यांच्यावर उघड्यावरच उपचार केले जात असत. हे सर्व त्यांनी पाहिल्यावर त्यांना आश्चर्य घाटले. त्यांनी घर, दवाखाना, बोअरवेल यासाठी खूप मोठी मदत केली. 'स्विस एड'ची मदत सुरू झाल्यावर पकी घरं बांधली गेली. बाबांच्या इच्छेप्रमाणे आमची घर तयार झाली. तेथे राहण्यासही सुरुवात झाली. पावसाळ्यात उपचार करायला, गंभीर आजारी रुग्णांना राहायला दवाखानाही तयार झाला. अशा प्रकारे हेमलकशाचं रूप हळूहळू बदलायला लागलं. प्रकाश आमटे म्हणतात, हे सर्व बदलण्यास सुरुवात झाल्यावर दवाखान्यात पेशंटची गर्दीही वाढायला लागली, मदतीचे हातही पुढे सरसावले, कुटुंबातील माणसंही वाढायला लागली आणि खात्री पटली की हेमलकशानं आता आपल्याला स्वीकारलं आहे.

सारांश :

एखादे रोप लावलेले असेल आणि त्याची काळजी घेण्यास सांगितली, त्याचे संगोपन करायला सांगितले तर ते फारसे अवघड नसते. परंतु नव्याने एखादे रोप लावायचे असेल, त्यासाठी खड्डा तयार करण्यापासून सर्व काही करायचे असेल तर मात्र शुन्यातून सुरुवात करावी लागते. कारण रोप लावण्यापासून ते त्याची वाढ करण्यापर्यंतची सर्व जबाबदारी स्वीकारणे एवढे सोपे नसते. प्रकाश आमटे यांनी हेमलकशाचे काम असे शुन्यातून सुरू केलेले आपणाला दिसून येते. एखाद्या कामाला सुरुवात केल्यानंतर अगदी झपाटून जाऊन त्या कामाचा ध्यास घेत ते पूर्णत्वास नेणे एवढे सोपे नसते. हेमलकशामध्ये काम करणे हेच मुळात मोठे आव्हान होते. प्रचंड हातअपेष्टा सहन करत, प्रतिकूल परिस्थितीला सातत्याने तोंड देत, निसर्गाची अनेक आव्हाने पेलत काम करणे म्हणजे खरे तर तारेवरची कसरत असते. परंतु प्रकाश आमटे यांनी संकटांनाच संधी मानून दुर्दम्य इच्छाशक्तीच्या जोरावर सहकाऱ्यांना बरोबर घेऊन हेमलकशात परिवर्तन घडवून कसे आणले, हे 'प्रकाशवाटा' आत्मचरित्र वाचताना आपल्या प्रत्ययाला येते. आत्मचरित्र वाचताना बऱ्याचदा आपल्याला या आत्मचरित्रातील नायकाचा संघर्ष पाहायला मिळतो, त्या नायकाच्या जीवन प्रवासाची ओळख होते परंतु खूप कमी वेळा नायकाच्या संघर्षाबरोबर, इतरांच्या संघर्षाची ओळख, परिस्थितीबद्दल इतकी सखोल ओळख आपल्याला होत नाही. 'प्रकाशवाटा' हे आत्मचरित्र मात्र याला अपवाद आहे.

प्रकाशवाटा : स्वरूप आणि चिंतन । ७३

कारण हे आत्मचरित्र वाचताना यामध्ये प्रकाश आमटे यांचा संघर्षमय प्रवास त्यांच्या सहकाऱ्यांचा संघर्षमय प्रवास, हेमलकशातील प्रतिकूल परिस्थितींय केलेला संघर्ष, निसर्गाची वणनि, आदिवासी लोक, त्यांची भाषा, संस्कृत जीवन जगण्याची रीत अशा सर्व घटकांचे अतिशय वास्तवदर्शी आणि हृदयस्पर्श असे चित्रण या आत्मचरित्रात आलेले आहे. हे आत्मचरित्र वाचताना आप विचारप्रवृत्त होती, चिंतनशील होत जातो, आपला आयुष्याकडे, समाजाकडे बघण्याचा दृष्टिकोनच बदलतो, एक प्रकारे आपल्या विचारांना दिशा दाखवणारे नवी वाट दाखवणारे असे हे आत्मचरित्र आहे. जर आपल्याला प्रकाशाच्या नव्या वाटा शोधायच्या असतील तर आपण 'प्रकाशवाटा' चाचायलाच हवे.

संदर्भ ग्रंथसूची

१. आमटे प्रकाश, प्रकाशवाटा, समकालीन प्रकाशन, पुणे, प्रथमावृत्ती ७ एप्रिल २००९ एकोणिसावी आवृत्ती २ ऑक्टो. २०११.
२. राजाप्यस विजया (संपा.) व इतर, मराठी वाङ्मयकोश, खंड चौथा, महाराष्ट्र राज साहित्य आणि संस्कृती मंडळ, मुंबई, प्रथमावृत्ती नोव्हेंबर २००२.

24. Aadunik Bharatiy Bhasha : Marathi

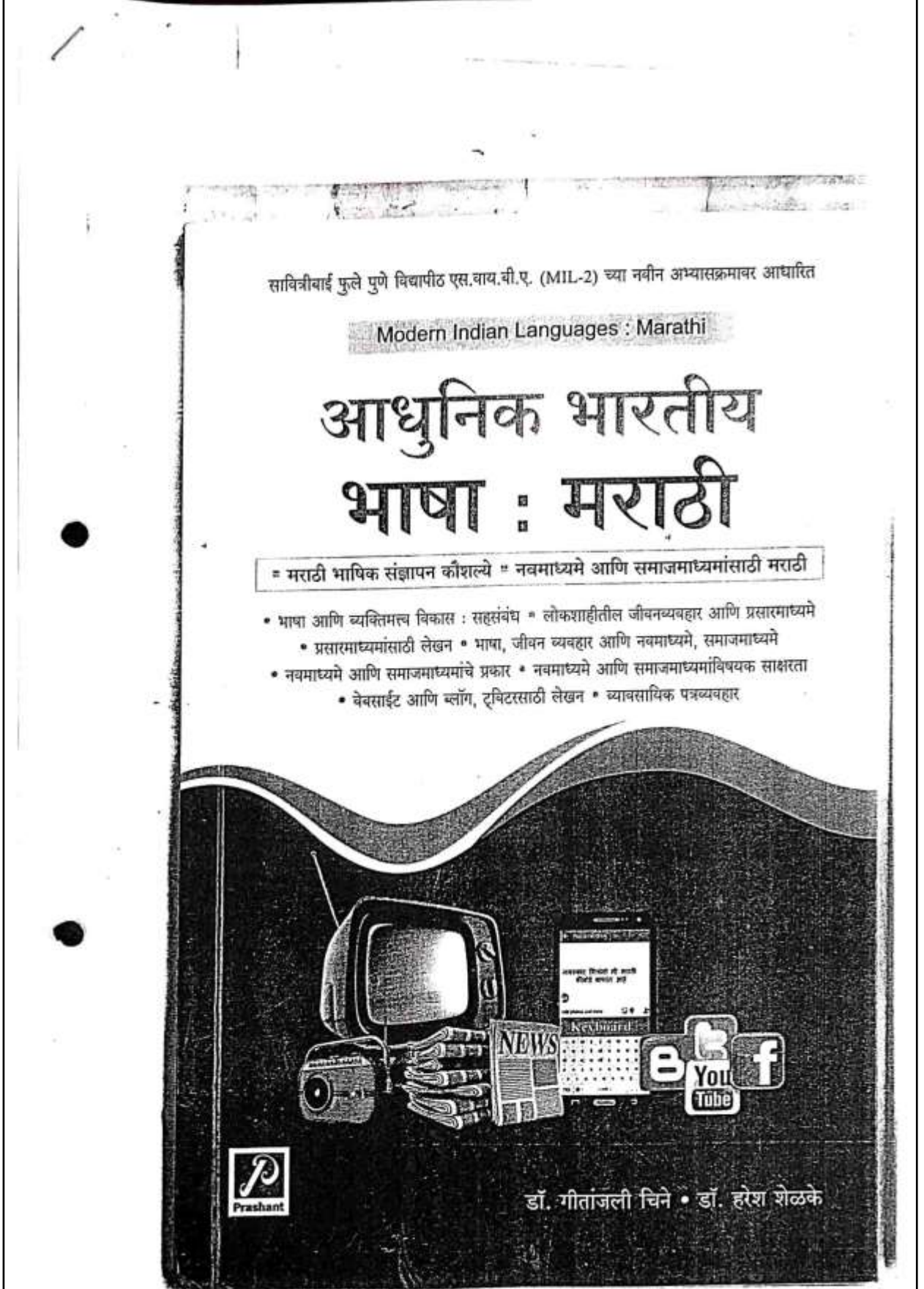



आधुनिक भारतीय भाषा : मराठी (MIL-2)
Adhunik Bhartiya Bhasha : Marathi

© सुरक्षित

■ प्रकाशक । मुद्रक

रंगराव पाटील
प्रशांत पब्लिकेशन्स
३, प्रताप नगर, श्री संत ज्ञानेश्वर मंदिर रोड,
नूतन मराठा महाविद्यालयाजवळ,
जळगाव ४२५००१.

■ दूरध्वनी । चेंब । ईमेल

०२५७-२२३५५२०, २२३२८००
www.prashantpublications.com
prashantpublication.jal@gmail.com

■ आवृत्ती । आयएसबीएन । किंमत

डिसेंबर २०२०
९७८-९३-९०४८३-७६-१
₹ १५०/-

■ अक्षरजुळवणी

प्रशांत पब्लिकेशन्स

| e-Books are available online at www.prashantpublications.com |

Prashant Publications app for e-Books
kopykitab.com • amazon.com • play.google.com

या पुस्तकातील कोणताही मजकूर, कोणत्याही स्वरूपात वा माध्यमात पुनर्प्रकाशित अथवा संग्रहित करण्यासाठी लेखक/प्रकाशक दोघांचीही लेखी पूर्वपरवानगी घेणे बंधनकारक आहे.

२ । प्रशांत पब्लिकेशन्स

25. Bhashik Kaushyal Vikas Ani Akankika

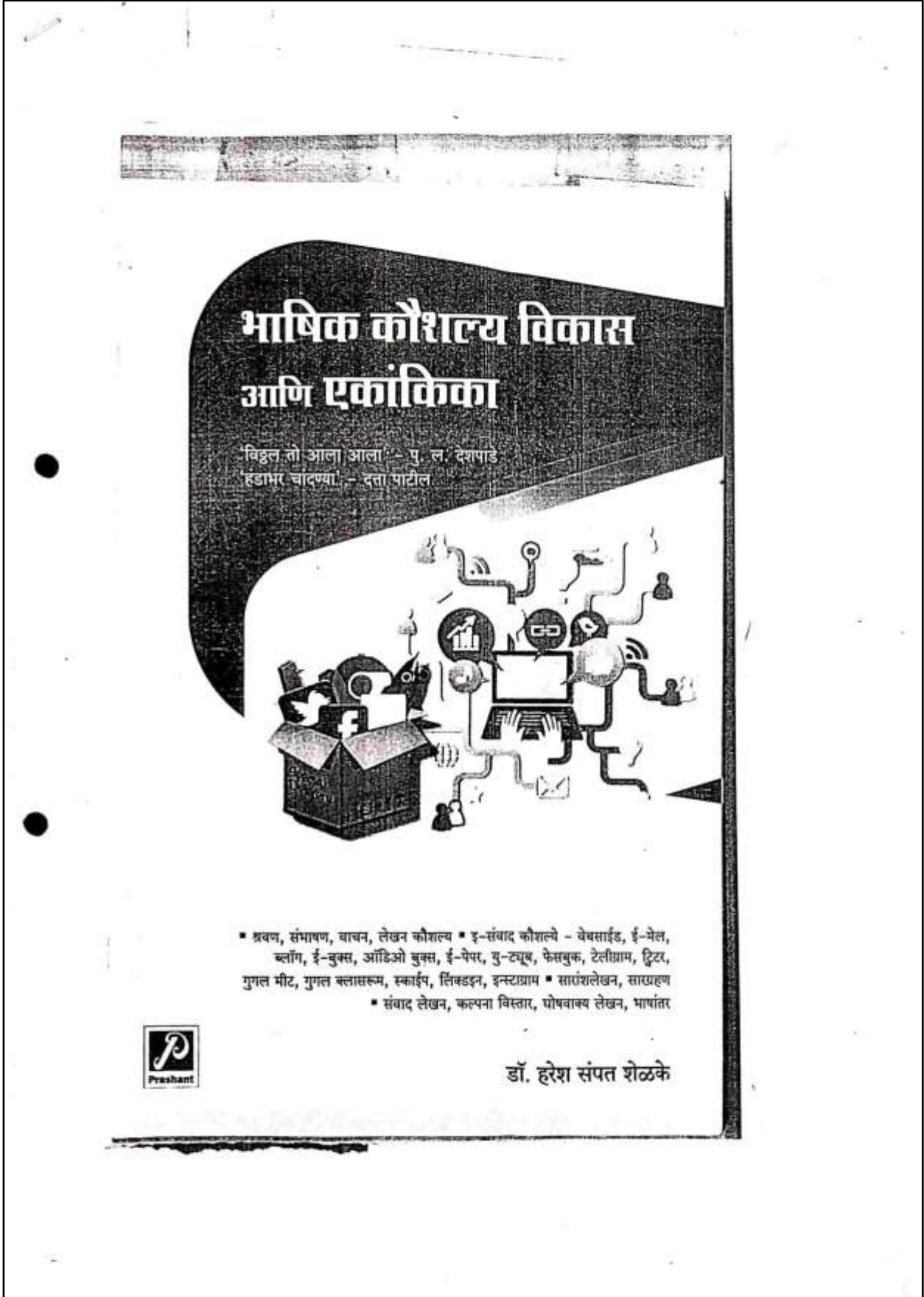



भाषिक कौशल्य विकास आणि एकांकिका
Bhashik Kaushalya Vikas Aani Ekankika
© सुरक्षित

- प्रकाशक । मुद्रक
रंगराव पाटील
प्रशांत पब्लिकेशन्स
3, प्रताप नगर, श्री संत ज्ञानेश्वर मंदिर रोड,
नूतन मराठा महाविद्यालयानजवळ,
जळगाव 425001.
- दूरध्वनी । वेब । ईमेल
0257-2235520, 2232800
www.prashantpublications.com
prashantpublication.jal@gmail.com
- आवृत्ती । आयएसबीएन । किंमत
ऑक्टोबर 2020
978-93-89493-49-8
₹ 165/-
- अक्षरजुळघणी
प्रशांत पब्लिकेशन्स

e-Books are available online at www.prashantpublications.com

Prashant Publications app for e-Books
kopykitab.com • amazon.com • play.google.com

या पुस्तकातील कोणताही मजकूर, कोणत्याही स्वरूपात वा माध्यमात पुनर्प्रकाशित अथवा संग्रहित करण्यासाठी लेखक/प्रकाशक दोघांचीही लेखी पूर्वपरवानगी पणे बंधनकारक आहे.

२ । प्रशांत पब्लिकेशन्स

26. Aadunik SahityaPrakar Kandanbari Rarang Dhang

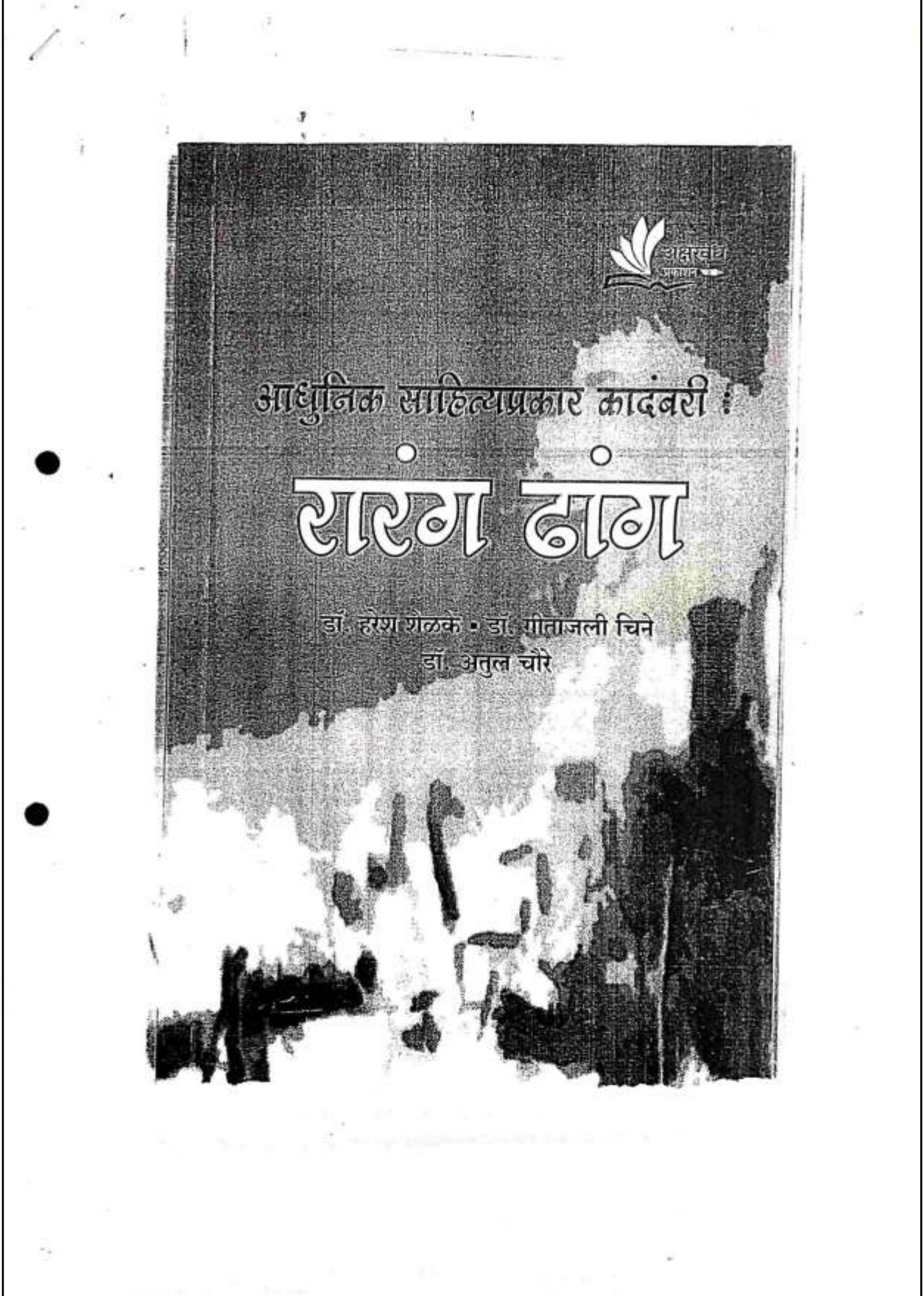



आधुनिक साहित्यप्रकार फार्मबरी : रारंग डांग
© सुरक्षित

• प्रकाशक •
अक्षरवेध प्रकाशन
502, लक्ष्मीनारायण टॉवर्स, निलायम टॉकीजजवळ, पर्यती, सदाशिव पेठ, पुणे.

• प्रमुख वितरक •
प्रशांत बुक हाऊस
3, प्रताप नगर, श्री संत ज्ञानेश्वर मंदिर रोड,
नूतन मराठा महाविद्यालयजवळ, जळगाव 425001.
फोन : 0257-2235520, 2232800 मो. 9421636460

• अक्षरजुळवणी •
अक्षरवेध प्रकाशन, पुणे
आवृत्ती : सप्टेंबर 2020
आयएसबीएन : 978-93-89493-34-4
किंमत : ₹ 175/-

e-Books are available online at kopykitab.com

या पुस्तकातील कोणताही मजकूर, कोणत्याही स्वरूपात वा माध्यमात पुनर्प्रकाशित अथवा संग्रहित करण्यासाठी लेखक/प्रकाशक दोघांचीही लेखी पूर्वपरवानगी घेणे बंधनकारक आहे.

अक्षरवेध प्रकाशन
502, लक्ष्मीनारायण टॉवर्स, निलायम टॉकीजजवळ, पर्यती, सदाशिव पेठ, पुणे.
फोन : 0257-2235520, 2232800 मो. 9421636460

27. Bhashik Kaushyal Vikas

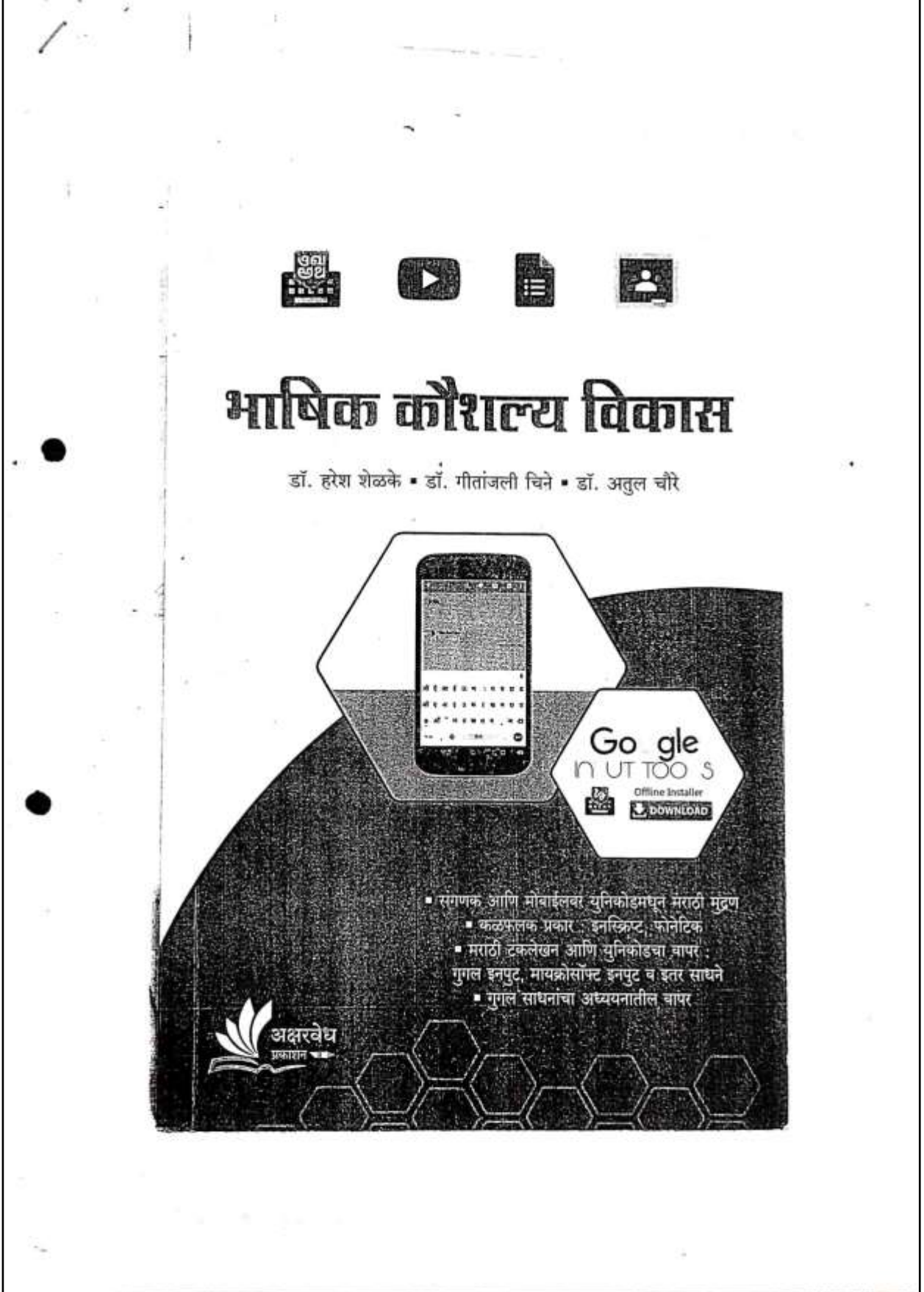



भाषिक कौशल्य विकास
 • Bhashik Kaushalya Vikas
 © सुरक्षित

◦ प्रकाशक ◦

अक्षरवेध प्रकाशन

502, लक्ष्मीनारायण टॉवर्स, निलायम टॉकीजजवळ, पर्वती, सदाशिव पेठ, पुणे.

◦ प्रमुख वितरक ◦

प्रशांत बुक हाऊस

3, प्रताप नगर, श्री संत ज्ञानेश्वर मंदिर रोड,

नूतन मराठा महाविद्यालयाजवळ, जळगाव 425001.

फोन : 0257-2235520, 2232800 मो. 9421636460

◦ अक्षरजुळवणी ◦

अक्षरवेध प्रकाशन, पुणे

आवृत्ती : सप्टेंबर 2020

आयएसबीएन : 978-93-89493-35-1

किंमत : ₹ 125/-

e-Books are available online at kopykitab.com

या पुस्तकातील कोणताही मजकूर, कोणत्याही स्वरूपात वा माध्यमात पुनर्प्रकाशित अथवा संग्रहित करण्यासाठी लेखक/प्रकाशक दोघांचीही लेखी पूर्वपरवानगी घेणे बंधनकारक आहे.

अक्षरवेध प्रकाशन

अक्षरवेध प्रकाशन

Scanned by CamScanner

28. Marathi Sahitya : Katha Ani Bhashik Kaushyal Vikas Ani Akankika Ani Bhashik Kaushyavikas

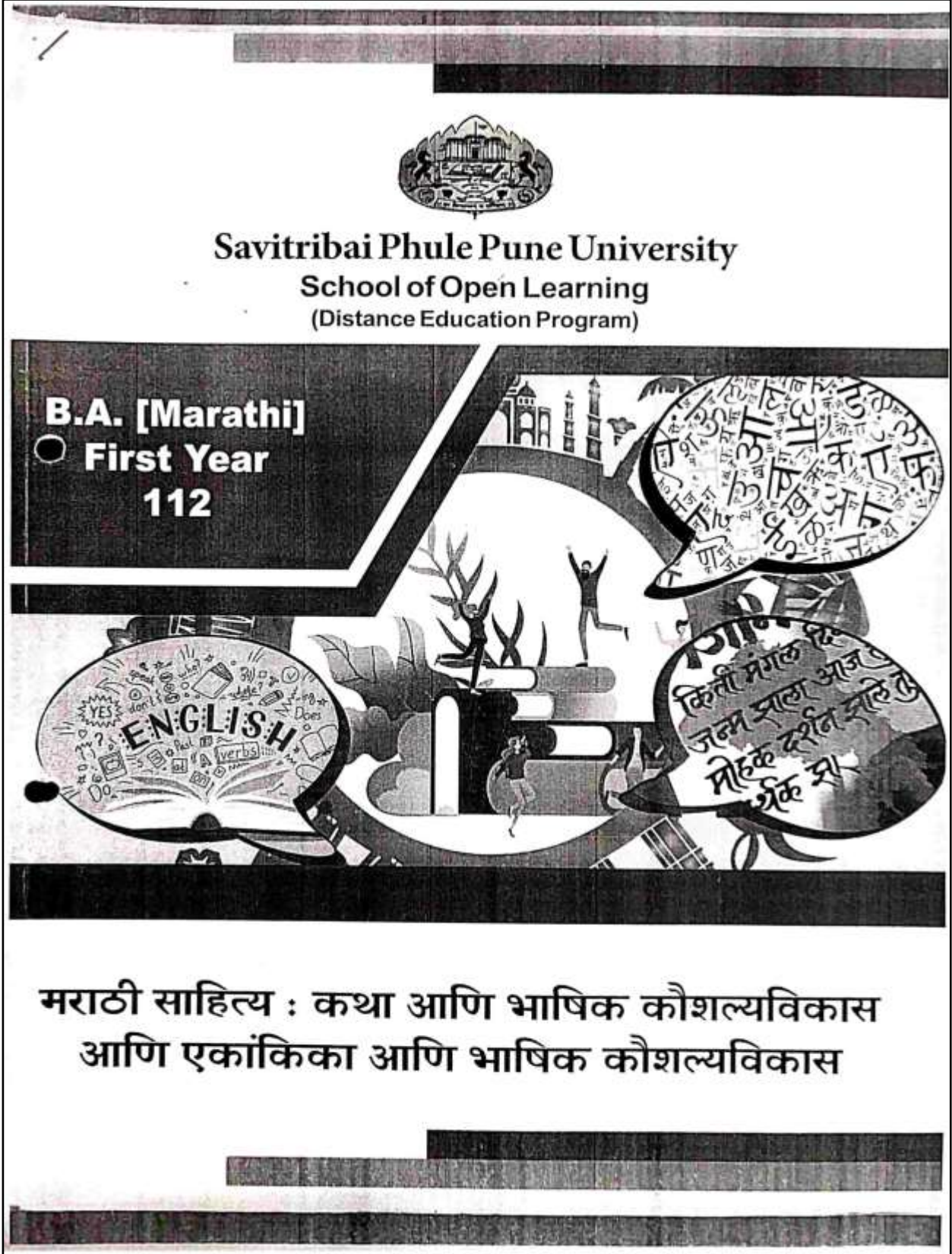

मराठी साहित्य : कथा आणि भाषिक कौशल्यविकास
आणि एकांकिका आणि भाषिक कौशल्यविकास

B.A. (Marathi)

First Year

112



SAVITRIBAI PHULE PUNE UNIVERSITY
School of Open Learning
(Distance Education Program)

लेखक

डॉ. हरेश संपत शेळके

साहाय्यक प्राध्यापक व मराठी विभागप्रमुख

न्यू आर्ट्स, कॉमर्स अँड सायन्स कॉलेज,

ता. पारनेर, जि. अहमदनगर - ४१४३०२

ई मेल - hareshelke@gmail.com

भ्रमणध्वनी - ९७६७९७६६५१

All rights reserved. No part of this publication which is material protected by this copyright notice may be reproduced or transmitted or utilized or stored in any form or by any means now known or hereinafter invented, electronic, digital or mechanical, including photocopying, scanning, recording or by any information storage or retrieval system, without prior written permission from the Publisher.

Information contained in this book has been published for School of Open Learning, Savitribai Phule Pune University, Pune by VIKAS Publishing House Pvt. Ltd. and has been obtained by its Authors from sources believed to be reliable and are correct to the best of their knowledge. However, the Publisher and its Authors shall in no event be liable for any errors, omissions or damages arising out of this information and specifically disclaim any implied warranties or merchantability or fitness for any particular use.



Vikas® is the registered trademark of Vikas® Publishing House Pvt. Ltd.

VIKAS® PUBLISHING HOUSE PVT. LTD.

E-28, Sector-8, Noida - 201301 (UP)

Phone: 0120-4078900 • Fax: 0120-4078999

Regd. Office: A-27, 2nd Floor, Mohan Co-operative Industrial Estate, New Delhi 1100 44

• Website: www.vikaspublishing.com • Email: help@vikaspublishing.com

29. महाराजा सयाजीराव गायकवाड पत्र संग्रह भाग3-

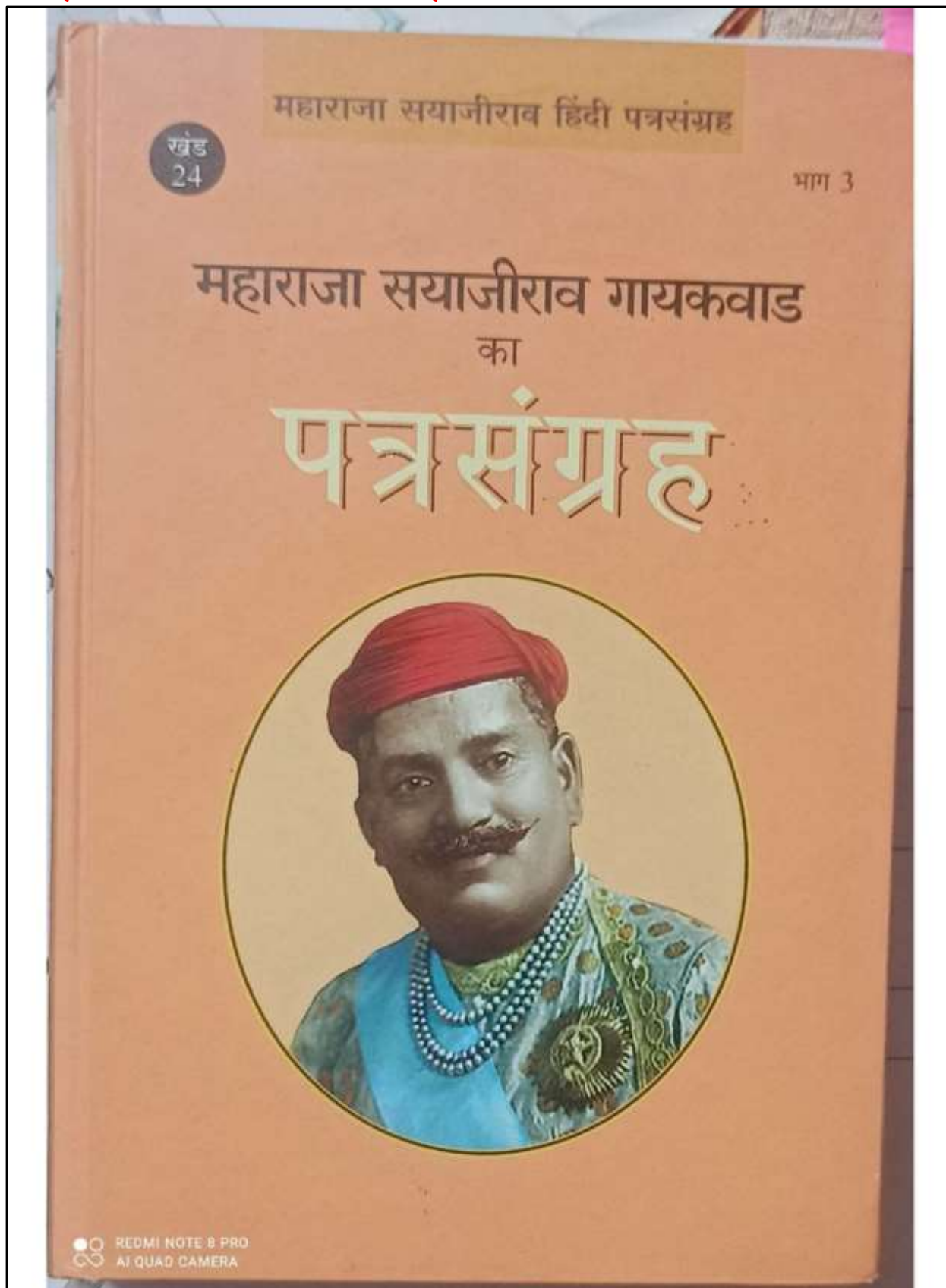

महाराजा सयाजीराव गायकवाड

पत्र संग्रह : भाग 3

संपादक

डॉ. एकनाथ पगार

अनुवादक

श्री. सोमनाथ वांजस्वाडे

डॉ. विजयकुमार राजत

प्रथम संस्करण : 2020

प्रतियों की संख्या : 5000

प्रकाशक :

सचिव,

महाराजा सयाजीराव गायकवाड

चरित्र साधन समिति, 115, म. गांधीनगर,

औरंगाबाद - 431 005.

sayajirao.govt@gmail.com

©

सचिव,

उच्च व तंत्र शिक्षा विभाग,

महाराष्ट्र शासन, मंत्रालय,

मुंबई - 400 032.

मुखपृष्ठ : राजेश दुबे / महेश मोघे

छपाई सहायता : महाराष्ट्र राज्य पाठ्यपुस्तक निर्मिति

और पाठ्यक्रम अनुसंधान मंडल, पुणे 4.

मुद्रक : प्रिंटवेल इंटरनेशनल प्रा.लि.

जी - 12, एम. आय. डी. सी.,

चिकलठाणा, औरंगाबाद, महाराष्ट्र.

Maharaja Sayajirao Gaekwad

Selected Letters : Vol. 3

Edited by

Dr. Eknath Pagar,

Original English Letters Translated
into Marathi & Hindi

For Maharaja Sayajirao Gaekwad

Source Material Publication

Committee, Higher Education,

Govt. of Maharashtra,

Mumbai - 32

प्रस्तुत प्रकाशन का हेतु महाराजा सयाजीराव
गायकवाड और उनसे संबंधित विविध विषयों
के लेखन को संयुक्त रूप से प्रकाशित करना है।

Books available at :

- The Directorate of Government Printing, Stationary and Publications, Maharashtra State, Netaji Subhash Road, Mumbai - 400 004.
Phone - (022) 23632693, 23630695, 23631148, 23634049.
- Pune : Phone - (020) 26125808, 26124759, 26128920.
- Nagpur : Phone - (0712) 2562615, 2562815, 2564946.
- Aurangabad : Phone - (0240) 2331468, 2343396, 2344653.
- Kolhapur : Phone - (0231) 2650402, 2650395, 2658625.

30. Environmental Geography

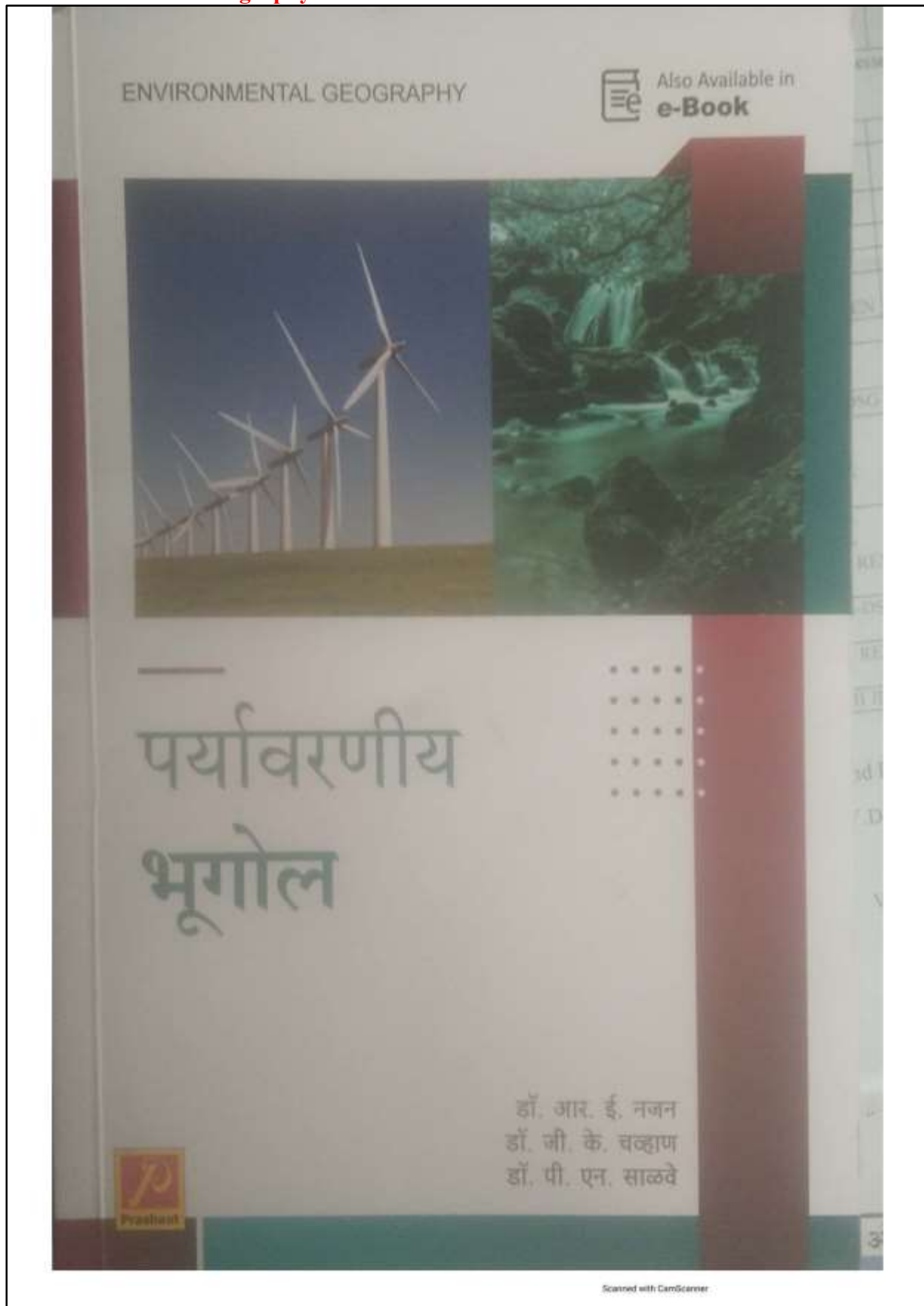



31. Economic Geography

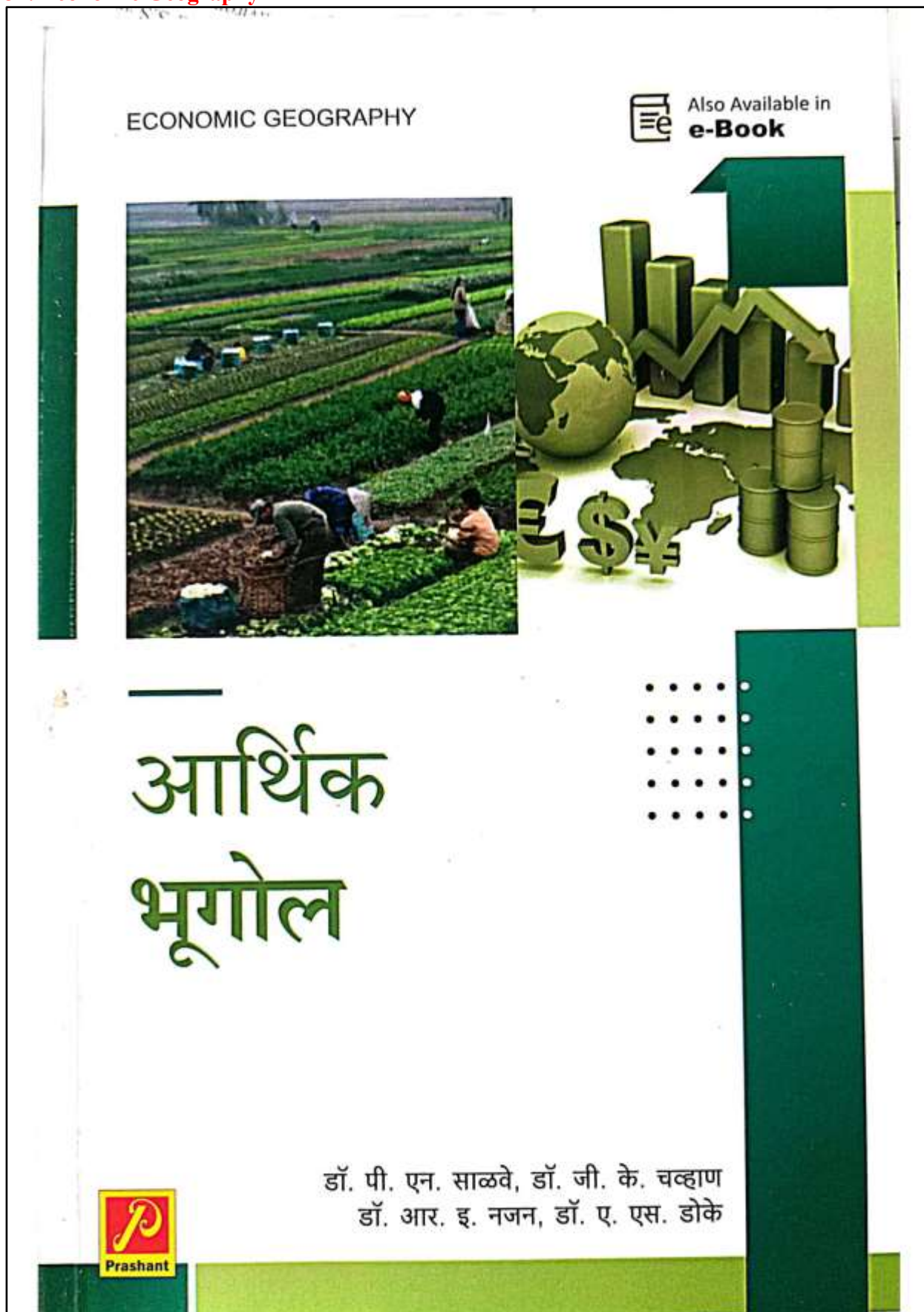

मानवाच्या आर्थिक क्रिया आणि मानवाच्या सभोवतालची परिस्थिती यांचा सविस्तर अभ्यास आर्थिक भूगोल या शाखेमध्ये केला जातो. मानव हा घटक पर्यावरणाची निर्मिती तर संसाधने ही पर्यावरणाची वैशिष्ट्ये आहेत. अर्थशास्त्रातील उत्पादन, उपभोग, विनिमय आणि वितरण या घटकांवर प्राकृतिक पर्यावरणाचा सतत परिणाम होत असतो. वस्तू उत्पादन, वस्तूंचा उपभोग आणि त्या निर्मित वस्तूंचा विनिमय याबरोबरच आर्थिक-सामाजिक आणि बौद्धिक गरजांच्या पूर्ततेसाठी आवश्यक असलेल्या वेगवेगळ्या प्रकारच्या सेवा सुविधा अशा सर्वांचा समावेश मानवी आर्थिक क्रियांमध्ये केला जातो. प्रस्तुत पुस्तकात आर्थिक भूगोलाचा परिचय, अभ्यास पद्धती, विविध शास्त्रांशी असलेले संबंध, विविध आर्थिक क्रिया, जगातील संसाधने, भारतीय अर्थव्यवस्था, शेती, वाहतूक, व्यापार, उद्योगधंदे, कारखानदारी, प्रादेशिक विकास, ग्रामीण विकास या विविध मुद्द्यांचे सर्वांगीण विवेचन केले आहे.



Download
Prashant Publications
app for e-Books

Also e-Books are available online at

- kopykitab.com
- amazon.com
- play.google.com
- www.prashantpublications.com



भूगोल ₹ 325

ISBN 978-81-947898-3-3



www.prashantpublications.com
prashantpublication.jal@gmail.com

32. Geography of Maharashtra (Physical)-I

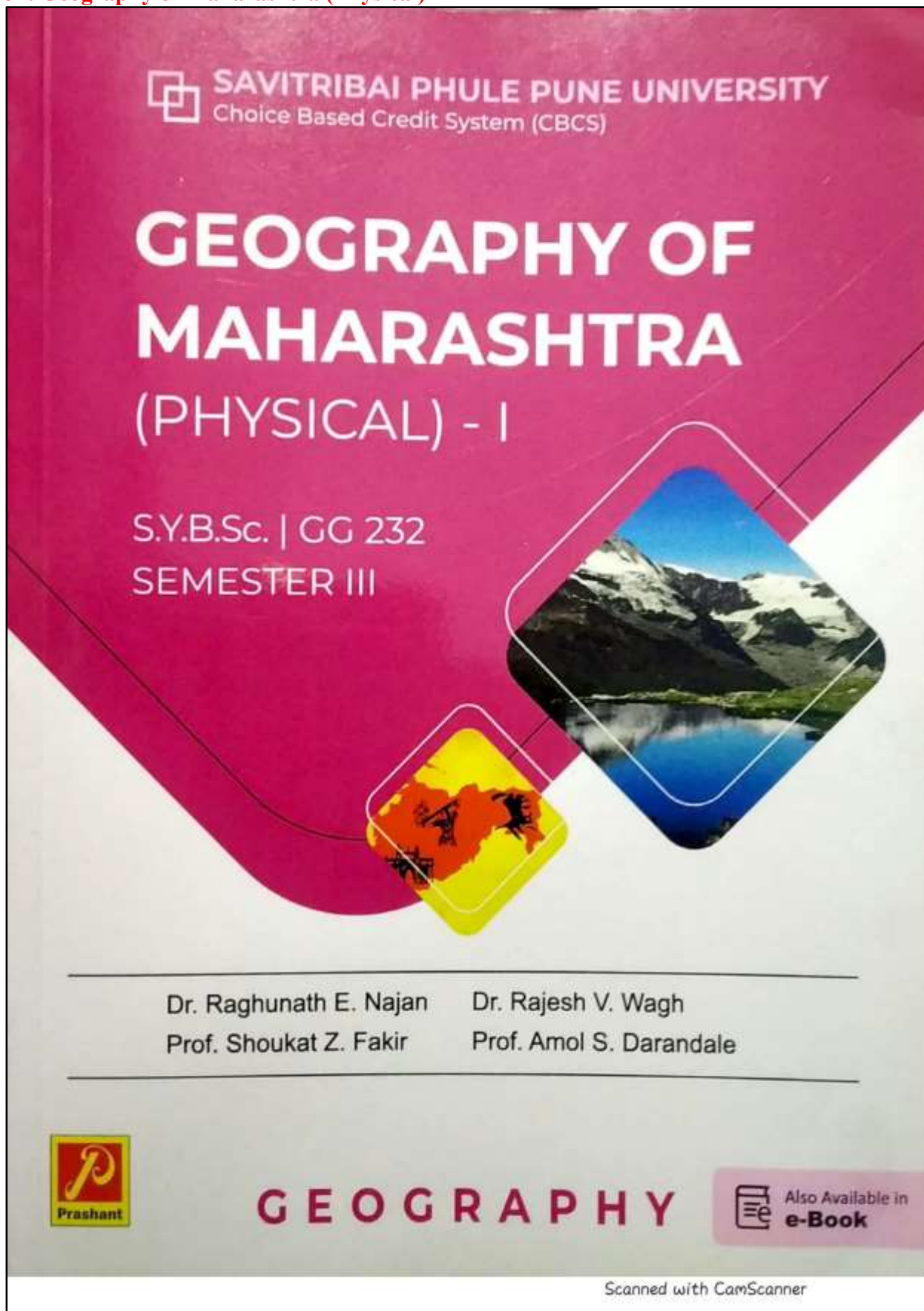

**S.Y.B.Sc.
TEXT BOOKS**

**SAVITRIBAI PHULE
PUNE UNIVERSITY**
w.e.f. June 2020,
(CBCS PATTERN)

Physics

PHY - 231	Mathematical Methods in Physics-I	PHY - 241	Oscillations, Waves & Sound
PHY - 232	Electronics (A)	PHY - 242	Optics
PHY - 232	Instrumentation (B)	PHY - 233 & 243	Physics Practical

Chemistry

CH - 301	Physical & Analytical Chemistry	CH - 401	Physical & Analytical Chemistry
CH - 302	Inorganic & Organic Chemistry	CH - 402	Inorganic & Organic Chemistry
CH - 303	Practical Chemistry	CH - 403	Practical Chemistry

Botany

BO - 231	Taxonomy of Angios. & Plant Ecology	BO - 241	Plant Anatomy & Embryology
BO - 232	Plant Physiology	BO - 242	Plant Biotechnology
BO - 233 & 243	Practical Botany		

Zoology

ZO - 231	Animal Diversity III	ZO - 241	Animal Diversity IV
ZO - 232	Applied Zoology I	ZO - 242	Applied Zoology II
ZO - 233 & 243	Zoology Practical		

PRASHANT PUBLICATIONS

3, Pratap Nagar, Shri Sant Dnyaneshwar Mandir Road,
Near Nutan Maratha College, Jalgaon - 425 001. (India)
Ph. : 0257-2235520, 2232800, **Mob. :** 9421636460, 9665626717
E-Mail : prashantpublication.jal@gmail.com
Visit us : www.prashantpublications.com

**DOWNLOAD
OUR APP!
for E-Books**



Also E-Books are available online at :



Visit us at

www.prashantpublications.com

Books + e-Books



₹ 150

ISBN 978-93-90483-66-2



Scanned with CamScanner

33. Financial System

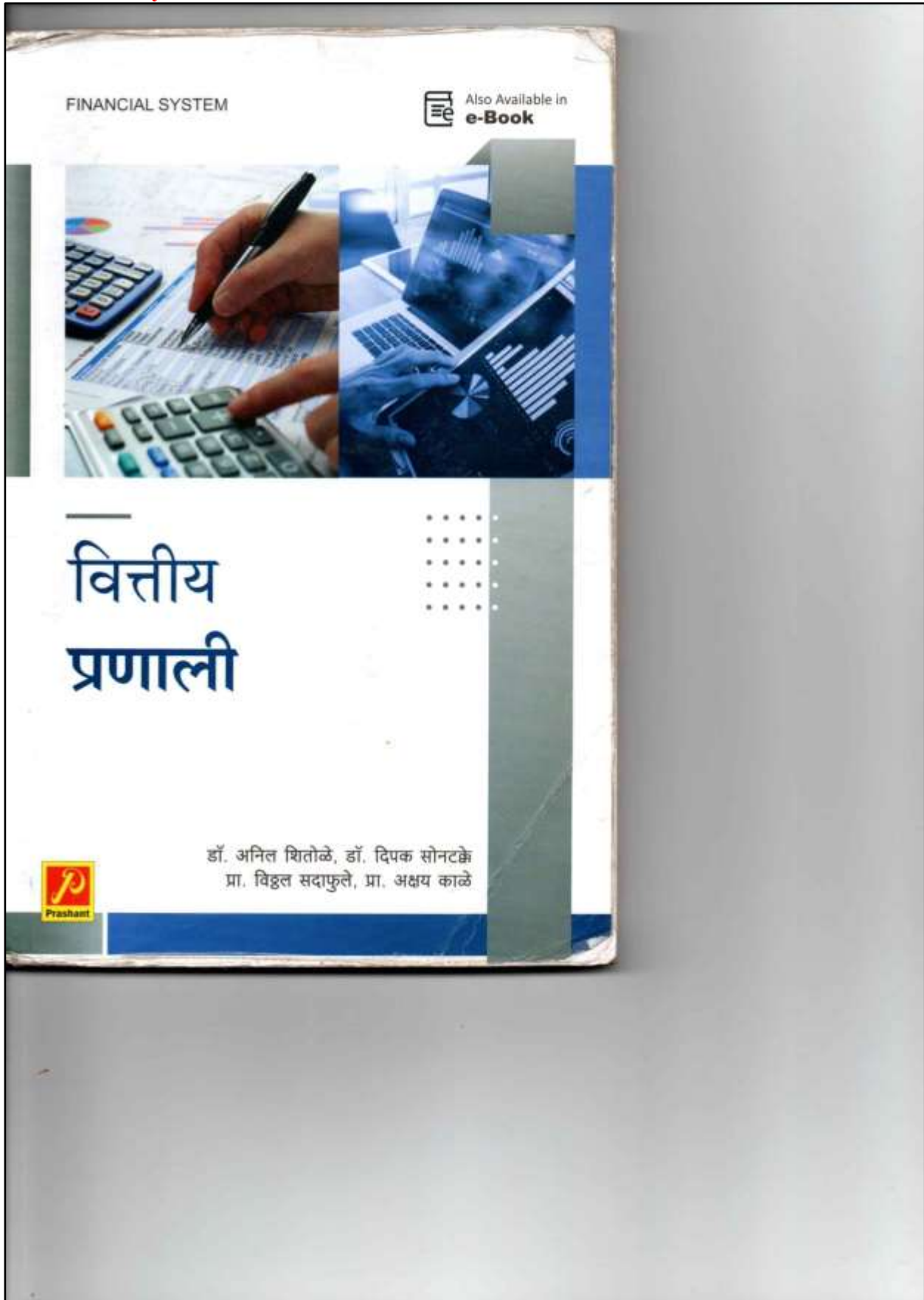

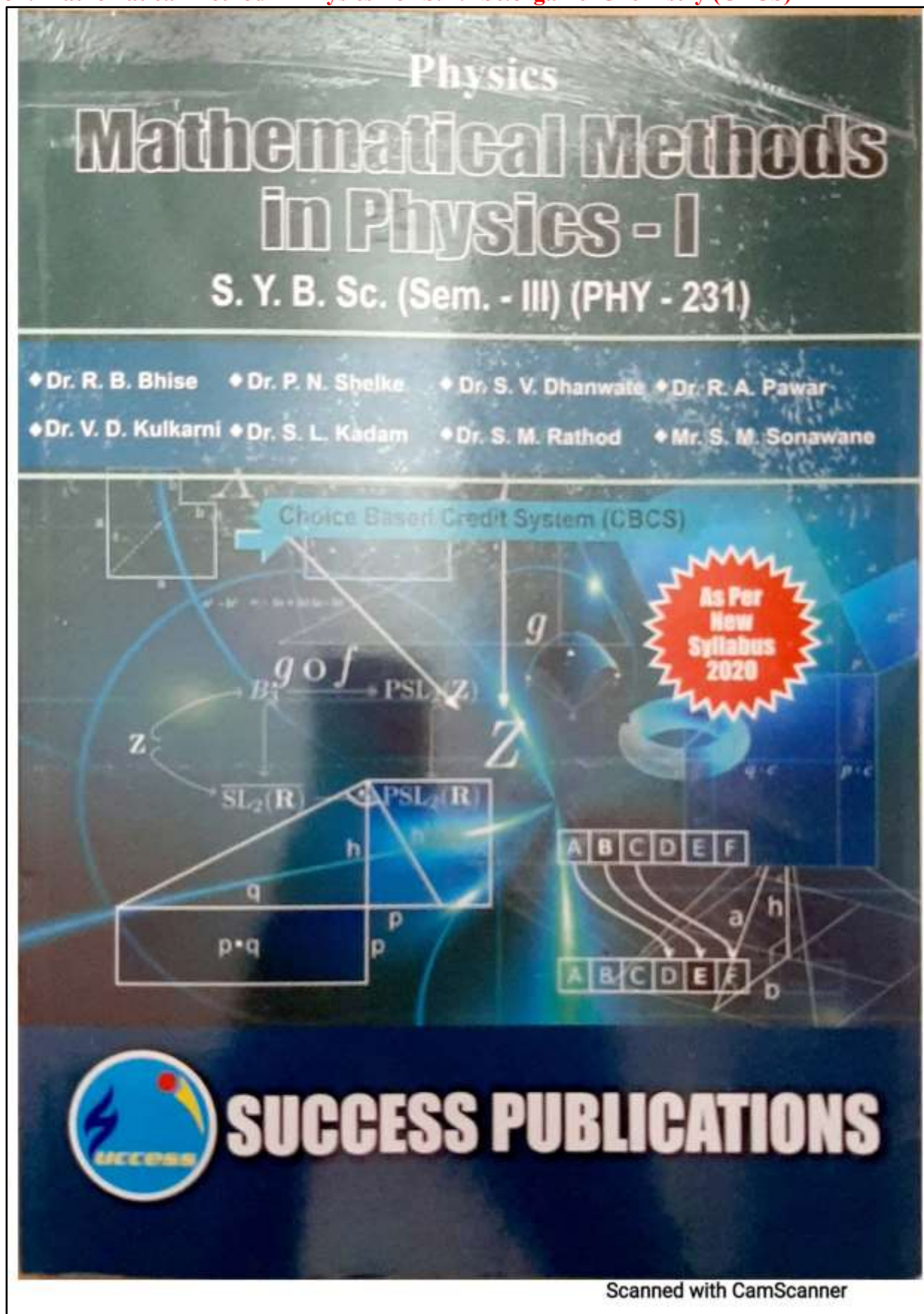

34. Mathematical Method in Physics For S.Y.BSc.organic Chemistry (CBCS)

ISBN : 978-81-946728-6-9

SUCCESS PUBLICATIONS

Address : Radha Krishna Apartment, 535, Shaniwar Peth,
 Appa Balwant Chowk, Opp. Prabhat Theatre, Pune - 30.
 Ph. No. 24434662, Mobile : 9325315464
 E-mail : sharpgroup31@rediffmail.com
 Website : www.sharpmultinational.com

PT-3538

Scanned with CamScanner

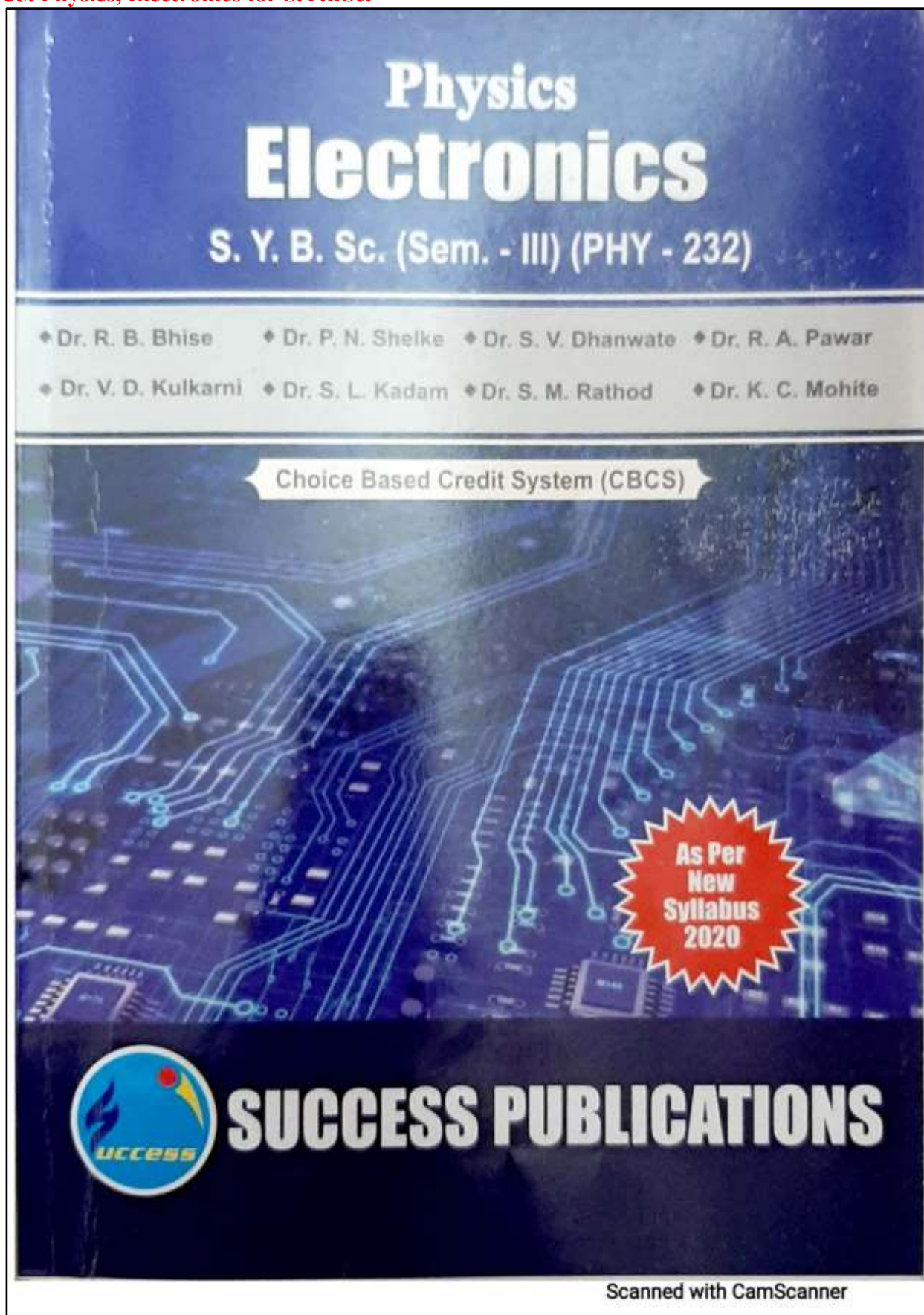
35. Physics, Electronics for S.Y.BSc.

ISBN : 978-81-946728-5-2

SUCCESS PUBLICATIONS

Address : Radha Krishna Apartment, 535, Shaniwar Peth,
Appa Balwant Chowk, Opp. Prabhat Theatre, Pune - 30,
Ph. No. 24434662, Mobile : 9325315464
E-mail : sharpgroup31@rediffmail.com
Website : www.sharpmultinational.com

PT-3539

36. Applied Research In Botany**APPLIED RESEARCH IN
BOTANY VOLUME-1**

Dr. Anil Laxman Bhalerao
[M.Sc. Ph.D.]

Dr. Rajesh Shirangrao Gaikwad
[M.Sc. Ph.D.]

mp mahi
Publication

ISBN: 978-93-90651-59-7

First Edition: 2021

This book is sold subject to the condition that it shall not, by way of trade or otherwise, be lent, resold, hired out, or otherwise circulated without the publisher's prior written consent in any form of binding or cover other than that in which it is published and without a similar condition including this condition being imposed on the subsequent purchaser and without limiting the rights under copyright reserved above, no part of this publication may be reproduced, stored in or introduced into a retrieval system, or transmitted in any form or by any means (electronic, mechanical, photocopying or recording) otherwise without the prior written permission of both the copyright owner and the above-mentioned publisher of this book.

PRICE ₹ 399/-

PUBLISHER
MAHI PUBLICATION

 Office No.1, Krishnasagar Society, Nr. Shivsagar sharda Mandir Road,
Ahmedabad-380007

 mahibookpublication@gmail.com

 +(91) 798 422 6340

 www.mahipublication.com

Copyright © 2021\ MAHI PUBLICATION

Dedicated to

Our Esteemed Teachers

Dr. D. S. Mukadam

Ex. Professor and Head

Department of Botany,

Dr. Babasaheb Ambedkar Marathwada University,

Aurangabad.431004 (M.S) India.

.....

Dr. V. S. Kothekar

Ex. Professor and Head

Department of Botany,

Dr. Babasaheb Ambedkar Marathwada University,

Aurangabad.431004 (M.S) India.

SR. NO.	TITLE OF THE RESEARCH PAPER	NAME OF AUTHOR	PAGE NO.
1	EFFICIENCY OF MYCORRHIZAE AND PGPF FOR GROWTH PERFORMANCE ON CHILI CV SITARA	PROF. DR. UDHAV N. BHALE	9
2	EFFECT OF MYCORRHIZA ON CHEMICAL COMPOSITION OF THE <i>TAJETES ERECTA</i> , L AND <i>CATHARANTHUS ROSEUS</i> , L	PRINCIPAL DR. RANGNATH AHER	19
3	EXPLORATION OF EMERGENCY HERBAL FOOD RESOURCES OF TRIBAL PEOPLE FROM THE RAIGAD DISTRICT OF THE MAHARASHTRA STATE, INDIA.	DR. KALPIT MHATRE AND PRINCIPAL DR. RAJENDRA SHINDE	25
4	EFFECT OF GA+ IAA AND GA+ NAA PRE-TREATMENTS ON SEED GERMINABILITY AND ROOTING OF STEM CUTTINGS OF <i>JATROPHA</i> SPECIES.	DR. RAJESH SHRIRANGRAO GAIKWAD	29
5	GENETICALLY MODIFIED DISEASE RESISTANT FRENCH BEANS (<i>PHASEOLUS VULGARIS</i> L.) AS AN IMMUNE BOOSTER- A REVIEW	SHREYA DOGRA & NARAYAN TOTEWAD	37
6	EFFECT OF PEG-6000 INDUCED WATER STRESS ON PHYTOCHEMICALS IN WHEAT CULTIVARS (<i>TRITICUM AESTIVUM</i> L.)	DR.DESHMUKH R.N. & SAWANT K.S.	48
7	COMPARATIVE STUDY ON DIFFERENT CLEARING METHODS FOR THE PREPARATION OF LEAF VENATION OF LEAVES.	SAIMA RASHID MIR, B.M. SHINDE AND M.M JANA	55
8	ETHNOMEDICINAL PLANTS USED BY KOKNI TRIBAL OF NASIK AND DHULE DISTRICTS FOR TREATMENT OF PILES (MAHARASHTRA)	SACHIN D. KUVAR AND DR. RAJENDRA D. SHINDE	60
9	EFFECT OF MEDICINAL PLANTS ON PATHOGENIC FUNGI	RAFI AHMED, SACHIN CHAVAN AND RUKHSAR BANO ANSARI	66
10	ADDITION OF SACRED GROVE FROM RAIGAD DISTRICT FOR THE STATE OF MAHARASHTRA	DR. KALPIT MHATRE	75
11	EFFECT OF NITROGENOUS WASTE WATER OF BUFFALO STABLE ON GROWTH PARAMETERS OF SOME VEGETABLES IN MUMBAI	NISHA SUTAR AND ANIL BHALERAO	82
12	FLORISTIC DIVERSITY OF PLATEAUS IN DEVGAD, SINDHUDURG, MAHARASHTRA AND NEED FOR THEIR CONSERVATION	DR. ALOK GUDE AND KALPIT MHATRE	95

Applied research in Botany Volume-1

13	USE OF NATURAL FLORAL EXTRACTS AS PH INDICATORS	ANKIT YADAV, NIKUNJ SULE AND PRATIKSHA KARADE	97
14	FUNGAL CONTAMINATION OF PAPER CURRENCY POSSESSED BY DIFFERENT OCCUPATIONERS AND ITS CONTROL	DR. RAJENDRA B. KAKDE	103
15	EFFECT OF NITROGENOUS WASTE WATER OF BUFFALO STABLE ON NUTRIENTS OF SOME VEGETABLES	NISHA SUTAR AND ANIL BHALERAO	111
16	OCCURRENCE OF AM FUNGI IN <i>CASSIA TORA L.</i> PLANTS OF OSMANABAD DISTRICT	PRAKASH SARWADE, SHAHAJI S. CHANDANSHIVE, VIKAS P.SARWADE AND KAVITA N. GAISAMUDRE	118
17	EFFECT OF COOKING AND STORAGE CONDITIONS ON THE NUTRITIVE VALUE OF <i>DOLICHOS</i> BEANS,	SURVE SHIVANI A. AND BHAGAT SACHIN S.	123
18	STUDY OF SEASONAL VARIATION IN LEAF CHLOROPHYLL CONTENT OF SOME TREE SPECIES OF HINGOLI REGION (M.S.)	DR. KIRANKUMAR KHANDARE	128
19	USE OF <i>POLYALTHIA LONGIFOLIA</i> AS BIOPESTICIDE: ADVANCEMENT TO TREAT FUNGAL DISEASE OF SOME MEDICINAL PLANTS	DR. MANISHA S. SUTARE	133
20	INVESTIGATION OF PHYSICO-CHEMICAL AND BIOACTIVE PROPERTIES OF HONEY FROM THE RAIGAD DISTRICT OF MAHARASHTRA STATE	KALPIT MHATRE AND ALOK GUDE	137
21	PROXIMATE ANALYSIS OF <i>PORTULACARIA AFRA.</i> JACQ.	RUCHIRA JAVKAR AND ANIL AVHAD	143
22	DIVERSITY OF MANGROVES AT JAITAPUR (RATNAGIRI DISTRICT), MAHARASHTRA STATE	DR. KALPIT MHATRE, RAJENDRA SHEVDE AND MAHADEO BADGE	149
23	PRODUCTION OF CYANOBACTERIAL BIOFERTILIZER AND ITS APPLICATION IN PADDY FIELDS.	A. A. ATNOORKAR	155
24	TRADITIONAL USES OF MEDICINAL PLANTS BY RURAL ZONE OF SAIKHEDA TAL-NIPHAD, DIST-NASHIK (MS)	S.V. GOSAVI	163
25	EFFECT OF STORAGE CONTAINER AND STORAGE PERIOD ON INCIDANCE OF FUNGI OF FOODGRAINS	ANIL U. KULKARNI, AND ASHOK M. CHAVAN	171
26	EFFECT OF MEDICINAL PLANTS LEAF EXTRACTS ON GROWTH AND SPORULATION OF FUNGI.	ANIL N. KORPENWAR AND DEEPMALA A . GAIKWAD	188
27	6 CURRENT STATUS OF RESEARCH ON MUSHROOM CULTIVATION IN INDIA	YUVRAJ D. KENGAR ILAH I. MUJAWAR AND NARAYAN D. TOTEWAD	195

I
N
D
E
X

37. CH-302: Inorganic and Organic Chemistry (CBCS)

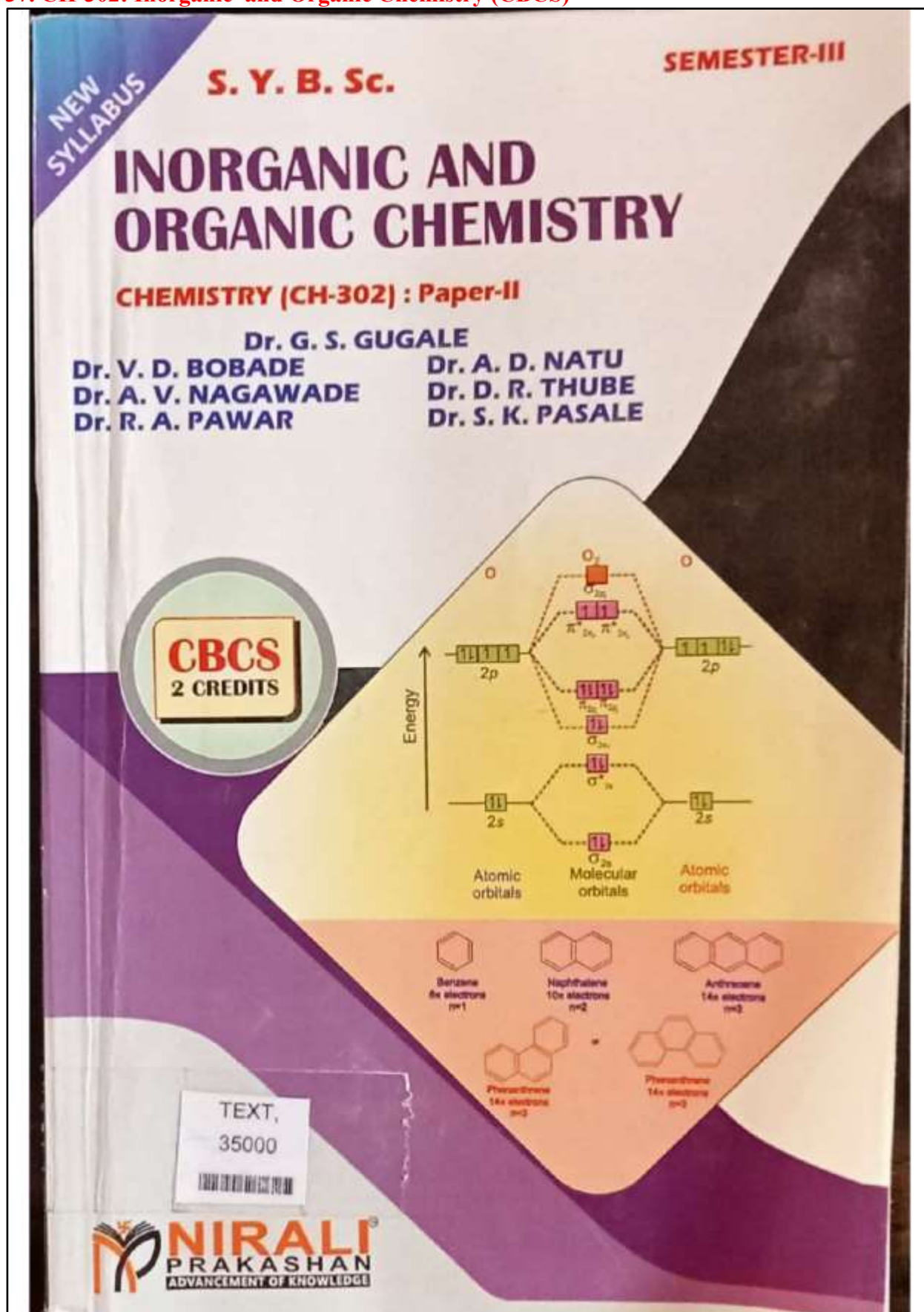

S.Y.B.Sc. INORGANIC AND ORGANIC CHEMISTRY ISBN : 978-93-90225-36-1

First Edition : July 2020

© : **Authors**

The text of this publication, or any part thereof, should not be reproduced or transmitted in any form or stored in any computer storage system or device for distribution including photocopy, recording, taping or information retrieval system or reproduced on any disc, tape, perforated media or other information storage device etc., without the written permission of Authors with whom the rights are reserved. Breach of this condition is liable for legal action.

Every effort has been made to avoid errors or omissions in this publication. In spite of this, errors may have crept in. Any mistake, error or discrepancy so noted and shall be brought to our notice shall be taken care of in the next edition. It is notified that neither the publisher nor the authors or seller shall be responsible for any damage or loss of action to any one, of any kind, in any manner, therefrom.

Published By:

NIRALI PRAKASHAN

Abhyudaya Pragati, 1312, Shivaji Nagar
Off J.M. Road, PUNE – 411005
Tel - (020) 25512336/37/39, Fax - (020) 25511379
Email : niralipune@pragationline.com

Polyplate

YOGIRAJ PRINTERS AND BINDERS

Works: Sr. No. 10/1, Ghule Industrial Estate,
Nanded Village Road,
TAL-HAVELI, DIT-PUNE 411041.
Mobile - 9850046517, 9404233041

Printed By:

➤ **DISTRIBUTION CENTRES**

PUNE

Nirali Prakashan : 119, Budhwar Peth, Jogeshwari Mandir Lane, Pune 411002,
(For orders within Pune) Maharashtra, Tel : (020) 2445 2044, Mobile : 9657703145
Email : niralilocal@pragationline.com

Nirali Prakashan : S. No. 28/27, Dhayari, Near Asian College Pune 411041
(For orders outside Pune) Tel : (020) 24690204; Mobile : 9657703143
Email : bookorder@pragationline.com

MUMBAI

Nirali Prakashan : 385, S.V.P. Road, Rasdhara Co-op. Hsg. Society Ltd.,
Girgaum, Mumbai 400004, Maharashtra;
Mobile : 9320129587 Tel : (022) 2385 6339 / 2386 9976,
Fax : (022) 2386 9976
Email : niralimumbai@pragationline.com

➤ **DISTRIBUTION BRANCHES**

JALGAON

Nirali Prakashan : 34, V. V. Golani Market, Navi Peth, Jalgaon 425001,
Maharashtra, Tel : (0257) 222 0395, Mob : 94234 91860;
Email : niralijalgaon@pragationline.com

KOLHAPUR

Nirali Prakashan : New Mahadvar Road, Kedar Plaza, 1st Floor Opp. IDBI Bank,
Kolhapur 416 012, Maharashtra. Mob : 9850046155;
Email : niralikolhapur@pragationline.com

NAGPUR

Nirali Prakashan : Above Maratha Mandir, Shop No. 3, First Floor,
Rani Jhanshi Square, Sitabuldi, Nagpur 440012, Maharashtra
Tel : (0712) 254 7129;
Email : niralinagpur@pragationline.com

DELHI

Nirali Prakashan : 4593/15, Basement, Agarwal Lane, Ansari Road, Daryaganj
Near Times of India Building, New Delhi 110002
Mob : 08505972553, Email : niralidelhi@pragationline.com

BENGALURU

Nirali Prakashan : Maitri Ground Floor, Jaya Apartments, No. 99, 6th Cross,
6th Main, Malleswaram, Bengaluru 560003, Karnataka;
Mob : 9449043034
Email : niralibangalore@pragationline.com

Other Branches : Hyderabad, Chennai

niralipune@pragationline.com | www.pragationline.com

Also find us on f www.facebook.com/niralibooks

Contents ...

1. **Molecular Orbital Theory of Covalent Bonding** 1.1 – 1.52

2. **Introduction to Co-ordination Compounds** 2.1 – 2.30

3. **Aromatic Hydrocarbons** 3.1 - 3.20

4. **Alkyl and Aryl Halides** 4.1 – 4.46

5. **Alcohols, Phenols and Ethers**
(Upto 5 Carbons) 5.1 - 5.34

- **Model Question Paper** P.1 – P.2

38. CH-402: Inorganic and Organic Chemistry (CBCS)

NEW SYLLABUS

S. Y. B.Sc.

SEMESTER-IV

INORGANIC AND ORGANIC CHEMISTRY

CHEMISTRY (CH-402) : PAPER-II

Dr. G. S. GUGALE
Dr. D. R. THUBE
Dr. S. K. PASALE

Dr. V. D. BOBADE
Dr. A. V. NAGAWADE
Dr. R. A. PAWAR

CBCS
2 CREDITS

The diagram illustrates the crystal field splitting of d-orbitals in an octahedral ligand field. It shows the energy levels for a free metal ion (unsplit level), a hypothetical symmetrical ligand field (unsplit level), and the splitting into e_g and t_{2g} levels in an octahedral field. The energy difference is labeled as Δ_o ($10D_q$).

Free metal ion
Hypothetical (Symmetrical Ligand field) unsplit level
Splitting in octahedral Ligand field

$e_g (d_{z^2}, d_{x^2-y^2})$
 $+6D_q$
Average level
 $-4D_q$
 $t_{2g} (d_{xy}, d_{yz}, d_{zx})$

Chair structure of cyclohexane

Diagram illustrating the chair structure of cyclohexane, showing the arrangement of hydrogen atoms (H) on the ring.

NIRALI PRAKASHAN
ADVANCEMENT OF KNOWLEDGE

S.Y.B.Sc. INORGANIC AND ORGANIC CHEMISTRY ISBN : 978-93-90506-97-2

First Edition : January 2021

© : **Authors**

The text of this publication, or any part thereof, should not be reproduced or transmitted in any form or stored in any computer storage system or device for distribution including photocopy, recording, taping or information retrieval system or reproduced on any disc, tape, perforated media or other information storage device etc., without the written permission of Authors with whom the rights are reserved. Breach of this condition is liable for legal action.

Every effort has been made to avoid errors or omissions in this publication. In spite of this, errors may have crept in. Any mistake, error or discrepancy so noted and shall be brought to our notice shall be taken care of in the next edition. It is notified that neither the publisher nor the authors or seller shall be responsible for any damage or loss of action to any one, of any kind, in any manner, therefrom.

Published By:

NIRALI PRAKASHAN

Abhyudaya Pragati, 1312, Shivaji Nagar,
Off J.M. Road, PUNE - 411005

Tel - (020) 25512336/37/39, Fax - (020) 25511379

Email : niralipune@pragationline.com

Polyplate

YOGIRAJ PRINTERS AND BINDERS

Works: Sr. No. 10/1, Ghule Industrial Estate,

Nanded Village Road,

TAL-HAVELI, DIST-PUNE 411041.

Mobile - 9850046517, 9404233041

Printed By:

➤ **DISTRIBUTION CENTRES**

PUNE

Nirali Prakashan : 119, Budhwar Peth, Jogeshwari Mandir Lane, Pune 411002,
(For orders within Pune) Maharashtra, Tel : (020) 2445 2044, Mobile : 9657703145
Email : niralilocal@pragationline.com

Nirali Prakashan : S. No. 28/27, Dhayari, Near Asian College Pune 411041
(For orders outside Pune) Tel : (020) 24690204; Mobile : 9657703143
Email : bookorder@pragationline.com

MUMBAI

Nirali Prakashan : 385, S.V.P. Road, Rasdhara Co-op. Hsg. Society Ltd.,
Girgaum, Mumbai 400004, Maharashtra;
Mobile : 9320129587 Tel : (022) 2385 6339 / 2386 9976,
Fax : (022) 2386 9976
Email : niralimumbai@pragationline.com

➤ **DISTRIBUTION BRANCHES**

JALGAON

Nirali Prakashan : 34, V. V. Golani Market, Navi Peth, Jalgaon 425001,
Maharashtra, Tel : (0257) 222 0395, Mob : 94234 91860;
Email : niralijalgaon@pragationline.com

KOLHAPUR

Nirali Prakashan : New Mahadvar Road, Kedar Plaza, 1st Floor Opp. IDBI Bank,
Kolhapur 416 012, Maharashtra. Mob : 9850046155;
Email : niralikolhapur@pragationline.com

NAGPUR

Nirali Prakashan : Above Maratha Mandir, Shop No. 3, First Floor,
Rani Jhanshi Square, Sitabuldi, Nagpur 440012, Maharashtra
Tel : (0712) 254 7129;
Email : niralinagpur@pragationline.com

DELHI

Nirali Prakashan : Room No. 2, Ground Floor, 4575/15 Onkar Tower,
Aggarwal Road, Daryaganj New Delhi 110002
Mob : +91 9555778814 / +91 9818561840
Email : niralidelhi@pragationline.com

BENGALURU

Nirali Prakashan : Maitri Ground Floor, Jaya Apartments, No. 99, 6th Cross,
6th Main, Malleswaram, Bengaluru 560003, Karnataka;
Mob : 9449043034
Email : niralibangalore@pragationline.com

Other Branches : Hyderabad, Chennai

niralipune@pragationline.com | www.pragationline.com

Also find us on  www.facebook.com/niralibooks

Contents ...

- 1. Isomerism in Coordination Complexes** 1.1 - 1.16
- 2. Valence Bond Theory of Coordination Compounds**
2.1 - 2.16
- 3. Crystal Field Theory** 3.1 - 3.36
- 4. Aldehydes and Ketones (Aliphatic and Aromatic)**
4.1 - 4.28
- 5. Carboxylic Acids and their Derivatives** 5.1 - 5.22
- 6. Amines and Diazonium Salts** 6.1 - 6.24
- 7. Stereochemistry of Cyclohexane** 7.1 - 7.24

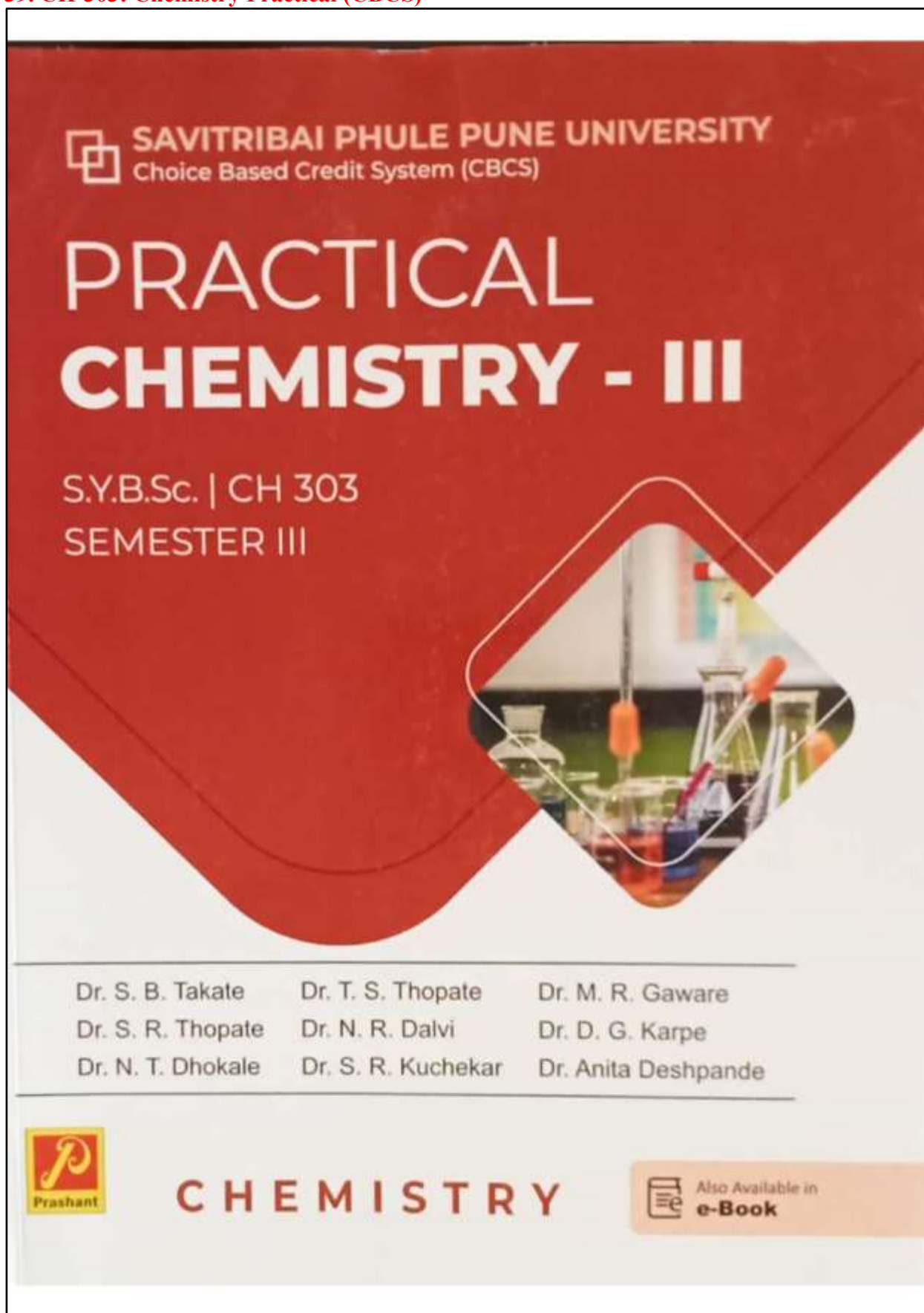
39. CH-303: Chemistry Practical (CBCS)



**Prashant
Publications**

© Reserved

PRACTICAL CHEMISTRY-III

S.Y.B.Sc. | Sem III | CH - 303

Publisher and Printer

Prashant Publications
3, Pratap Nagar, Shri Sant Dnyaneshwar Mandir Road,
Near Nutan Maratha College, Jalgaon 425001.

• Phone • Website • E-mail

(0257) 2235520, 2232800
www.prashantpublications.com
prashantpublication.jal@gmail.com

• First Edition • ISBN • Type Setting

August, 2020
978-93-89501-67-4
Prashant Publication

Price : ₹ 75/-

e-Books are available online at www.prashantpublications.com

 **Prashant Publications app for e-Books**
kopykitab.com • amazon.com • play.google.com

All rights reserved. No part of this publication may be reproduced, stored in a retrieval system or transmitted, in any form or by any means, electronic, mechanical, photocopying (xerox copy), recording or otherwise, without the prior permission.

ii

Contents

CH-303: CHEMISTRY PRACTICAL

A. Chemical Kinetics: Integrated rate method: (Any Three)

Experiment No. 1	7
To Study the Acid catalysed hydrolysis of an ester (methyl Acetate) and determine the rate constant (k). (first order reaction).	
Experiment No. 2	10
To compare the relative strength of HCl and H_2SO_4 or HNO_3 by studying the kinetics of hydrolysis of methyl acetate	
Experiment No. 3	13
To study the kinetics of saponification reaction between sodium hydroxide and ethyl acetate.	
Experiment No. 4	16
To determine energy of activation of the reaction between $K_2S_2O_8$ and KI.	
Experiment No. 5	20
To determine the order of the reaction with respect to $K_2S_2O_8$ by fractional life method following the kinetics of per sulphate iodide reaction.	

B. Inorganic quantitative / qualitative analysis (Any two)

Experiment No. 1	25
Estimation of Fe(III) from given solution by converting it to Fe(II) using Zn metal and then by titrating with standard solution of $K_2Cr_2O_7$ -A Green Approach.	
Experiment No. 2	29
Determination of $BaCO_3$ content in a given sample by precise determination of volume of CO_2 .	
Experiment No. 3	35
Separation and Identification of metal ions by Paper Chromatography .	

C. Organic Qualitative Analysis (Two mixtures: solid-solid type)

Experiment No. 1	39
Separation of Two Components from given binary mixture of organic compounds containing mono-functional group (Ex. - carboxylic acid, phenols, amines, amide, nitro, etc.) and systematic identification of each component qualitatively.	

D. Organic Preparations (Any two)	
Experiment No. 1	65
Preparation of benzoic acid from ethyl benzoate (Identification and confirmatory Test of -COOH group, M.P and purity by TLC) .	
Experiment No. 2	67
Acetylation of primary amine (Green approach) .	
Experiment No. 3	69
Base catalyzed Aldol condensation (Green approach)	
Practical No. 4	71
Preparation of Quinone from hydroquinone (Confirm the conversion by absence of phenolic -OH group in product, M.P and purity by TLC)	
E. pH Metry (Compulsory)	
Experiment No. 1	73
To determine equivalence point of neutralization of acetic acid by pH-metric titration with NaOH and to find best indicator for the titration.	
F. Volumetric Analysis (Any two)	
Experiment No. 1	76
Estimation of Aspirin from a given tablet and find errors in quantitative analysis. (Standardization of acid must be performed with standard Na ₂ CO ₃ solution, prepared from dried anhydrous AR grade Na ₂ CO ₃)	
Experiment No. 2	82
Determination of acetic acid in commercial vinegar by titrating with standard NaOH. Express your results as average ± standard deviation. (Standardization of base must be performed with standard KHP).	
Experiment No. 1	88
. Determination of Hardness of water from given sample by complexometric titration (Using E.D.T.A.) method and total dissolve solids by conductometry. Express your results as average ± standard deviation. (Standardization of Na ₂ EDTA must be performed with standard Zn(II) solution)	
• G. Mini Scale Project (Choice Based Activity)	93
• H. Students Short Activities (for both semesters)	95

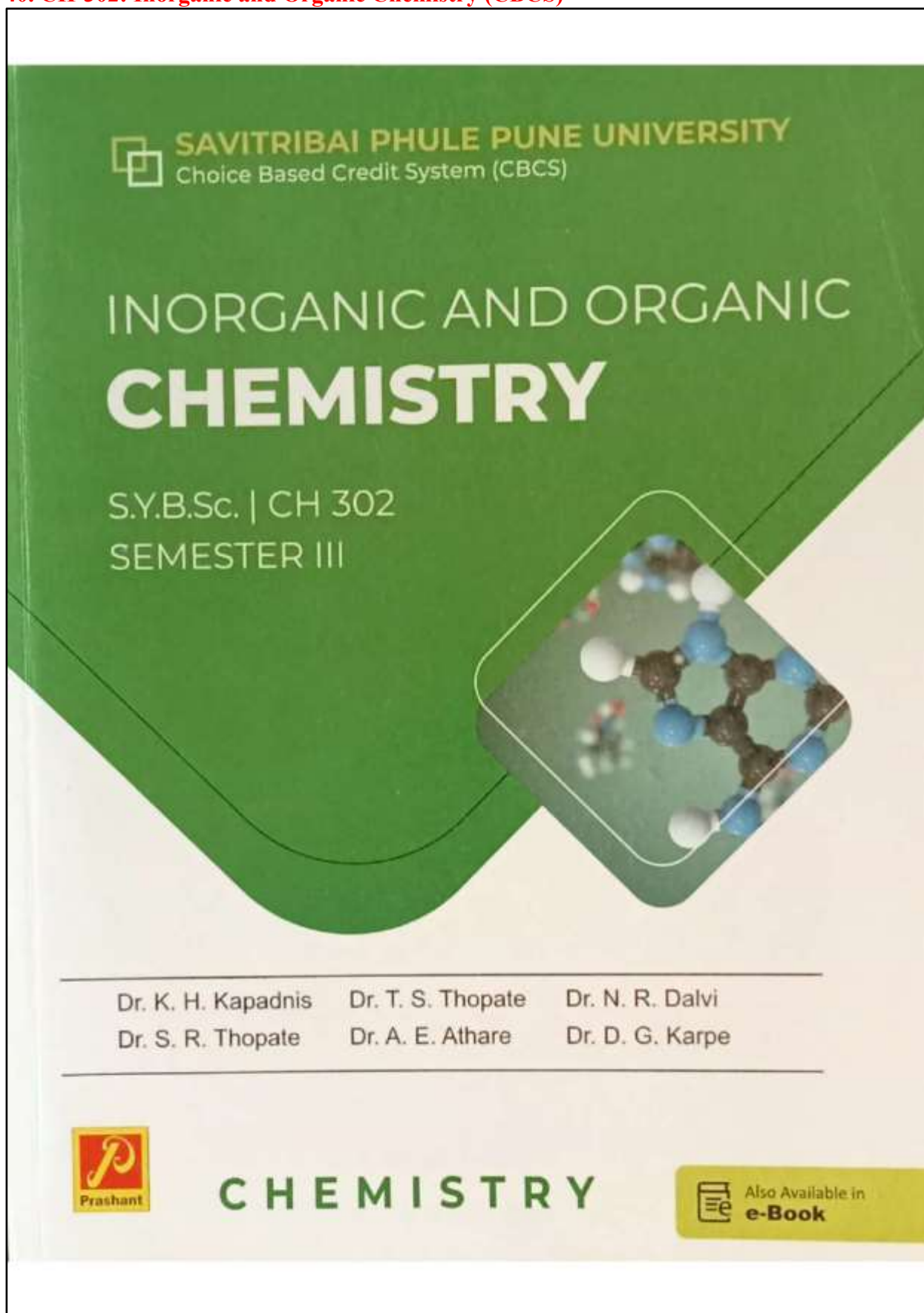
40. CH-302: Inorganic and Organic Chemistry (CBCS)



**Prashant
Publications**

© Reserved

INORGANIC AND ORGANIC CHEMISTRY

S.Y.B.Sc. | Sem III | CH 302

Publisher and Printer

Prashant Publications
3, Pratap Nagar, Shri Sant Dnyaneshwar Mandir Road,
Near Nutan Maratha College, Jalgaon 425001.

. Phone . Website . E-mail

(0257) 2235520, 2232800
www.prashantpublications.com
prashantpublication.jal@gmail.com

. First Edition . ISBN . Type Setting

August, 2020
978-93-89501-66-7
Prashant Publication

Price : ₹ 85/-

e-Books are available online at www.prashantpublications.com

Prashant Publications app for e-Books

kopykitab.com • amazon.com • play.google.com

All rights reserved. No part of this publication may be reproduced, stored in a retrieval system or transmitted, in any form or by any means, electronic, mechanical, photocopying (xerox copy), recording or otherwise, without the prior permission.

ii

Contents

1. Molecular Orbital Theory	07
2. Introduction to Coordination Chemistry	36
3. Aromatic Hydrocarbons	56
4. Alkyl and Aryl Halides.....	65
5. Alcohols, Phenols and Ethers	83

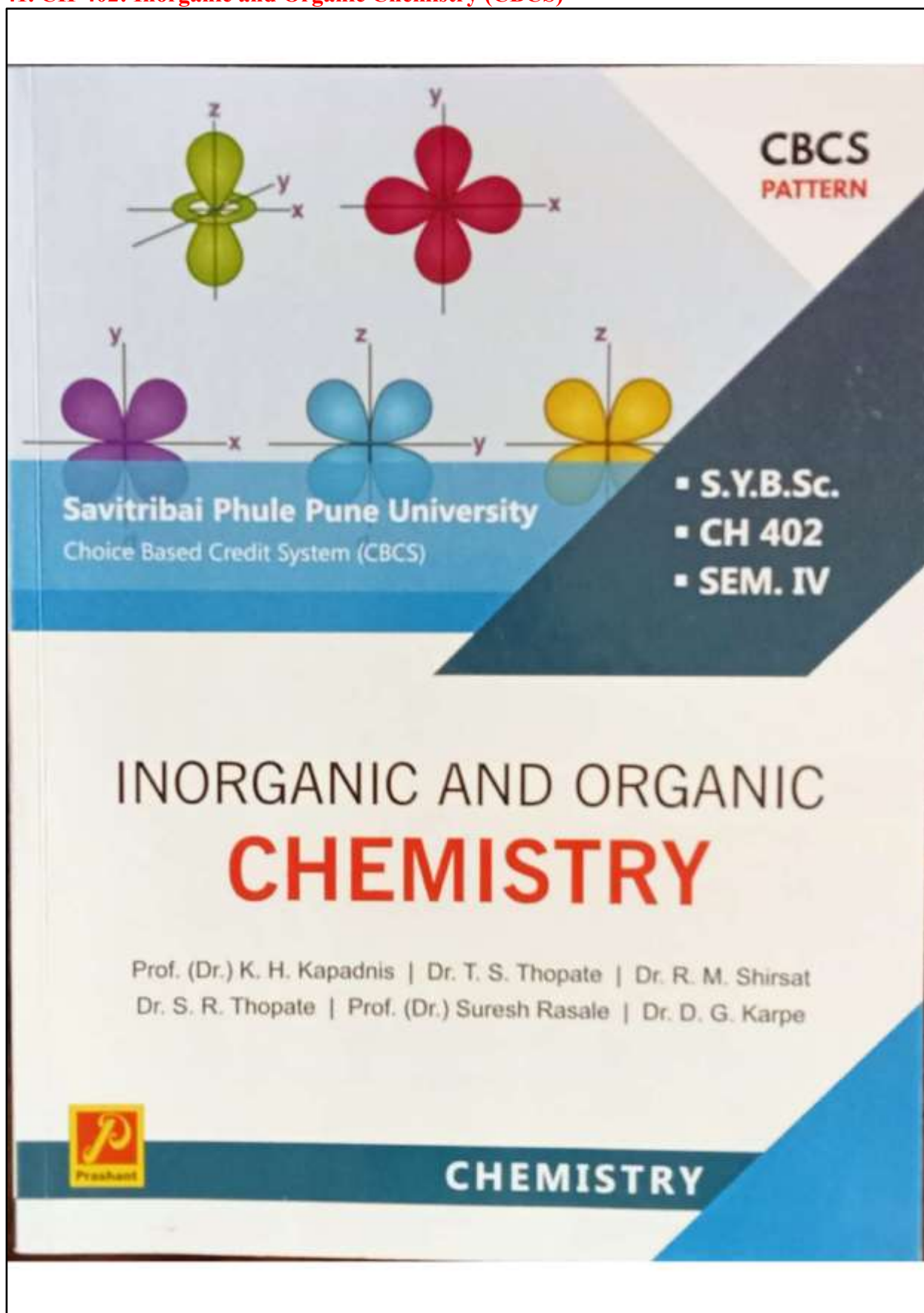
41. CH-402: Inorganic and Organic Chemistry (CBCS)



**Prashant
Publications**

© Reserved

INORGANIC AND ORGANIC CHEMISTRY

S.Y.B.Sc. | Sem IV | CH 402

Publisher and Printer

Prashant Publications

3, Pratap Nagar, Shri Sant Dnyaneshwar Mandir Road,
Near Nutan Maratha College, Jalgaon 425001.

. Phone . Website . E-mail

(0257) 2235520, 2232800

www.prashantpublications.com

prashantpublication.jal@gmail.com

. First Edition . ISBN . Type Setting

February, 2021

978-93-90483-62-4

Prashant Publication

Price : ₹ 95/-

e -Books are available online at www.prashantpublications.com

 **Prashant Publications** app for e-Books

kopykitab.com • amazon.com • play.google.com

All rights reserved. No part of this publication may be reproduced, stored in a retrieval system or transmitted, in any form or by any means, electronic, mechanical, photocopying (xerox copy), recording or otherwise, without the prior permission.

ii

Contents

1. Isomerism in Coordination Complexes.....	07
2. Valance Bond Theory of Coordination Compounds	23
3. Crystal Field Theory.....	35
4. Aldehydes and Ketones (Aliphatic and Aromatic).....	58
5. Carboxylic Acids and Their Derivatives	76
6. Amines and Diazonium Salts	87
7. Stereochemistry of Cyclohexane.....	99

42. CH-303: Chemistry Practical (CBCS)



 **SAVITRIBAI PHULE PUNE UNIVERSITY**
Choice Based Credit System (CBCS)

PRACTICAL CHEMISTRY - III

S.Y.B.Sc. | CH 303
SEMESTER III



Dr. S. B. Takate	Dr. T. S. Thopate	Dr. M. R. Gaware
Dr. S. R. Thopate	Dr. N. R. Dalvi	Dr. D. G. Karpe
Dr. N. T. Dhokale	Dr. S. R. Kuchekar	Dr. Anita Deshpande

 **CHEMISTRY**  Also Available in **e-Book**



**Prashant
Publications**

© Reserved

PRACTICAL CHEMISTRY-III

S.Y.B.Sc. | Sem III | CH - 303

Publisher and Printer

Prashant Publications
3, Pratap Nagar, Shri Sant Dnyaneshwar Mandir Road,
Near Nutan Maratha College, Jalgaon 425001.

• Phone • Website • E-mail

(0257) 2235520, 2232800
www.prashantpublications.com
prashantpublication.jal@gmail.com

• First Edition • ISBN • Type Setting

August, 2020
978-93-89501-67-4
Prashant Publication

Price : ₹ 75/-

e-Books are available online at www.prashantpublications.com

 **Prashant Publications app for e-Books**

kopykitab.com • amazon.com • play.google.com

All rights reserved. No part of this publication may be reproduced, stored in a retrieval system or transmitted, in any form or by any means, electronic, mechanical, photocopying (xerox copy), recording or otherwise, without the prior permission.

ii

Contents

CH-303: CHEMISTRY PRACTICAL

A. Chemical Kinetics: Integrated rate method: (Any Three)

Experiment No. 1	7
To Study the Acid catalysed hydrolysis of an ester (methyl Acetate) and determine the rate constant (k). (first order reaction).	
Experiment No. 2	10
To compare the relative strength of HCl and H_2SO_4 or HNO_3 by studying the kinetics of hydrolysis of methyl acetate	
Experiment No. 3	13
To study the kinetics of saponification reaction between sodium hydroxide and ethyl acetate.	
Experiment No. 4	16
To determine energy of activation of the reaction between $K_2S_2O_8$ and KI.	
Experiment No. 5	20
To determine the order of the reaction with respect to $K_2S_2O_8$ by fractional life method following the kinetics of per sulphate iodide reaction.	

B. Inorganic quantitative / qualitative analysis (Any two)

Experiment No. 1	25
Estimation of Fe(III) from given solution by converting it to Fe(II) using Zn metal and then by titrating with standard solution of $K_2Cr_2O_7$ -A Green Approach.	
Experiment No. 2	29
Determination of $BaCO_3$ content in a given sample by precise determination of volume of CO_2 .	
Experiment No. 3	35
Separation and Identification of metal ions by Paper Chromatography .	

C. Organic Qualitative Analysis (Two mixtures: solid-solid type)

Experiment No. 1	39
Separation of Two Components from given binary mixture of organic compounds containing mono-functional group (Ex. - carboxylic acid, phenols, amines, amide, nitro, etc.) and systematic identification of each component qualitatively.	

D. Organic Preparations (Any two)	
Experiment No. 1	65
Preparation of benzoic acid from ethyl benzoate (Identification and confirmatory Test of -COOH group, M.P and purity by TLC) .	
Experiment No. 2	67
Acetylation of primary amine (Green approach) .	
Experiment No. 3	69
Base catalyzed Aldol condensation (Green approach)	
Practical No. 4	71
Preparation of Quinone from hydroquinone (Confirm the conversion by absence of phenolic -OH group in product, M.P and purity by TLC)	
E. pH Metry (Compulsory)	
Experiment No. 1	73
To determine equivalence point of neutralization of acetic acid by pH-metric titration with NaOH and to find best indicator for the titration.	
F. Volumetric Analysis (Any two)	
Experiment No. 1	76
Estimation of Aspirin from a given tablet and find errors in quantitative analysis. (Standardization of acid must be performed with standard Na_2CO_3 solution, prepared from dried anhydrous AR grade Na_2CO_3)	
Experiment No. 2	82
Determination of acetic acid in commercial vinegar by titrating with standard NaOH. Express your results as average \pm standard deviation. (Standardization of base must be performed with standard KHP).	
Experiment No. 1	88
. Determination of Hardness of water from given sample by complexometric titration (Using E.D.T.A.) method and total dissolve solids by conductometry. Express your results as average \pm standard deviation. (Standardization of Na_2EDTA must be performed with standard Zn(II) solution)	
• G. Mini Scale Project (Choice Based Activity)	93
• H. Students Short Activities (for both semesters)	95

43. Avkali Vilkhā: Shetkari Vednecha Hunkar

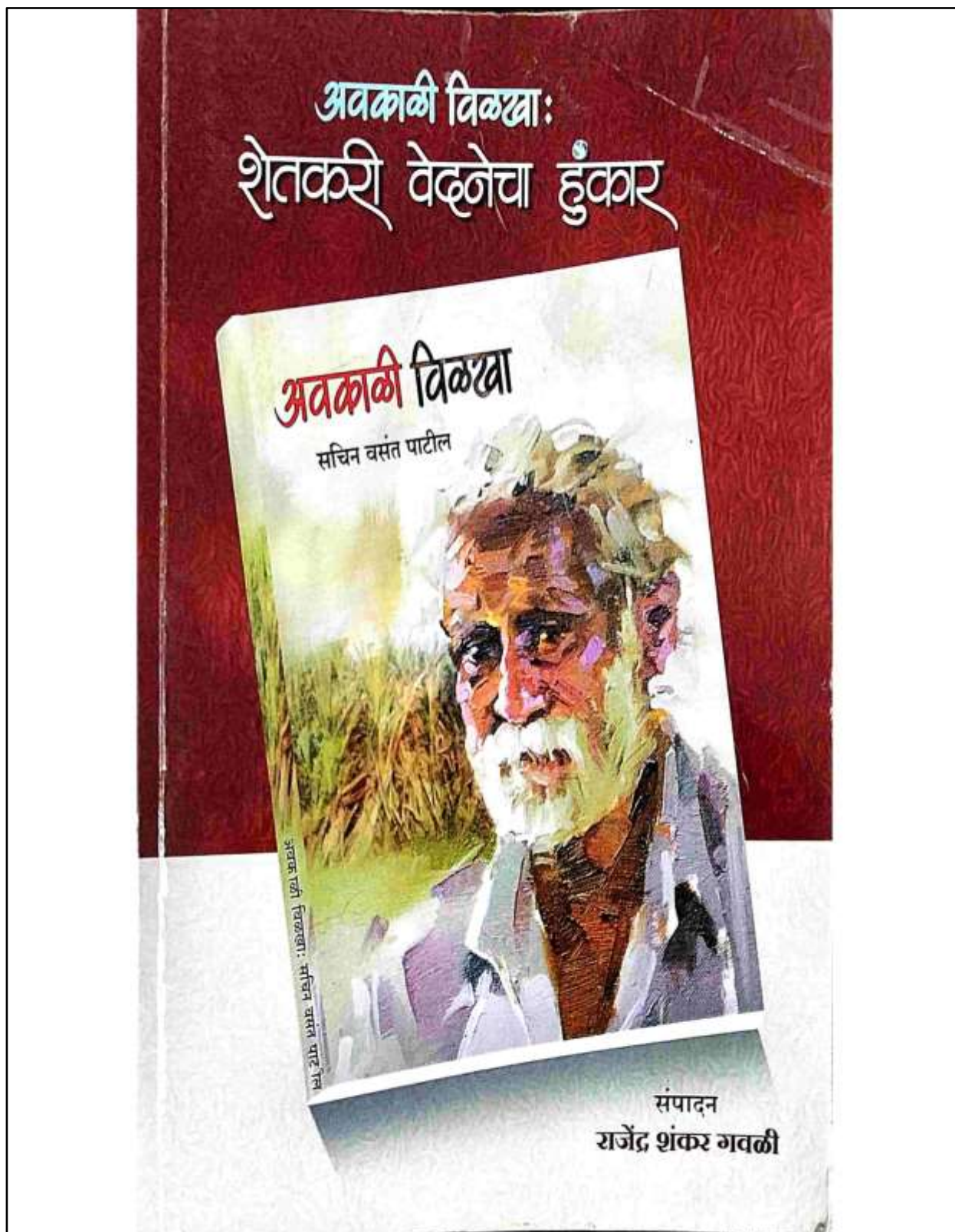

अंतरंग

- * ग्रामीण जीवनाचा वेध घेणारी कथा: अवकाळी विळखा
- उमेश मोहिते.....१५
- * ग्रामीण जीवनातील समकालीन वास्तव व समस्यांचा समग्र आढावा:
अवकाळी विळखा - डॉ. राहुल अशोक पाटील.....२०
- * अवकाळी विळखा: कृषी वेदनेचा संपन्न आविष्कार
- प्राचार्य डॉ. सयाजीराजे मोकाशी.....२७
- * ग्रामजीवनाचे वास्तव दर्शन - डॉ. द. ता. भोसले.....३२
- * मानवतेची भूमिका घेणारा कथासंग्रह: अवकाळी विळखा
- डॉ. राजेंद्र थोरात.....३४
- * अक्षरांचे अक्षय देणे: अवकाळी विळखा - सरिता पवार.....३७
- * अवकाळी विळखा: शेतकरी वेदनेचा हुंकार - हिंमत पाटील.....४२
- * वर्तुळाबाहेरील कथा: अवकाळी विळखा - रंगराव बापू पाटील.....४८
- * व्यवस्थेवर भाष्य करणारी कथा - प्राचार्य डॉ. किसन पाटील.....५१
- * ग्रामजीवनाचे वास्तव: अवकाळी विळखा - राजेंद्र भोसले.....५३
- * कष्टाची भाकरी: श्रमपतिष्ठा व ध्येयवाद जागवणारी कथा
- प्रा. डॉ. हरेश संपत शेळके.....५८
- * अवकाळी विळखा: वेदनेचा अव्यक्त हुंकार - मानसी चिटणीस.....६५
- * बळीराजाला पडलेला: अवकाळी विळखा - विजय कापडी.....६७
- * एक आश्वासक ग्रामीण कथासंग्रह: अवकाळी विळखा- संदीप नाझरे..७०
- * मातीतल्या नात्यांना सावरणारा कथासंग्रह: अवकाळी विळखा
- सुनील जवंजाळ.....७६
- * अवकाळी विळखा: एक भयाण वास्तव
- धनाजी धोंडीराम घोरपडे.....७९
- * व्यथा बळीराजाची: अवकाळी विळखा - आनंदा टक्ले.....८२

कथाची भाकरी: श्रमपतिष्ठा व ध्येयवाद जगावणारी कथा - प्रा. डॉ. हरीश संपत शेळके

प्रास्ताविक:

साधारणतः इयत्ता बारावी पर्यंत विद्यार्थ्यांना विशिष्ट लेखकांचे मर्यादित अन्वयासाठी पाठ अभ्यासासाठी असतात. या अभ्यासात भाषा, आकलन, व्याकरण या घटकांवर अधिक भर दिलेला असतो. त्यामुळे विद्यार्थ्यांना कविता, कथा, लेख यांची ओळख करून देऊन भाषेबद्दलची एक विशिष्ट अशी जाणीव विद्यार्थ्यांना घडवून यादृष्टीने साहित्याचे अभ्यास केले जाते. परंतु पुढील वर्गात जेव्हा हे विद्यार्थी येतात तेव्हा मात्र अभ्यासक्रम हा त्या विद्यार्थ्यांच्या क्षमता, आकलन, साहित्य विषयक दृष्टिकोन, समाज विषयक दृष्टिकोन, विकसित होत जावा या दृष्टीने तयार करण्यात आलेला असतो. मराठी साहित्य कथा आणि भाषिक कौशल्य विकास, एकात्मिका आणि भाषिक कौशल्य विकास हा सध्याचा अभ्यासक्रम खूप मौलिक आणि विद्यार्थ्यांच्या दृष्टीने दिशादर्शक असा आहे. या अभ्यासक्रमामुळे विद्यार्थ्यांमधील साहित्यविषयक आकलन आस्वाद आणि मूल्यमापन क्षमता विकसित होण्यासाठी मदत होणार आहे, तसेच विद्यार्थ्यांची साहित्य अभ्यासानुसार जीवनविषयक समाज विकसित होण्यासाठी मदत होईल. आजच्या माहिती तंत्रज्ञानाच्या वेगाने बदलणाऱ्या युगात आज विद्यार्थ्यांकडे विविध कौशल्य असणे आवश्यक आहे. त्यामुळे मराठी भाषेचे उपयोजनात्मक कौशल्य विकसित होण्याच्या दृष्टीनेही या अभ्यासक्रमाची रचना अतिशय चांगल्या पद्धतीने करण्यात आलेली आहे. या घटकांमध्ये आपण 'समकालीन मराठी कथा' या पुस्तकातील 'कथाची भाकरी' या कथेचा परिचय करून घेणार आहोत. या सर्व कथांमध्ये विविधता आहे. या कथा समकालीन जीवनानुभव अतिशय तीव्रपणे प्रकट करताना दिसतात. या कथांमध्ये ग्रामीण, दलित, स्त्रीवादी, आदीवासी, मुस्लिम, ग्रामीण, महानगरीय, विनोदी अशा प्रवाहातील काही निवडक कथा निवडलेल्या आहेत. त्यामुळे विद्यार्थ्यांना समकालीन मराठी कथेची ओळख होण्यास निश्चितच मदत होईल. विद्यार्थ्यांची आकलन क्षमता विकसित होण्याच्या दृष्टीने निवड केलेल्या कथा उत्तम आहेत. आता आपण सचिन पाटील यांच्या 'कथाची भाकरी' या कथेची सविस्तर ओळख करून घेणार आहोत.

लेखक परिचय:

अंबकाळी विळखा: शेतकरी वेदनेचा हुंकार | ५८

जन्म १० जुलै १९७८. मध्या पिढीतील यशस्त व महत्त्वाचे ग्रामीण कथाकार. सांगाचा, आणि अंबकाळी विळखा हे दोन कथासंग्रह प्रकाशित. साहित्य लेखनसाठी महाराष्ट्र साहित्य परिषद, इस्लामपूर शाखेचा पुरस्कार, दक्षिण महाराष्ट्र साहित्य सभा, कोल्हापूर यांचा कॉन्क खंडू पाटील पुरस्कार, महाराष्ट्र साहित्य परिषद शाखा पुणे यांचा उत्कृष्ट कथासंग्रह पुरस्कार, साहित्य साधना पुरस्कार उदगीर, अर्धशतकी पुरस्कार नागपूर, महाराष्ट्र शासन व समाज कल्याण विभाग यांच्या वतीने दिव्यांग प्रेरणा पुरस्कार इत्यादी सन्मान त्यांना लाभले आहेत. समकालीन ग्रामीण प्रश्न, विदारक वास्तव परिस्थितींवर प्रभावी भाष्य हे त्यांचे लेखन वैशिष्ट्य आहे. त्यांच्या कथा शेतकरी, कष्टकरी वर्गाची सुख दुःखे, व्यथा-वेदना, समस्यांना शब्दबद्ध करून त्यावर उपाय शोधण्याचा प्रयत्न करतात. 'कथाची भाकरी' ही कथा ग्रामीण जगाच्या वास्तवावर अतिशय तीव्रपणे भाष्य करताना दिसते. विनायक नावाच्या तरुणाची ही कथा जेव्हा आपण वाचायला लागतो, तेव्हा शेतकरी ओळ येईपर्यंत आपण ही कथा वाचताना अजिबात धांघत नाही. या कथेतील आशय त्याची केलेली मुंकरण आणि यानची जगण्यासाठी करावा लागणारा संघर्ष लेखकाने खूप चांगल्या पद्धतीने शिथिल केलेला आहे. आजच्या प्रत्येक तरुणाला ही कथा त्याचे आद्य पडविण्यासाठी निश्चितच प्रेरणादायी ठरेल.

कथेतील मुख्य पात्र: विनायक

'कथाची भाकरी' ही कथा सचिन बसंत पाटील यांच्या 'अंबकाळी विळखा' या कथासंग्रहातून घेतलेली आहे.

कथेविषयी:

समकालीन शेती, शेतकरी, कष्टकरी, मजूर या सर्वांचा विचार केला तर आपल्याला दिसून येते की, शेतीच्या परंपरागत समस्या आजही चालू आहेत. म्हणजे निसर्गाच्या भरवणावर असलेली शेती, बाजारभाव काय मिळेल हे निश्चित नाही. तेथेही अंदाज बांधत राहणे एवढेच शेतकऱ्यांच्या हातात. पतसंस्था, बँका यांचे कर्ज काढत राहणे, व्याज भरत राहणे, सतत चारा बँकांच्या ताब्यात असणे ह्या सर्व बातावरणात आजचा शेतकरी शेती करताना पिचून गेलेला दिसतो. त्याच्या आशा, अपेक्षा आकांक्षा ह्या एक तर निसर्गावर अवलंबून असतात किंवा दुसऱ्या बाजूला त्याच्या मालाला चांगला भाव मिळेल आणि त्या मिळालेल्या पैशातून त्याने पाहिलेली स्वप्न असतात. हे त्याचे विश्व असते. हाच शेतकरी वर्षानुवर्षे

अंबकाळी विळखा: शेतकरी वेदनेचा हुंकार | ५९

शेतीमाल पिकवत हजारा लोकांचा पोशिदा राहत आलेला आहे. 'कष्टाची भाकती' या कथेत विनायक या तरुण शेतकऱ्याची व्यथा अत्यंत संवेदनशीलपणे लेखकाने रेखाटलेली आहे. खरं तर समकालीन समाज जीवनात विनायक हे प्रातिनिधिक उदाहरण आहे. आज अनेक शेतकऱ्यांची हीच अवस्था आहे. त्यामुळे समकालीन शेतीची अवस्था, शेतकऱ्यांची दुरवस्था ताकदीने चित्रित करण्यात लेखक यशस्वी ठरलेला आहे.

विनायक नावाचा तरुण शेतकरी. द्राक्षाचे चांगले उत्पादन होईल व पैसाही भरपूर मिळेल या आशेवर त्याने द्राक्षबागेची लागवड केलेली असते. परंतु सलग दोन-तीन वर्षांपासून पडणाऱ्या रोगानं, अवकाळी पावसानं द्राक्ष बागेचं प्रचंड नुकसान होतं. तर त्याच्यावर असलेलं कर्ज एका बाजूला वाढतच राहतं. आता मात्र त्याच्या पाठीमागे बँकेने तगादा लावला. कर्ज कसे फेडावचे या विचारात तो असतो. तेवढ्यात बँकेने जमीची नोंटीस काढली म्हणून विनायकने शेती चुलत्याला गहाण द्यायची, असं ठरवलं. बारा वर्षे व्याज म्हणून चुलत चुलत्यानं रान खावचं, असं ठरलं. त्याने बँकेकडून स्वतःची मुटका करून घेतली. आता पुढे काय? हा प्रश्न त्याच्यासमोर होता. कारण विनायक हा बी. कॉम. झालेला असतो. त्यामुळे रोजंदारीवर कामाला जायची त्याला लाज वाटते. म्हणून तो नोकरी करायची ठरवतो. नोकरीसाठी तो खूप प्रयत्न करतो. परंतु यश मात्र येत नाही. नोकरीसाठी वगवग फिरून शेवटी हताश होऊन तो घरी परतत असतो. या सर्व अवस्थेत त्याला व्यसन जडते. तो आकडा हा जुगाराचा प्रकार खेळू लागतो. आणि हळूहळू तो या आकड्याच्या खेळात पाण्यासारखा वाहत जातो. त्याला कशाचेच भान राहत नाही. तो या आकड्याच्या नादात आपले सर्वस्व गमावतो. एके दिवशी पत्नीचे दागिने तो या आकड्यावर लावतो. आता आपण प्रचंड श्रीमंत होऊ, असं त्याला वाटतं. त्या रात्री तो स्वप्नांच्या दुनियेत झोपून जातो. सकाळी उठल्याबरोबर तो आकड्याच्या निकाल पाहण्यासाठी गेला तर तो सपशेल हरलेला असतो! त्याचे सर्व पैसे बुडालेले असतात. तो आतून-बाहेरून प्रचंड हादरून गेलेला असतो. त्याला काहीच सुचत नाही. पायाखालची जमीन सरकून गेलेली. आता आपण आपल्या बायको-मुलांना तोंड कसं दाखवायचं? हा प्रश्न त्याला पडलेला असतो. त्यामुळे या सर्व परिस्थितीत तो स्वतःला संपवण्याचा विचार करतो! परंतु आत्महत्या करण्यासाठी रेल्वे रुळावर पडला असताना एका क्षणी त्याला आपली लहान मुले आठवतात, बायको

अवकाळी विळखा: शेतकरी वेदनेचा हुंकार । ६०

आठवते आणि आपल्यानंतर त्यांचे काय? या विचाराने तो तडकच उठून पुन्हा आपल्या घराच्या दिशेने चालू लागतो. सकाळी लवकर उठतो, भाळ्यावर पडलेलं खोरं हुडकून काढतो. आंघोळ करताना ते पाण्याने स्वच्छ धुऊन काढतो. गवंड्याच्या हाताखाली कामाला जायचे ठरवतो. आता त्याने निवडलेला मार्ग कष्टाचा असतो. काट्याकुट्यातून जाणारा असतो पण घामाचे मोती करणारा असतो. त्याला वाटत होतं, लोकं हिणवतील, हसतील पण इमानदारीने राबणाऱ्या हलांना भौती कोणाची? असा तो सकारात्मक विचार करतो.

खांद्यावर खोरं टाकून तो नाना गवंड्याच्या घराकडे चालू लागतो. कारण आता त्याला कष्टाच्या भाकतीची चव चाखायची असते. त्याच्यातल्या या बदलामुळे घरातील घातावरण आनंददायी झाले होते. अशा प्रकारे लेखकाने सकारात्मक रंगवत ही कथा शेवटच्या क्षणी एका विशिष्ट उंचीवर नेऊन पोहोचवली आहे. ही कथा वाचनीय तर आहेच तसेच आपल्या प्रत्येकाला विचार प्रवृत्त करायला लावणारी सुद्धा आहे.

ग्रामीण वास्तवाचा परखड वेध घेणारी कथा:

१९७५ नंतरच्या ग्रामीण कथेतून रा. रं. बोरडे, आमंद वादव, रणजित देसाई, भास्कर चंदनशिव, नागनाथ कोतापडे, चारुता सागर, आमंद पाटील, प्रतिभा इंगोले, सदानंद देशमुख, आसाराम लोमटे इत्यादी व अशा इतर अनेक कथाकारांनी ग्रामजीवनाच्या विविध पैलूंचे दर्शन घडवले आहे. ग्रामीण जीवनातील शोषणाच्या विविध परी या लेखकांनी व्यक्त केल्या आहेत. वासंदर्भात ग्रामीण जीवनातील तीव्र असलेल्या जातिभेद, स्त्री-पुरुष विषमता यांचे थेट चित्रण या लेखनात येते. त्याचबरोबर ग्रामीण जीवनात वसलेले शहर आणि तकलादू आधुनिकता, निसर्गावर अवलंबून असलेली शेती, शिकलेल्या तरुणाची ससेहोलपट अशी काही नवी आशयसूत्रे या काळातील ग्रामीण कथेत आढळतात. बदलत्या ग्रामीण जीवनाचे तटस्थपणे आकलन करणारा निवेदक या कथांमधून आढळतो.

अलीकडच्या काळातील सचिन पाटील हे ग्रामीण साहित्यातील एक दमदार नवे लेखक म्हणून नावारूपाला येत आहेत. त्यांनी त्यांच्या 'अवकाळी विळखा' या कथासंग्रहातील 'कष्टाची भाकती' या कथेत ग्रामजीवनातील एका नवतरुणाची शेतीतून पीक घेऊन चांगले पैसे मिळवून आयुष्य बदलण्याचे स्वप्न पाहणाऱ्या तरुणाची व्यथा जिवंतपणे चित्रित केलेली आहे. या कथेतून आपल्याला ग्रामजीवनातील

अवकाळी विळखा: शेतकरी वेदनेचा हुंकार । ६१

नवीन स्वरूपा, प्रश्न यांची ओळख होते. तसेच आजच्या गावगाड्यातील बदललेल्या वास्तव वा वास्तववादीच्या खेड्यातील माणसाचे बदलणारे स्वभाव, बदलणारा खेड्यातील वा सर्व गोष्टींकडे बघताना तेवढ्या लेखकांनी शेतकरी अस्तित्वाची मानवी जीवनाची मूल्ये, तसेच शेतकरी अवलंबून असलेला शेतकरी, त्याची सुख, दु:ख आणि तो पाहून असलेली स्पर्धा अत्यंत प्रत्यक्षरी रीतीने चित्रित केलेली आहेत. १९९० च्या दशकात ग्रामीण, शहरी जीवनात झपाट्याने बदल होत गेले आहेत. या दशकात जागतिकीकरण, होममालाचे धाव, एकाधिकार आणि शेतकऱ्यांच्या आत्महत्येचा वाढी बऱ्याही स्वरूपात झालेली आपल्याला दिसू येते. ग्रामीण जीवन आणि या जीवनातील पुढागुरू उलटतानाच बांगल कर्तव्य १९७५ नंतरच्या ग्रामीण कथा लेखकांनी केलेले आपल्याला दिसू येते. ग्रामीण जीवनातील प्रत्यक्ष अनुभूती या कथाकारांनी समर्थन देऊन दिलेली दिसते. या कथाकारांनी ग्रामजीवनातील समस्यांमध्ये असलेल्या विविध गुंतणुतीचे चित्र आपल्या कथांमधून केलेले दिसून येते. म्हणूनच सधिल्या पाठीत बारी 'कथाची भाकरी' या कथेतून ग्रामजीवनातील वा वास्तवावर परखडपणे भाष्य केले आहे. ते सर्वाना विचार करायला प्रवृत्त करणारे आणि एकूणच आजच्या ग्रामीण वास्तवाला नवी दिशा दाखवणारे आहे.

कथाची वैशिष्ट्ये:

'कथाची भाकरी' या कथेची वैशिष्ट्ये पुढीलप्रमाणे आपल्याला सांगता येतील.

१. कथाची भाकरी ही कथा भ्रमप्रतिष्ठा आणि ध्येयवाद जागवणारी व प्रेरणा कथा आहे.
२. ध्येय, दारिद्र्य, कर्जबाजारीपणा, दु:ख, शोषण, निराशा यावर भ्रम, धम्म आणि ध्येयवादने मात करता येत हा संदेश ही कथा आपल्याला देते.
३. पारंपरिक असो वा आधुनिक शेती असो बदलते अर्थकारण, अस्माना व सुलतानी संकटे, यामुळे शेतकऱ्यांची उपेक्षा संपत नाही. अशा परिस्थितीत आत्मभान बगे ठेवून भ्रम वा मूल्याचा दीप प्रज्वलित केल्यास जगण्याचा मार्ग सापडतो, असा संदेश ही कथा देते.
४. या घटनाग्रधान कथेचे प्रवाही कथानक, अर्धपूर्ण शेवट आणि ग्रामीण शैलीमुळे कथेला उंची प्राप्त होते.
५. कथाची भाकरी हे मूल्य अतिशय प्रत्यक्षकारी रीतीने ही कथा वाचकांसमोर उभे करते.

अवकाळी विळखा: शेतकरी वेदनेचा हुंकार । ६२

६. विनायकचा संघर्ष, हातबलता, निराशा आणि शेवटी विनायकचे त्याचे स्वतःच्या कष्टातून मिळविलेला विजय, हे सर्व वाचकांला प्रचंड ऊर्जा देणारे उभे आहे.

७. जगण्याकडे सकारात्मक वृत्तीने कसे बघायला हवे याचे उत्तम उदाहरण ही कथा आहे.

८. आजच्या वास्तव जगण्याला ही कथा सहजपणे मिळविलेली दिसते.

९. ही कथा आजच्या तरुणांसमोर एक आदर्श उदाहरण म्हणून विविध सांगता येईल.

१०. बदलते अर्थकारण आणि शेतकऱ्यांचे जगणे, त्यांच्या घटणांना असलेले दु:ख, त्या दु:खाला वाचा फोडणारी एक ज्वलंत शब्दबद्ध कथा म्हणून कथाचा भाकरीचा उद्देश आपल्याला करावाच लागेल.

सांश्लः समकालीन शेती व त्या संदर्भात असणारे प्रश्न, शेतकरी व त्यांच्या जगण्याचा संघर्ष, त्याला संकटांचा करावा लागणारा सामना या सर्व गोष्टींवर मार्मिक भाष्य करताना ही कथा दिसते. विनायकचा संघर्ष हा प्रातिनिधिक आहे. परंतु आपल्या अखती-भोवती समाजात जेव्हा आपण बाहेर डोक्याकरी तेव्हा विनायक सारखे संकट स्वतःवर आलेले अनेक शेतकरी आपण पाहतो. खरं तर शेतकऱ्यांच्या आशा, अपेक्षा आणि आकांक्षा या सर्व निसर्गावर आणि शेतीतून मिळणाऱ्या उत्पादनावर अवलंबून असतात. आयुष्यभर तो शेतकरी अहोरात्र कष्ट असतो. परिस्थितीही झपाटत असतो.

'कथाची भाकरी' या कथेतून एका बाजूला विनायकचा संघर्ष, त्याची हातबलता, पराभव हे सर्व चित्रित होतांना दिसते. त्यावेळी वाचक विनायकवद्दल संवेदनशील होत जातो. परंतु लगेच दुसऱ्या बाजूला विनायकने त्या प्रतिकूल परिस्थितीवर केलेली मात, जगण्यासाठी निवडलेला कष्टाचा मार्ग वाचकाची उभेत वाढवणारा आहे. म्हणूनच ही कथा एका अधीन जीवना जगण्याची प्रेरणा देणारी कथा आहे.

महत्त्वाचे शब्द व त्यांचे अर्थ:

भोक्यात: महात्वाच्या वेळी, दावण्या: द्राक्ष बागेबरील रोग, काढणी: द्राक्षांची तोडणी/ पिकांची कापणी, अवकाळी पाऊस: अवांनक/ गैरहंगामी वेणार पाऊस, आंदर बट्ट्यात: तोड्यात, च्याथरस: आजार/ विषाणूजन्य रोग, बोकांडी: छर्चाचा बोजा अंगावर बसणे, अग्नीचक्रात: सतत संकटात, होरपळ: दु:ख-वेदना-उपासमार,

अवकाळी विळखा: शेतकरी वेदनेचा हुंकार । ६३

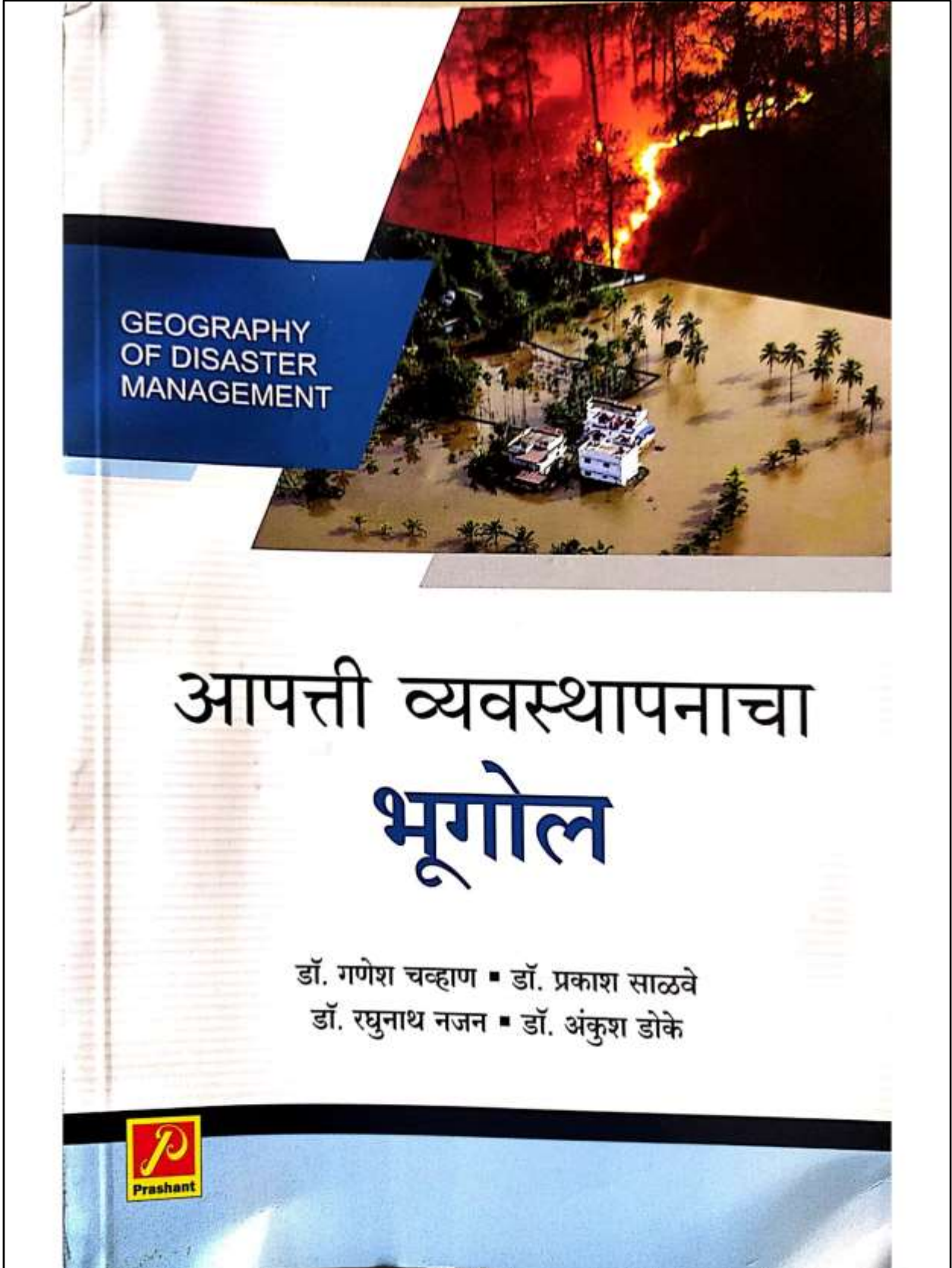
44. Geography of Disaster Management

'आपत्ती व्यवस्थापनाचा भूगोल' या ग्रंथात आपत्ती व्यवस्थापनातील संकल्पना, आपत्ती आणि संकट : ओळख, आपत्ती व्यवस्थापन आणि उपाययोजना, हवामानविषयक आपत्ती आणि व्यवस्थापन, भूगर्भीय व भूरूपशास्त्रीय आपत्ती आणि व्यवस्थापन, मानवनिर्मित आपत्ती आणि व्यवस्थापन, जागतिक समस्यांचा अभ्यास, आपत्ती घटनांचा अभ्यास या विविध घटकांची विस्तृत माहिती दिली आहे. पर्यावरणीय संकल्पनांचे आकलन सुलभ व्हावे म्हणून विविध आकृत्या, नवीन संकल्पना, तक्ते, नवीन संज्ञा सदर पुस्तकात अत्यंत सोप्या व सुलभ भाषेत मांडण्याचा प्रामाणिक प्रयत्न केला आहे. त्यासाठी वेगवेगळी संदर्भ ग्रंथ, नियतकालिके, इंटरनेटवरील माहिती, वृत्तपत्रीय कात्रणे इत्यादींचा वापर केला आहे. सदरचे पुस्तक सद्यकालीन पर्यावरणीय घटकांवर आधारित असल्याने विविध स्पर्धात्मक परीक्षांना तसेच नेट/सेट परीक्षांनाही उपयोगी ठरेल असा प्रयत्न आहे.

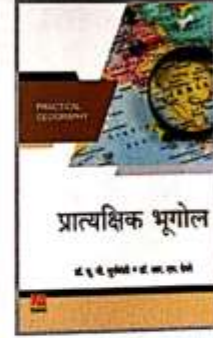
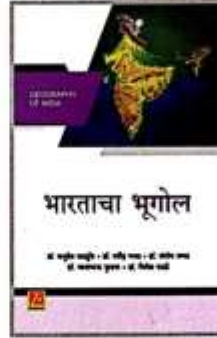
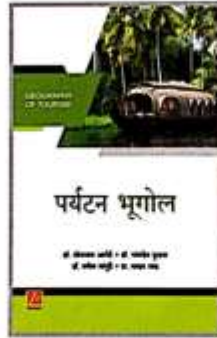
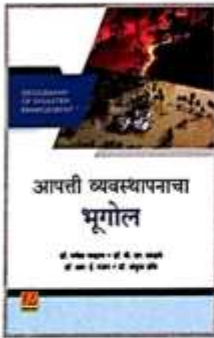

Also Available in
e-Book



भूगोल

₹ 245

ISBN 978-93-91391-65-2



9 789391 391652

www.prashantpublications.com
prashantpublication.jal@gmail.com

45. Bhartcha Bhugol

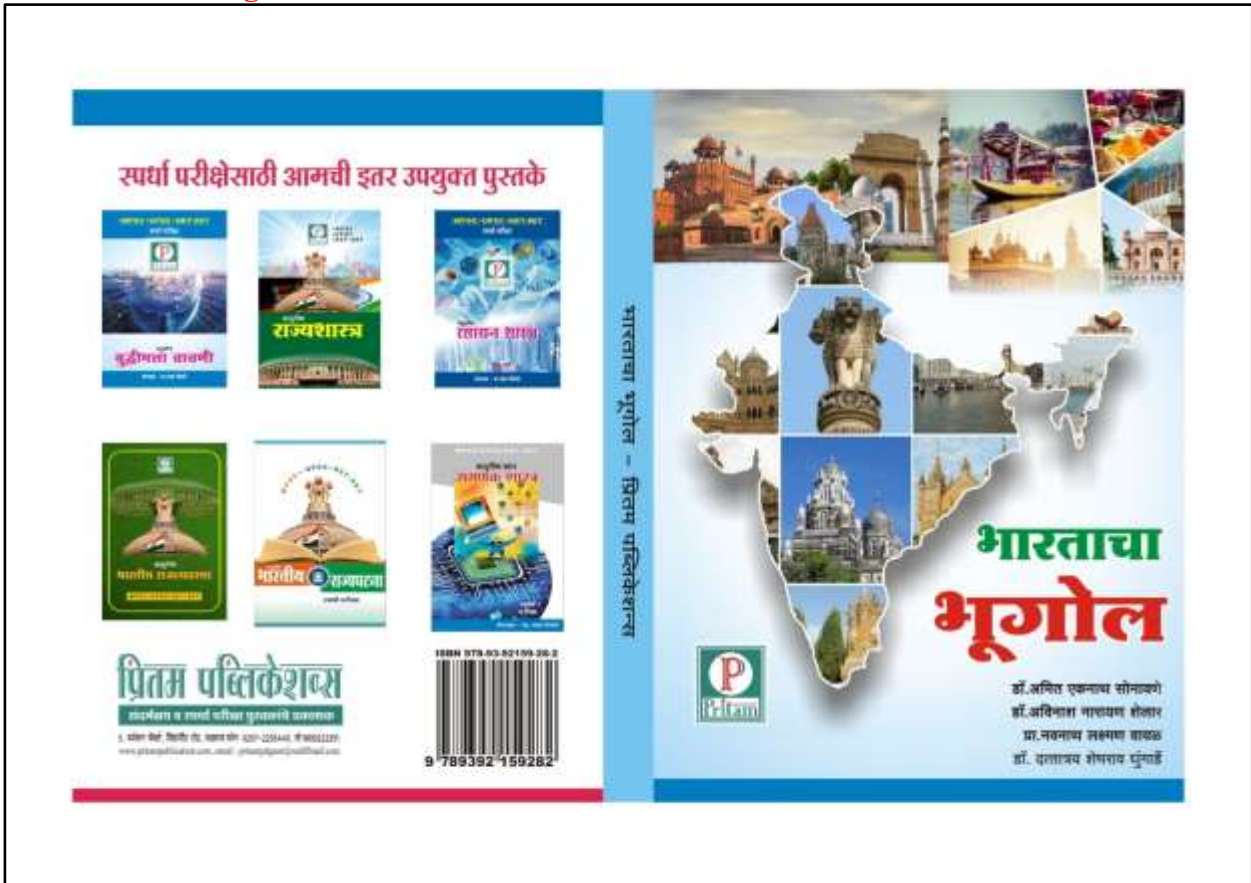

46. Bhartcha Bhugol

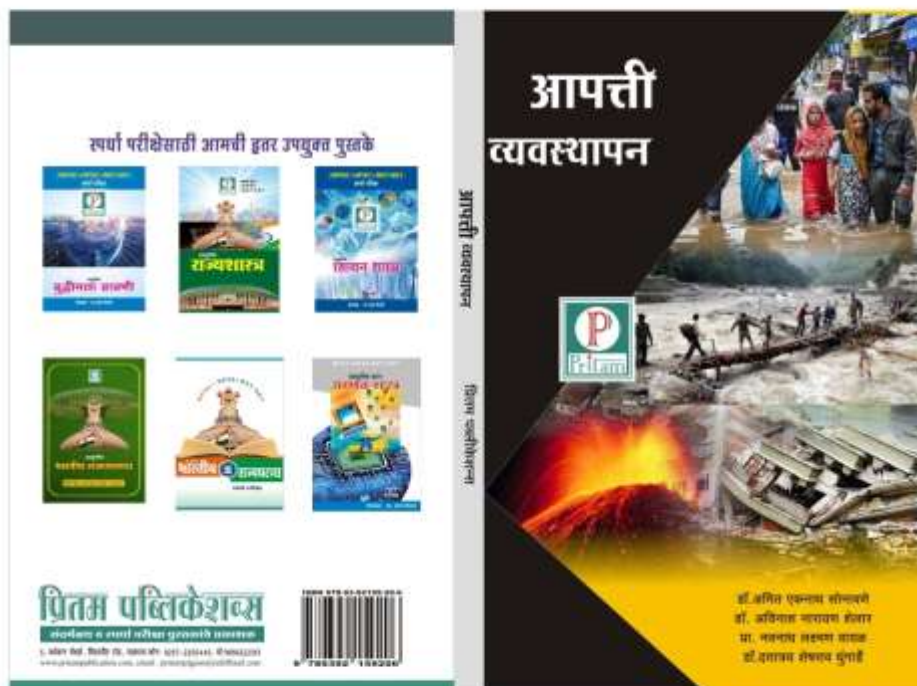

47. Gramin Vikasacha Bhugol

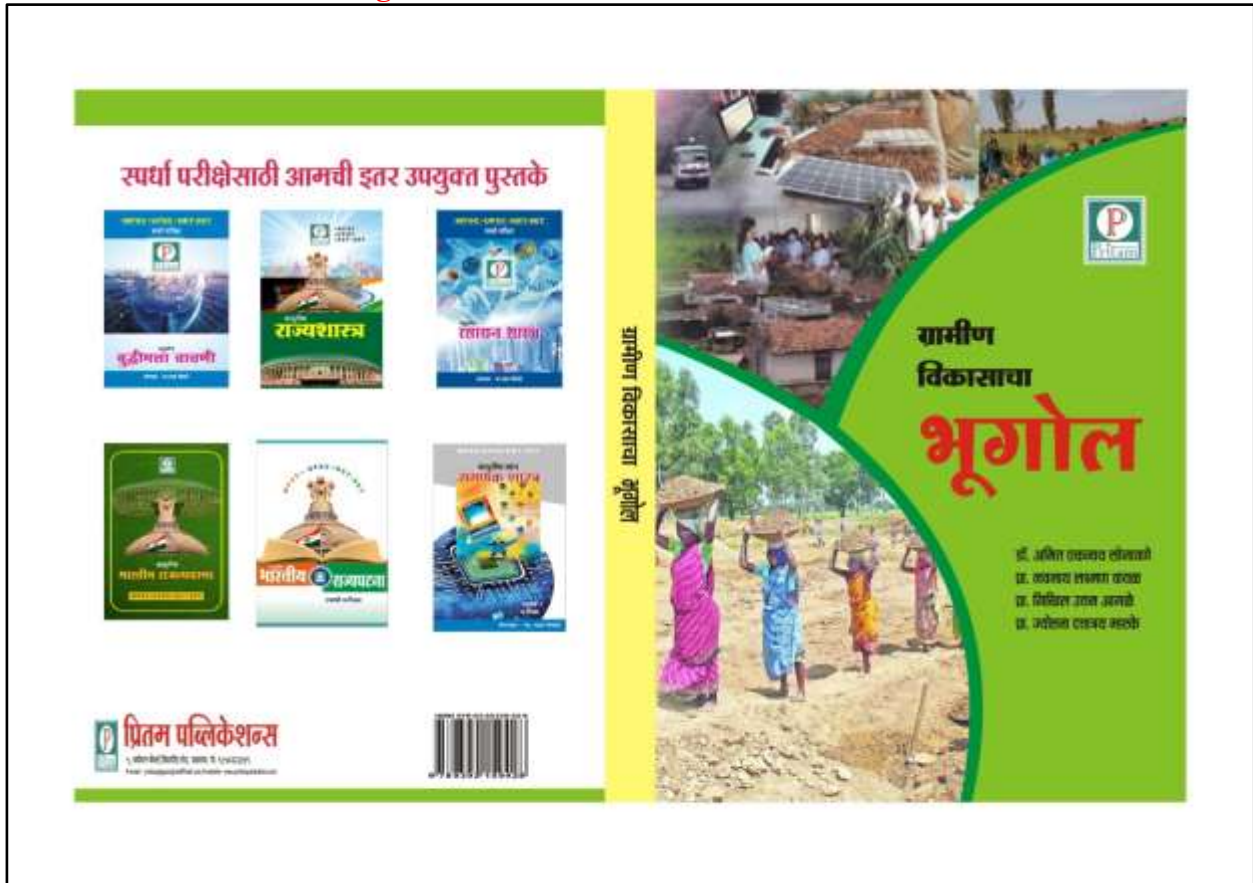

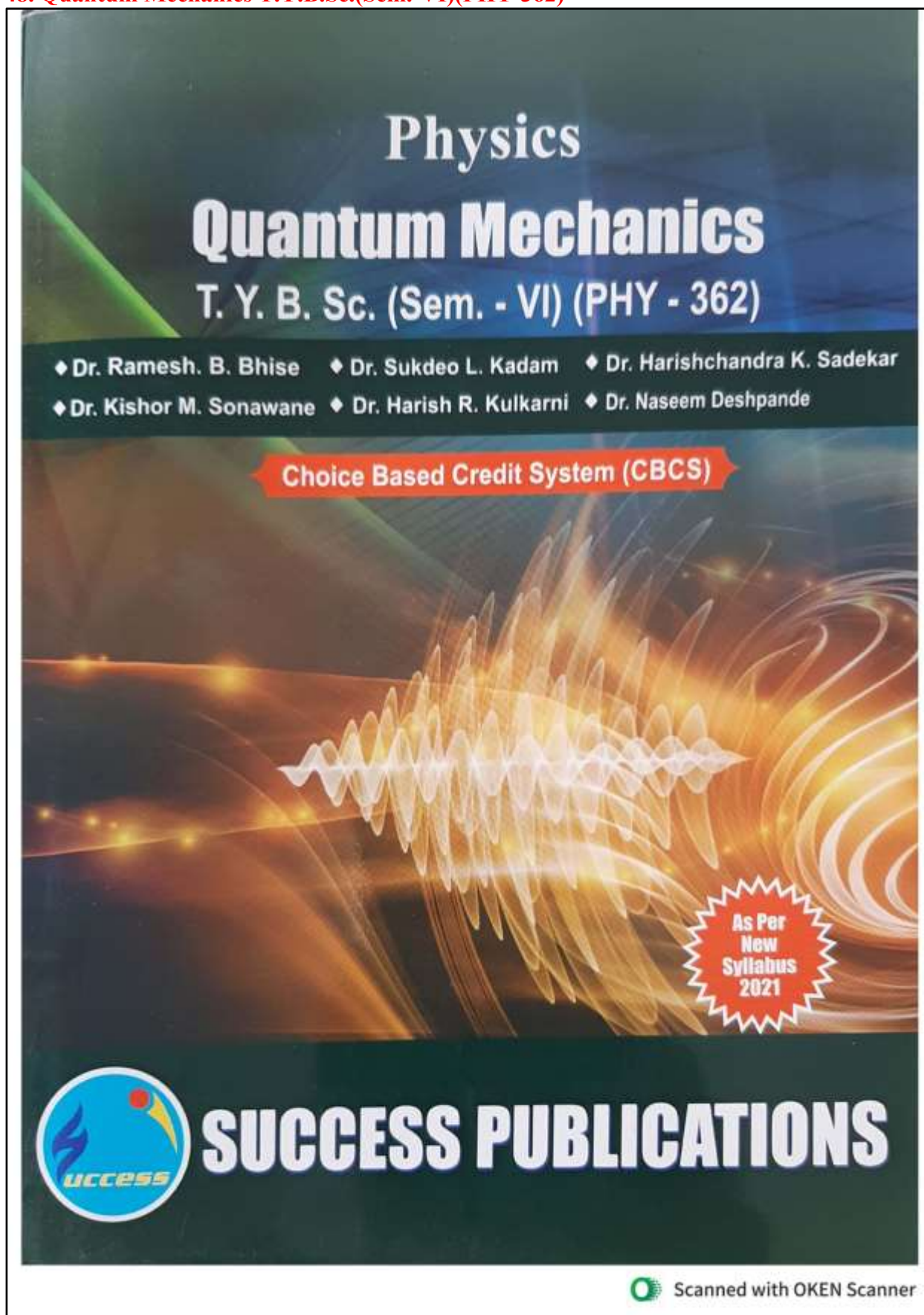
48. Quantum Mechanics T.Y.B.Sc.(Sem.-VI)(PHY-362)



ISBN : 978-93-24457-54-1



SUCCESS PUBLICATIONS

Address : Radha Krishna Apartment, 535, Shaniwar Peth,
 Appa Balwant Chowk, Opp. Prabhat Theatre, Pune - 30.
 Ph. No. 24434662, Mobile : 9325315464
 E-mail : sharpgroup31@rediffmail.com
 Website : www.sharpmultinational.com

PT-3616

Scanned with OKEN Scanner

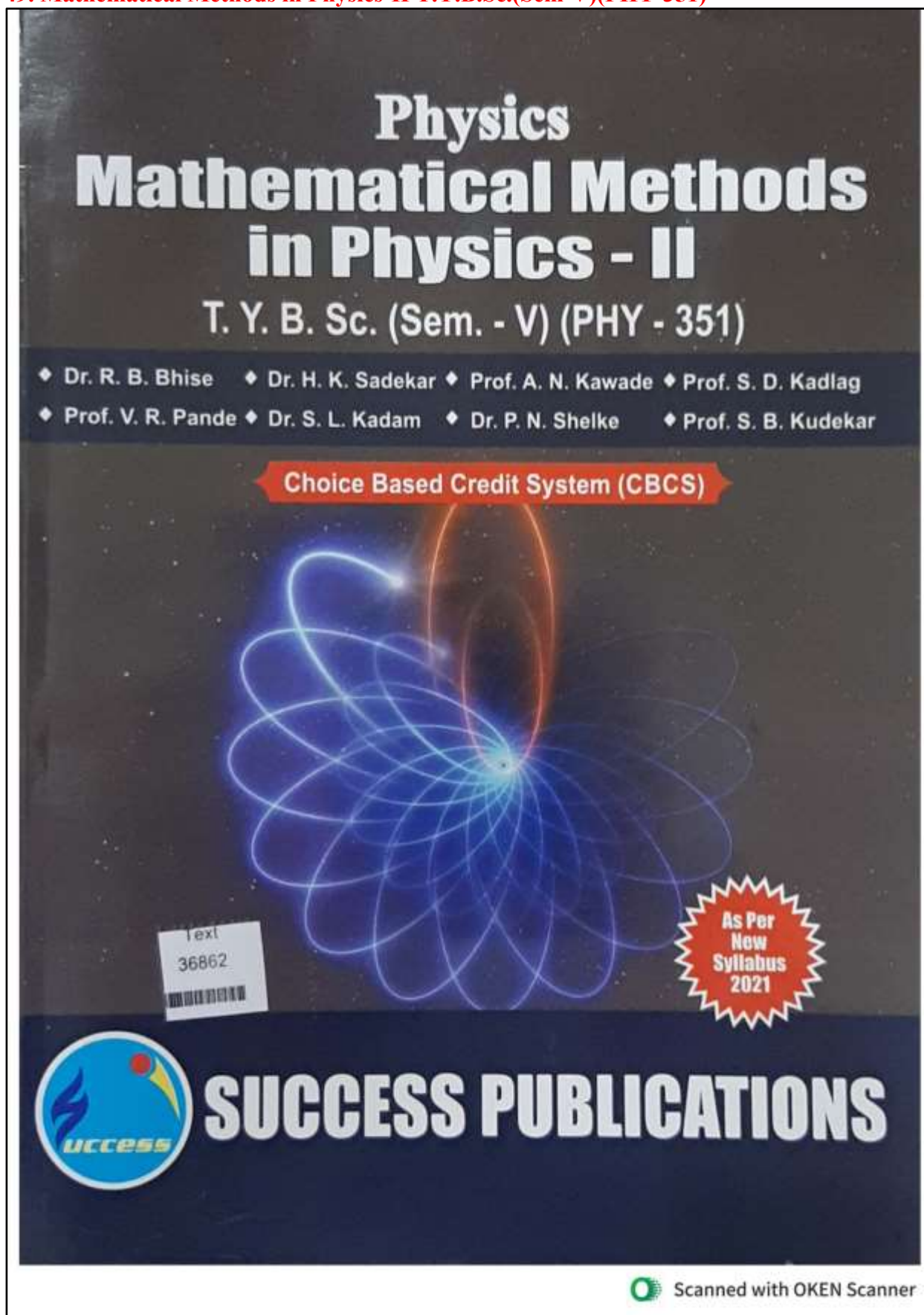
49. Mathematical Methods in Physics-II T.Y.B.Sc.(Sem-V)(PHY-351)

The image displays six book covers from Success Publications, arranged in two rows of three. Each cover features a central illustration related to its subject matter and includes the publisher's logo and name at the bottom.

- Classical Mechanics:** Physics, T. Y. B. Sc. (Sem. - V) (PHY - 311). Illustration: Pendulums.
- Electrodynamics:** Physics, T. Y. B. Sc. (Sem. - V) (PHY - 312). Illustration: Electric field lines.
- Renewable Energy Sources - I:** Physics, T. Y. B. Sc. (Sem. - V) (PHY - 313 (II)). Illustration: Wind turbines and solar panels.
- Elements of Material Science:** Physics, T. Y. B. Sc. (Sem. - V) (PHY - 314 (II)). Illustration: Molecular structure.
- Computational Physics:** Physics, T. Y. B. Sc. (Sem. - V) (PHY - 315). Illustration: Digital data flow.
- Atomic and Molecular Physics:** Physics, T. Y. B. Sc. (Sem. - V) (PHY - 316). Illustration: Atomic model and Bohr's orbits.

Success Publications
 Address : Radha Krishna Apartment, 535, Shaniwar Peth, Appa Balwant Chowk, Opp. Prabhat Theatre, Pune - 30.
 Ph. No. 24434662, Mobile : 9325315464
 E-mail : sharpgroup31@rediffmail.com
 Website : www.sharpmultinational.com

ISBN : 978-93-24457-44-7

PT-3578

50. Biodiversity (Fungal Biofertilizer)

viii // Biodiversity and Sustainable Resource Management...	
10. Fungal Biofertilizer: Mycorrhiza Dr. Rangnath Aher	120-136
11. Wild Life Tourism in India and its Ecological Benefits Dr. Rajani Gautam	137-158
12. National Biodiversity Authority: Guidance and Understanding Dr. Bireshwar Bera	159-173
13. Avifaunal Diversity and Its Current Status in Terai Region of West Bengal Debarshi Bhattacharyya & Subhasish Kundu	174-178
14. Multipurpose Uses of Sericulture for Upliftment of Livelihood in Rural Areas Biswa Ranjan Goswami, Narayan Chandra Saha & Joy Krishna De	179-187
15. Biodiversity Loss and Natural Environment: Causes, Consequences and Mitigation of problems Dr. Debabrata Das	188-207
16. Arbuscular Mycorrhizal Study: A General Guideline to Beginners Pampi Ghosh	208-218
17. Ethno Zoology and Ethno Botany in Exploring Folk Culture through Ages Balaknath Bhattacharyya	219-257
18. A Review on Medicinal Plants Associated with Joychandi Hill, Purulia District, West Bengal Dr. Sujit Kumar Mandal, Suparna Roy & Sudeshna Mukherjee	258-271



Biodiversity is the diversity of species, gene and ecosystem in connection with physiognomic factors and their interactions. It includes local or global flora, fauna and microbes in a small scale or large habitat basis. Due to various threats on the environment, biodiversity is under threat and signalling the overall ecosystem loss. Conservation of biodiversity is a popular issue in the present day scenario of managing the environment. It includes overall health of the ecosystem, even sustenance of life on earth. It also reflects the economic growth of a nation that globally determines the healthy and wealthy environment. Various measures may be taken from various sites to protect our resources and also for our sustenance. Chapters of the book highlight the present status and conservation strategies of total biodiversity including natural resource management on a global area basis.

About the Editor



Dr. Debabrata Das (b.1969) Ph.D. in Botany (Plant Ecology) from Vidyasagar University, Midnapore, West Bengal is presently working as Associate Professor of Botany and Head, Department of Botany, Government General Degree College, Lalgargh at Binpur-I, Lalgargh, Jhargram, W.B. He acted as IQAC Co-ordinator of the same College and acted as Govt. officer since 2002 under West Bengal Educational Service (W.B.E.S). He is a pioneer researcher in the College and also this lateritic Southwest Bengal zone. He was a research fellow (JRF and SRF) of forest productivity project funded by ICFRE, Dehradun and done his work at southwest Bengal forests from 'Centre for Natural Studies (CNS)' at Raja N.L.Khan Women's College, Midnapore, W.B. Later on he worked as JRF and SRF at Central National Herbarium (CNH), Botanical Survey of India (BSI), Shibpore, Howrah, W.B. under 'Flora India Project'. He has worked in various Medicinal Plants Conservation Areas (MPCAs) as expert with his team at Eastern Himalayan part, Dooars and in South Bengal (Susunia Hills) of W.B. He has authored more than 100 scientific research papers and 4 books in Environmental studies and in Botany. He has worked as technical advisors to many scientific national and international journals. Now he is a coordinator of a series of lectures (online) and conferences of many national and international kinds. He also acted as co-ordinators of National and International conferences conducted by various organizations during Covid-19 and during new normal.



Bharti Publications, New Delhi

E-mail: bhartipublications@gmail.com, info@bhartipublications.com,
www.bhartipublications.com

978-93-91681-79-1



Price- Rs. 1180/-

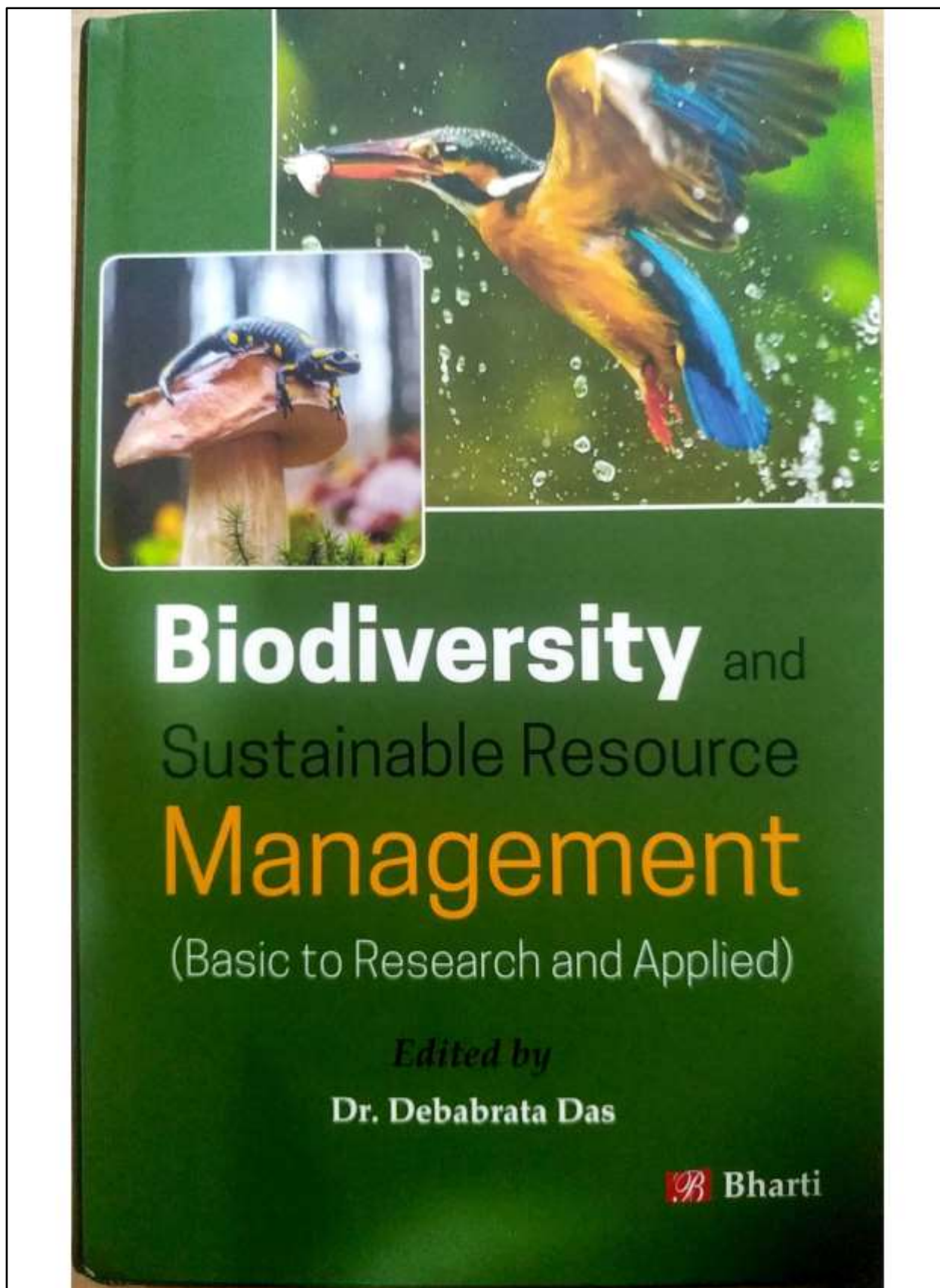

51. Applied Research in Botany Volume-1**APPLIED RESEARCH IN
BOTANY VOLUME-1**

Dr. Anil Laxman Bhalerao
[M.Sc. Ph.D.]

Dr. Rajesh Shirangrao Gaikwad
[M.Sc. Ph.D.]

mp mahi
Publication

ISBN: 978-93-90651-59-7

First Edition: 2021

This book is sold subject to the condition that it shall not, by way of trade or otherwise, be lent, resold, hired out, or otherwise circulated without the publisher's prior written consent in any form of binding or cover other than that in which it is published and without a similar condition including this condition being imposed on the subsequent purchaser and without limiting the rights under copyright reserved above, no part of this publication may be reproduced, stored in or introduced into a retrieval system, or transmitted in any form or by any means (electronic, mechanical, photocopying or recording) otherwise without the prior written permission of both the copyright owner and the above-mentioned publisher of this book.

PRICE ₹ 399/-

PUBLISHER
MAHI PUBLICATION

 Office No.1, Krishnasagar Society, Nr. Shivsagar sharda Mandir Road,
Ahmedabad-380007

 mahibookpublication@gmail.com

 +(91) 798 422 6340

 www.mahipublication.com

Copyright © 2021\ MAHI PUBLICATION

Dedicated to

Our Esteemed Teachers

Dr. D. S. Mukadam

Ex. Professor and Head

Department of Botany,

Dr. Babasaheb Ambedkar Marathwada University,

Aurangabad.431004 (M.S) India.

.....

Dr. V. S. Kothekar

Ex. Professor and Head

Department of Botany,

Dr. Babasaheb Ambedkar Marathwada University,

Aurangabad.431004 (M.S) India.

SR. NO.	TITLE OF THE RESEARCH PAPER	NAME OF AUTHOR	PAGE NO.
1	EFFICIENCY OF MYCORRHIZAE AND PGPF FOR GROWTH PERFORMANCE ON CHILI CV SITARA	PROF. DR. UDHAV N. BHALE	9
2	EFFECT OF MYCORRHIZA ON CHEMICAL COMPOSITION OF THE <i>TAJETES ERECTA</i> , L AND <i>CATHARANTHUS ROSEUS</i> , L	PRINCIPAL DR. RANGNATH AHER	19
3	EXPLORATION OF EMERGENCY HERBAL FOOD RESOURCES OF TRIBAL PEOPLE FROM THE RAIGAD DISTRICT OF THE MAHARASHTRA STATE, INDIA.	DR. KALPIT MHATRE AND PRINCIPAL DR. RAJENDRA SHINDE	25
4	EFFECT OF GA+ IAA AND GA+ NAA PRE-TREATMENTS ON SEED GERMINABILITY AND ROOTING OF STEM CUTTINGS OF JATROPHA SPECIES.	DR. RAJESH SHRIRANGRAO GAIKWAD	29
5	GENETICALLY MODIFIED DISEASE RESISTANT FRENCH BEANS (<i>PHASEOLUS VULGARIS</i> L.) AS AN IMMUNE BOOSTER- A REVIEW	SHREYA DOGRA & NARAYAN TOTEWAD	37
6	EFFECT OF PEG-6000 INDUCED WATER STRESS ON PHYTOCHEMICALS IN WHEAT CULTIVARS (<i>TRITICUM AESTIVUM</i> L.)	DR. DESHMUKH R.N. & SAWANT K.S.	48
7	COMPARATIVE STUDY ON DIFFERENT CLEARING METHODS FOR THE PREPARATION OF LEAF VENATION OF LEAVES.	SAIMA RASHID MIR, B.M. SHINDE AND M.M JANA	55
8	ETHNOMEDICINAL PLANTS USED BY KOKNI TRIBAL OF NASIK AND DHULE DISTRICTS FOR TREATMENT OF PILES (MAHARASHTRA)	SACHIN D. KUVAR AND DR. RAJENDRA D. SHINDE	60
9	EFFECT OF MEDICINAL PLANTS ON PATHOGENIC FUNGI	RAFI AHMED, SACHIN CHAVAN AND RUKHSAR BANO ANSARI	66
10	ADDITION OF SACRED GROVE FROM RAIGAD DISTRICT FOR THE STATE OF MAHARASHTRA	DR. KALPIT MHATRE	75
11	EFFECT OF NITROGENOUS WASTE WATER OF BUFFALO STABLE ON GROWTH PARAMETERS OF SOME VEGETABLES IN MUMBAI	NISHA SUTAR AND ANIL BHALERAO	82
12	FLORISTIC DIVERSITY OF PLATEAUS IN DEVGAD, SINDHUDURG, MAHARASHTRA AND NEED FOR THEIR CONSERVATION	DR. ALOK GUDE AND KALPIT MHATRE	95

Applied research in Botany Volume-1

13	USE OF NATURAL FLORAL EXTRACTS AS PH INDICATORS	ANKIT YADAV, NIKUNJ SULE AND PRATIKSHA KARADE	97
14	FUNGAL CONTAMINATION OF PAPER CURRENCY POSSESSED BY DIFFERENT OCCUPATIONERS AND ITS CONTROL	DR. RAJENDRA B. KAKDE	103
15	EFFECT OF NITROGENOUS WASTE WATER OF BUFFALO STABLE ON NUTRIENTS OF SOME VEGETABLES	NISHA SUTAR AND ANIL BHALERAO	111
16	OCCURRENCE OF AM FUNGI IN <i>CASSIA TORA L.</i> PLANTS OF OSMANABAD DISTRICT	PRAKASH SARWADE, SHAHAJI S. CHANDANSHIVE, VIKAS P.SARWADE AND KAVITA N. GAISAMUDRE	118
17	EFFECT OF COOKING AND STORAGE CONDITIONS ON THE NUTRITIVE VALUE OF <i>DOLICHOS</i> BEANS,	SURVE SHIVANI A. AND BHAGAT SACHIN S.	123
18	STUDY OF SEASONAL VARIATION IN LEAF CHLOROPHYLL CONTENT OF SOME TREE SPECIES OF HINGOLI REGION (M.S.)	DR. KIRANKUMAR KHANDARE	128
19	USE OF <i>POLYALTHIA LONGIFOLIA</i> AS BIOPESTICIDE: ADVANCEMENT TO TREAT FUNGAL DISEASE OF SOME MEDICINAL PLANTS	DR. MANISHA S. SUTARE	133
20	INVESTIGATION OF PHYSICO-CHEMICAL AND BIOACTIVE PROPERTIES OF HONEY FROM THE RAIGAD DISTRICT OF MAHARASHTRA STATE	KALPIT MHATRE AND ALOK GUDE	137
21	PROXIMATE ANALYSIS OF <i>PORTULACARIA AFRA.</i> JACQ.	RUCHIRA JAVKAR AND ANIL AVHAD	143
22	DIVERSITY OF MANGROVES AT JAITAPUR (RATNAGIRI DISTRICT), MAHARASHTRA STATE	DR. KALPIT MHATRE, RAJENDRA SHEVDE AND MAHADEO BADGE	149
23	PRODUCTION OF CYANOBACTERIAL BIOFERTILIZER AND ITS APPLICATION IN PADDY FIELDS.	A. A. ATNOORKAR	155
24	TRADITIONAL USES OF MEDICINAL PLANTS BY RURAL ZONE OF SAIKHEDA TAL-NIPHAD, DIST-NASHIK (MS)	S.V. GOSAVI	163
25	EFFECT OF STORAGE CONTAINER AND STORAGE PERIOD ON INCIDANCE OF FUNGI OF FOODGRAINS	ANIL U. KULKARNI, AND ASHOK M. CHAVAN	171
26	EFFECT OF MEDICINAL PLANTS LEAF EXTRACTS ON GROWTH AND SPORULATION OF FUNGI.	ANIL N. KORPENWAR AND DEEPMALA A . GAIKWAD	188
27	6 CURRENT STATUS OF RESEARCH ON MUSHROOM CULTIVATION IN INDIA	YUVRAJ D. KENGAR ILAH I. MUJAWAR AND NARAYAN D. TOTEWAD	195

I
N
D
E
X

52. Plant Physiology and Metabolism

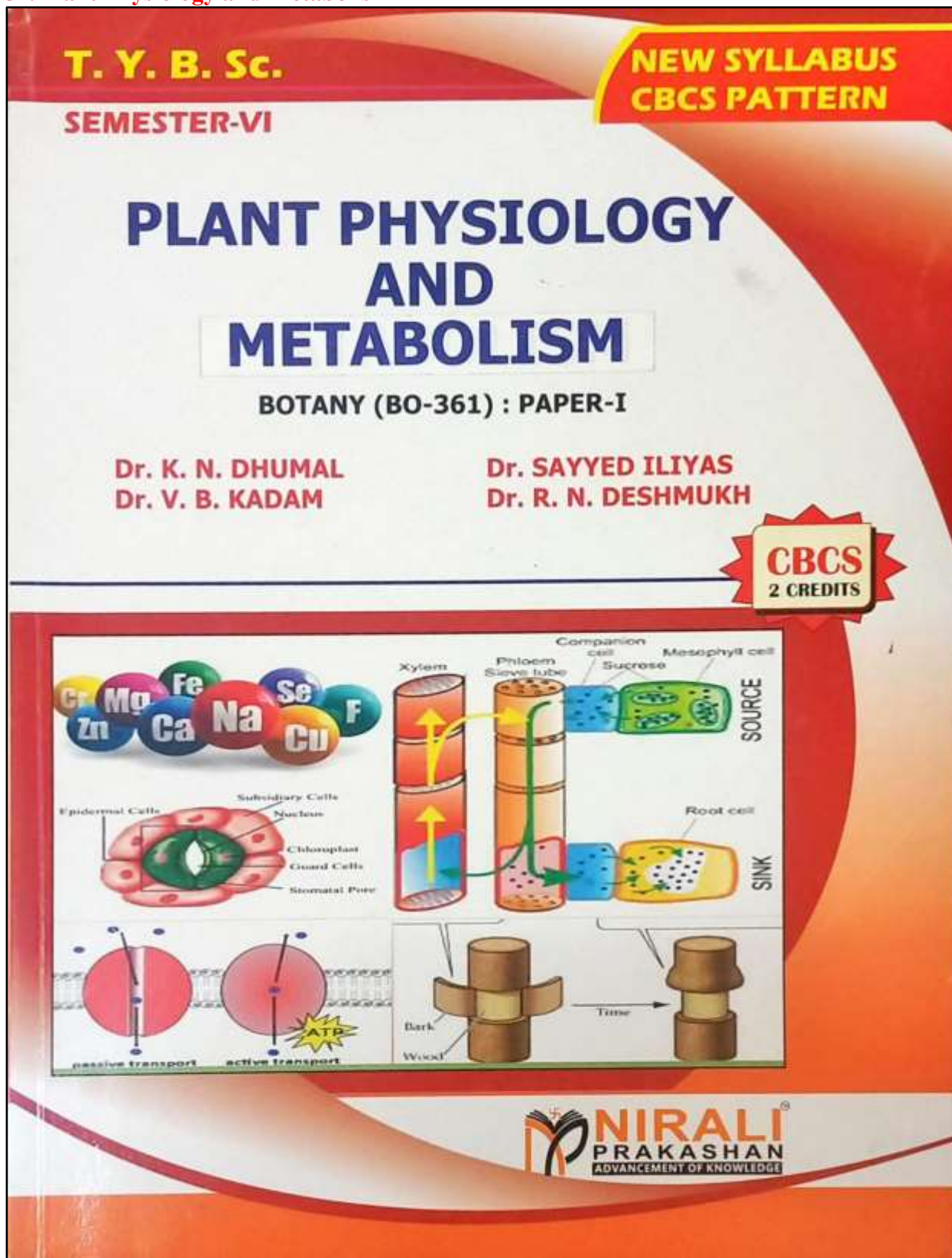

SPPU New Syllabus

A Text Book Of

PLANT PHYSIOLOGY AND METABOLISM

for

[BO - 361] [2 Credits]

Third Year B.Sc. Botany, Semester - VI : Paper - I
New Syllabus as per CBCS Pattern, June 2021

Dr. K. N. Dhumal

Former Professor
Dept. of Botany
Savitribai Phule Pune University
Pune

Dr. Sayyed Iliyas

Associate Professor
Dept. of Botany
Poona College of Arts, Science and
Commerce, Camp, Pune

**Specimen Copy for
Review & Recommendation**

Dr. V. B. Kadam

Professor
P.G. Dept. of Botany and Research Center
K.T.H.M. College, Nasik

Dr. R. N. Deshmukh

Associate Professor & Head Dept. of Botany
New Arts, Commerce & Science College
Parner, Dist. Ahmednagar

Price ₹ 150.00

RAJU SHAIKH

(Marketing / Sales)
NIRALI PRAKASHAN, PUNE
Mob. 9850547359, 07588948537

 **NIRALI**
PRAKASHAN
ADVANCEMENT OF KNOWLEDGE

N5935

T.Y.B.Sc. PLANT PHYSIOLOGY AND METABOLISM (BO-361) (S-VI)

First Edition : January 2022

ISBN 978-93-5451-419-7

© : Authors

The text of this publication or any part thereof, should not be reproduced or transmitted in any form or stored in any computer storage system or device for distribution including photocopy, recording, taping or information retrieval system or reproduced on any disc, tape, perforated media or other information storage device etc., without the written permission of Authors with whom the rights are reserved. Breach of this condition is liable for legal action.

Every effort has been made to avoid errors or omissions in this publication. In spite of this, errors may have crept in. Any mistake, error or discrepancy so noted and shall be brought to our notice shall be taken care of in the next edition. It is notified that neither the publisher nor the authors or seller shall be responsible for any damage or loss of action to any one, of any kind in any manner, therefrom. The reader must cross check all the facts and contents with original Government notification or publications.

Published By :

NIRALI PRAKASHAN

Abhyudaya Pragati, 1312, Shivaji Nagar,

Off J.M. Road, Pune - 411005

Tel - (020) 25512336/37/39

Email : niralipune@pragationline.com

Polyplate

Printed By :

YOGIRAJ PRINTERS AND BINDERS

Survey No. 10/1A, Ghule Industrial Estate

Nanded Gaon Road

Nanded, Pune - 411041

DISTRIBUTION CENTRES**PUNE****Nirali Prakashan**

(For orders outside Pune)

S. No. 28/27, Dhayari Narhe Road, Near Asian College

Pune 411041, Maharashtra

Tel : (020) 24690204; Mobile : 9657703143

Email : bookorder@pragationline.com

Nirali Prakashan

(For orders within Pune)

119, Budhwar Peth, Jogeshwari Mandir Lane

Pune 411002, Maharashtra

Tel : (020) 2445 2044; Mobile : 9657703145

Email : niralilocal@pragationline.com

MUMBAI**Nirali Prakashan**

Rasdharma Co-op. Hsg. Society Ltd., 'D' Wing Ground Floor, 385 S.V.P. Road

Girgaum, Mumbai 400004, Maharashtra

Mobile : 7045821020, Tel : (022) 2385 6339 / 2386 9976

Email : niralimumbai@pragationline.com

DISTRIBUTION BRANCHES**DELHI****Nirali Prakashan**

Room No. 2 Ground Floor

4575/15 Omkar Tower, Agarwal Road

Darya Ganj, New Delhi 110002

Mobile : 9555778814/9818561840

Email : delhi@niralibooks.com

BENGALURU**Nirali Prakashan**

Maitri Ground Floor, Jaya

Apartments, No. 99, 6th Cross, 6th

Main, Malleswaram, Bengaluru

560003 Karnataka; Mob : 9686821074

Email : bengaluru@niralibooks.com

NAGPUR**Nirali Prakashan**

Above Maratha Mandir, Shop No. 3,

First Floor, Rani Jhanshi Square,

Sitabuldi Nagpur 440012 (MAH)

Tel : (0712) 254 7129

Email : nagpur@niralibooks.com

KOLHAPUR**Nirali Prakashan**

New Mahadvar Road, Kedar Plaza,

1st Floor Opp. IDBI Bank

Kolhapur 416 012 Maharashtra

Mob : 9850046155

Email : kolhapur@niralibooks.com

JALGAON**Nirali Prakashan**

34, V. V. Golani Market, Navi Peth,

Jalgaon 425001, Maharashtra

Tel : (0257) 222 0395

Mob : 94234 91860

Email : jalgaon@niralibooks.com

SOLAPUR**Nirali Prakashan**

R-158/2, Avanti Nagar, Near Golden

Gate, Pune Naka Chowk

Solapur 413001, Maharashtra

Mobile 9890918687

Email : solapur@niralibooks.com

marketing@pragationline.com | www.pragationline.com

Also find us on  www.facebook.com/niralibooks

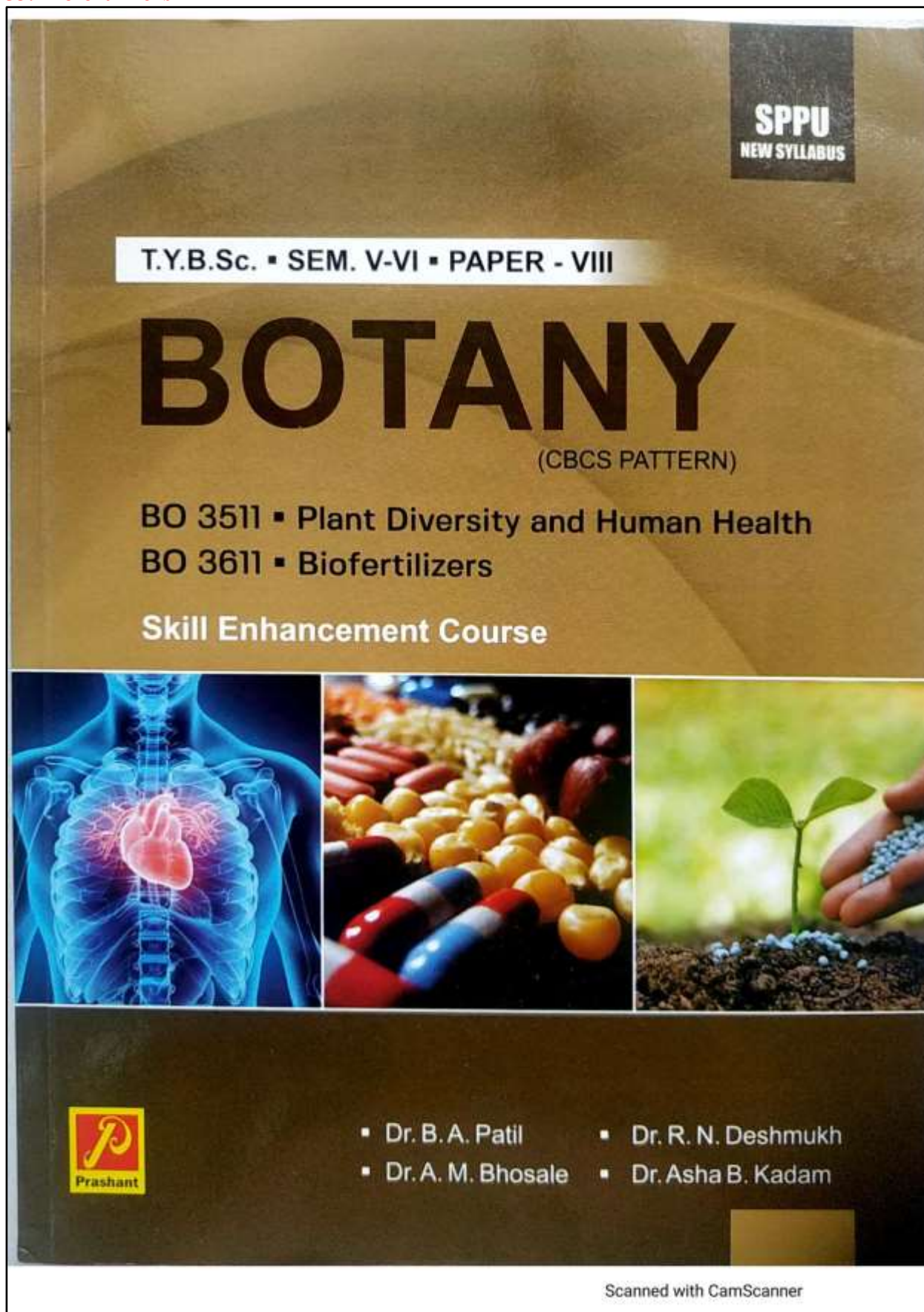
53. Biofertilizers

As per Revised Syllabus of
SAVITRIBAI PHULE PUNE UNIVERSITY

w.e.f. June 2021, (CBCS PATTERN)

T.Y.B.Sc. TEXT BOOKS



Download **Prashant Publications** app for e-Books

Corporate Office :

PRASHANT PUBLICATIONS

3, Pratap Nagar, Shri Sant Dnyaneshwar Mandir Road,
 Near Nutan Maratha College, Jalgaon - 425 001, (India)

Ph. : 0257-2235520, 2232800

E-Mail : prashantpublication.jal@gmail.com
 Visit us at www.prashantpublications.com

Also Available in
e-Book



₹ 195

ISBN 978-93-92425-26-4



9 789392 425264

T. Y. B. Sc.
SEMESTER-VI

NEW SYLLABUS
CBCS PATTERN

PLANT PHYSIOLOGY AND METABOLISM

BOTANY (BO-361) : PAPER-I

Dr. K. N. DHUMAL
Dr. V. B. KADAM

Dr. SAYYED ILIYAS
Dr. R. N. DESHMUKH

CBCS
2 CREDITS

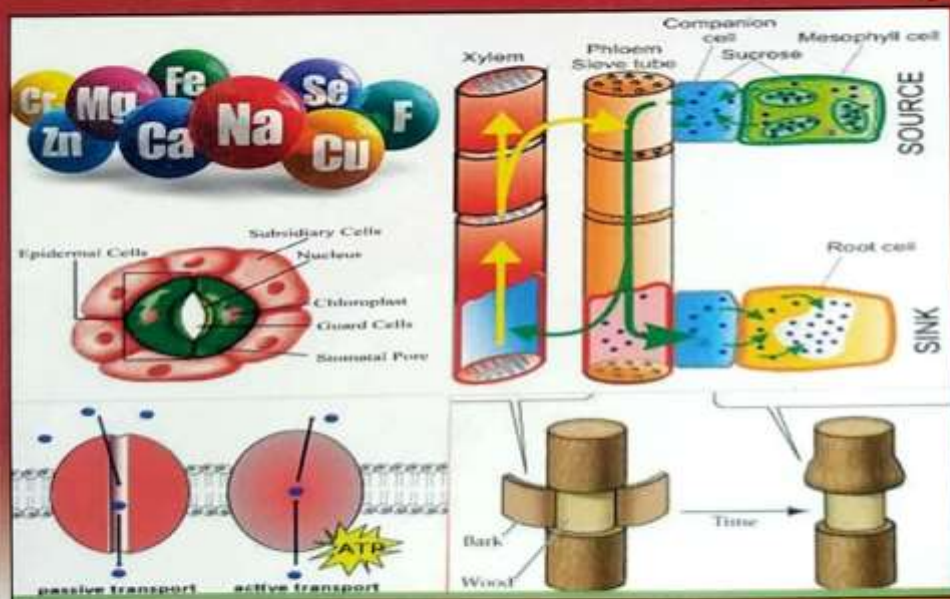

NIRALI
PRAKASHAN
ADVANCEMENT OF KNOWLEDGE



Our Text Books for Third Year B. Sc. As per New Syllabus CBCS Pattern : Semester-VI

- **SOLID STATE PHYSICS** : (Physics Paper-1) : Dr. S. D. Aghav, B. M. Laware, Dr. P. S. Tambade, V. K. Dhas
- **QUANTUM MECHANICS** : (Physics Paper-2) : Dr. P. S. Tambade, Dr. S. D. Aghav, B. M. Laware, V. K. Dhas
- **THERMODYNAMICS AND STATISTICAL PHYSICS** (Physics Paper-3) : V. K. Dhas, Dr. S. D. Aghav, B. M. Laware, Dr. P. S. Tambade
- **NUCLEAR PHYSICS** (Physics Paper-4) : Dr. P. S. Tambade, Dr. S. D. Aghav, B. M. Laware, V. K. Dhas
- **ELECTRONICS-II** (Physics Paper-5) : B. M. Laware, Dr. P. S. Tambade, Dr. S. D. Aghav, V. K. Dhas
- **ELEMENTS OF MATERIAL SCIENCE** (Elective) : Dr. R. B. Bhise, Dr. A. B. Bhise, Dr. K. C. Mohite, Dr. S. M. Rathod
- **PHYSICAL CHEMISTRY-II** : (Chemistry Paper-I) : Dr. V. M. Shinde, Prof. Dr. S. S. Borhade, Dr. B. S. Desale
- **PHYSICAL CHEMISTRY-III** : (Chemistry Paper-II) : Prof. Dr. S. S. Borhade, S. N. Labade, M. D. Banait, Prof. Dr. G. S. Gugale
- **INORGANIC CHEMISTRY-II** : (Chemistry Paper-IV) :
Prof. Dr. G. S. Gugale, Prof. Dr. R. A. Pawar, Prof. Dr. A. V. Nagawade, Prof. Dr. D. R. Thube, Prof. Dr. V. D. Bobade
- **INORGANIC CHEMISTRY-III** : (Chemistry Paper-V) :
Prof. Dr. G. S. Gugale, Prof. Dr. A. V. Nagawade, Prof. Dr. R. A. Pawar, Prof. Dr. D. R. Thube
- **ORGANIC CHEMISTRY-II** : (Chemistry Paper-VII) :
Prof. Dr. V. D. Bobade, Prof. Dr. P. K. Chhattise, Prof. Dr. S. V. Jagtap, Prof. Dr. G. S. Gugale
- **ORGANIC CHEMISTRY-III** : (Chemistry Paper-VIII) :
Prof. Dr. V. D. Bobade, Dr. M. A. Bora, Prof. Dr. S. V. Jagtap, Prof. Dr. P. K. Chhattise
- **CHEMISTRY OF SOILS AND AGROCHEMICALS** : (Chemistry Paper-X) Elective
Dr. R. P. Dhok, Dr. M. H. Moulavi, Prof. Dr. G. S. Gugale
- **INTRODUCTION TO FORENSIC CHEMISTRY** (Chemistry Paper-XI) Elective
Dr. S. V. Deore, K. D. Bodave, Dr. S. D. Gaikwad, Prof. Dr. G. S. Gugale
- **ANALYTICAL CHEMISTRY-II** (Chemistry Paper-XII) Elective
Prof. Dr. R. P. Patil, Dr. S. D. Gaikwad, Dr. Y. R. Baste, Prof. Dr. G. S. Gugale
- **CHEMISTRY OF COSMETICS AND PERFUMES** (Chemistry Paper-XIII) Elective
Dr. S. V. Deore, Dr. S. D. Gaikwad, D. D. Gaikwad, Prof. Dr. G. S. Gugale
- **PRACTICAL CHEMISTRY-II** : (Chemistry Paper-III, VI, IX)
Prof. Dr. G. S. Gugale, Dr. V. M. Shinde, Prof. Dr. V. D. Bobade, Prof. Dr. P. K. Chhattise,
Prof. Dr. A. V. Nagawade, Prof. Dr. R. A. Pawar, Prof. Dr. D. R. Thube, Prof. Dr. S. S. Borhade
- **MEDICAL AND FORENSIC ZOOLOGY** : (Zoology Paper-1) : Dr. Kishore Pawar, Dr. Ashok E. Desai
- **ANIMAL PHYSIOLOGY** : (Zoology Paper-2) : Dr. Kishore Pawar, Dr. Ashok E. Desai
- **MOLECULAR BIOLOGY** : (Zoology Paper-3) : Dr. Kishore Pawar, Dr. Ashok E. Desai
- **ENTOMOLOGY** : (Zoology Paper-4) : Dr. Kishore Pawar, Dr. Ashok E. Desai
- **TECHNIQUES IN BIOLOGY** : (Zoology Paper-5) : Dr. Kishore Pawar, Dr. Ashok E. Desai
- **EVOLUTIONARY BIOLOGY** : (Zoology Paper-6) : Dr. Kishore Pawar, Dr. Ashok E. Desai
- **PLANT PHYSIOLOGY AND METABOLISM** : (Botany Paper-1) : Dr. K. N. Dhupal, Dr. Sayyad Ilyas, Dr. V. B. Kadam, Dr. R. N. Deshmukh
- **BIOCHEMISTRY** : (Botany Paper-2) : Dr. K. N. Dhupal, Dr. Sayyad Ilyas
- **PLANT PHYSIOLOGY AND METABOLISM** : (Botany Paper-1) : Dr. K. N. Dhupal, Dr. Sayyad Ilyas, Dr. V. B. Kadam, Dr. R. N. Deshmukh
- **BIOCHEMISTRY** : (Botany Paper-2) : Dr. K. N. Dhupal, Dr. Sayyad Ilyas
- **PLANT PATHOLOGY** (Botany Paper-3) :
Dr. K. N. Dhupal, Dr. V. D. Ranade, Dr. K. R. Ranadive, Dr. N. M. Ghangaonkar, Dr. Mahesh Borde, Dr. P. Y. Lamrood
- **EVOLUTION AND POPULATION GENETICS** (Botany Paper-4) : Dr. K. N. Dhupal, Dr. N. A. Ghayal, Dr. S. S. Jagtap, Dr. B. M. Shinde
- **ADVANCED PLANT BIOTECHNOLOGY** (Botany Paper-5) : Dr. K. N. Dhupal, Dr. B. P. Shinde, Dr. Gauri Abhyankar, Ms. Komal Sawant
- **PLANT BREEDING AND SEED TECHNOLOGY** (Botany Paper-6) :
Dr. K. N. Dhupal, Dr. A. M. Bhosale, Dr. S. N. Bolbhat, Dr. N. B. Admutha, Dr. K. V. Palghadmal
- **NURSERY AND GARDENING MANAGEMENT** (Botany Paper-10) :
Dr. K. N. Dhupal, Dr. Madhuri Pagaria, Dr. Shilpa Dhupal, Dr. Pravina Taware
- **BIOFERTILIZERS** (Botany Paper-11) : Dr. K. N. Dhupal, P. B. Landage, Dr. V. B. Naikawadi
- **MEDICAL MICROBIOLOGY-II** (Microbiology Paper-1) : Dr. Rajashree B. Patwardhan, Dr. Pragati Sunil Abhyankar
- **IMMUNOLOGY-II** (Microbiology Paper-2) : Dr. Rajashree B. Patwardhan, Dr. Pragati S. Abhyankar
- **METABOLISM** (Microbiology Paper-3) : Dr. Pragati Sunil Abhyankar, Dr. Rajashree B. Patwardhan
- **MOLECULAR BIOLOGY** (Microbiology Paper-4) :
Mangesh Deshpande, Sunita Sakure, Dr. Rajashree B. Patwardhan, Dr. Pragati Sunil Abhyankar
- **FERMENTATION TECHNOLOGY-II** (Microbiology Paper-5) :
Dr. Suneel Gore and Saylee Kalekar, Dr. Pragati Sunil Abhyankar, Dr. Rajashree B. Patwardhan
- **FOOD MICROBIOLOGY** (Microbiology Paper-6) :
Dr. Neelima Kulkarni, Vaishali Prabhune, Dr. Pragati Sunil Abhyankar, Dr. Rajashree B. Patwardhan
- **WASTE MANAGEMENT** (Microbiology Paper-X) :
Dr. Pragati Sunil Abhyankar, Dr. Rajashree B. Patwardhan
- **NANOTECHNOLOGY** (Microbiology Paper-XI) : Jyotsna Dixit, Sayyke, Dr. Rajashree B. Patwardhan, Dr. Pragati Sunil Abhyankar

niralipune@pragationline.com

www.pragationline.com

Also find us on

 www.facebook.com/niralibooks  @nirail.prakashan



54. Archegoniate

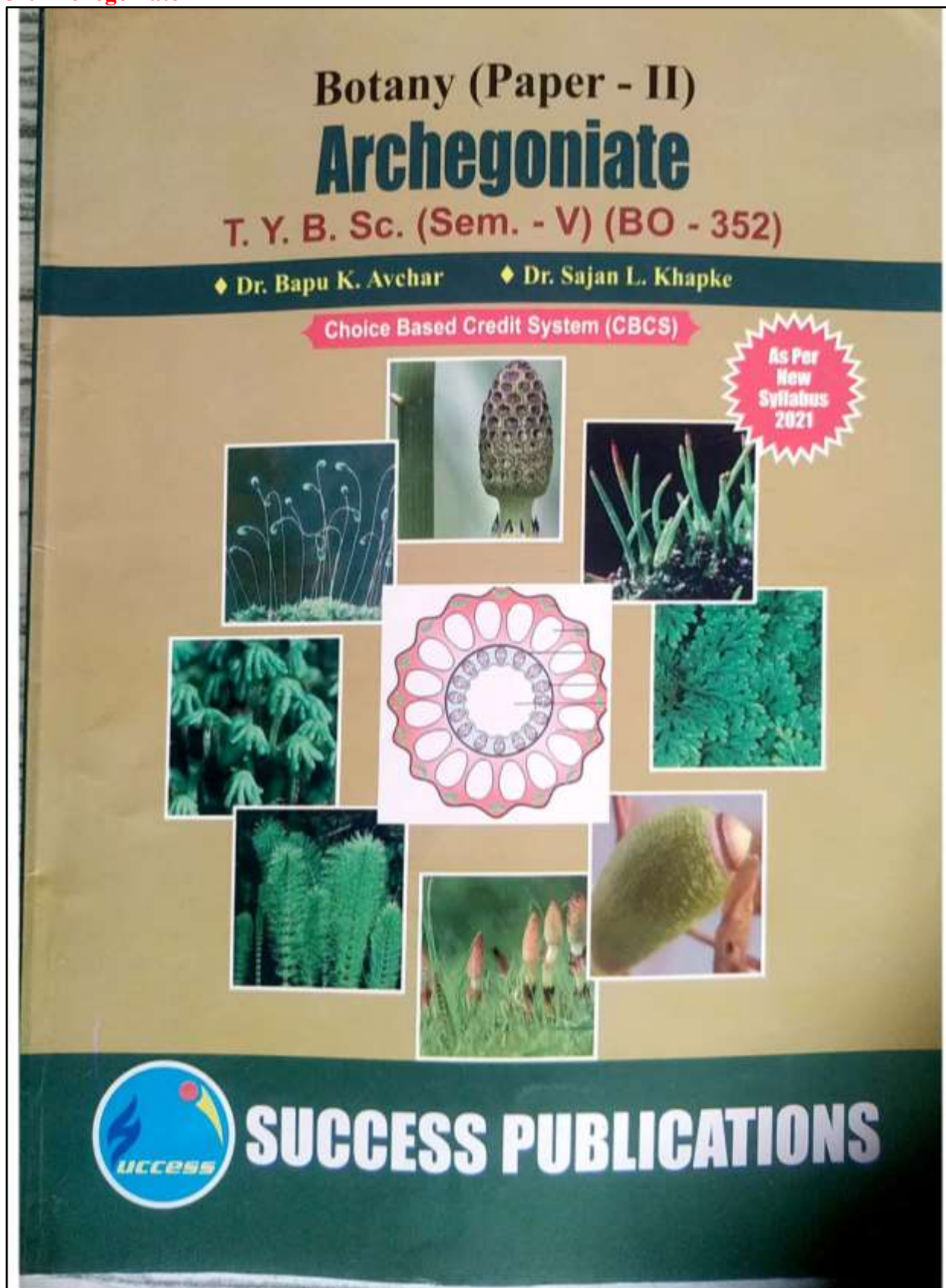



Dr. Babu Kundlik Avchar

M.Sc., Ph.D., LL. B.

Vidya Pratishthan's Arts, Science and Commerce College, Vidyanagari,
Baramati.

Dr. B. K. Avchar is currently working as Associate Professor at Vidya Pratishthan's Arts, Science and Commerce College, Vidyanagari, Baramati, Dist-Pune (MS). He has 26 years of teaching & research experience at Under Graduate and Post Graduate levels. He is a Recognized Guide for Ph. D. students at Savitribai Phule Pune University, Pune. He has published more than ten research papers in international reputed journals. He holds important academic positions such as Principal, Vidya Pratishthan's Commerce and Science College, Indapur, Dist-Pune and Member, Board of Studies in Botany, Savitribai Phule Pune University, Pune. He has attended and participated various National and International Seminars and Conferences. He has authored two reference books entitled "Weed Allelopathy" published by Lambert Academic Publishing, Germany and "Plant Diversity and Ecology" published by Success Publication, Pune. He is author of more than 20 text books for B.Sc. Botany students of SPPU, Pune.



Dr. Sajan Laxman Khapke

M.Sc., B.Ed., M. Phill., Ph.D.

New Arts, Commerce and Science College, Parner, Ahmednagar.

Dr. Sajan L. Khapke is currently working as Associate Professor of Botany at Ahmednagar Jilha Maratha Vidya Prasarak Samaj's New Arts, Commerce and Science College, Parner, Dist.-Ahmednagar (MS). He has 27 years of teaching and research experience at Under Graduate and Post Graduate levels. He has published more than twenty one research papers in National and International reputed journals. He has participated and presented research papers in various National and International Seminars and Conferences. He has authored a reference book entitled "Mycorrhiza and Plant Physiology" published by Vishva Pustak Prakashan, New Delhi - 110063.

ISBN : 978-93-24457-49-2



SUCCESS PUBLICATIONS

Address : Radha Krishna Apartment, 535, Shaniwar Peth,
Appa Balwant Chowk, Opp. Prabhat Theatre, Pune - 30.
Ph. No. 24434662, Mobile : 9325315464
E-mail : sharpgroup31@rediffmail.com
Website : www.sharpmultinational.com

PT-
3561

55. CH-504: Inorganic Chemistry (CBCS)

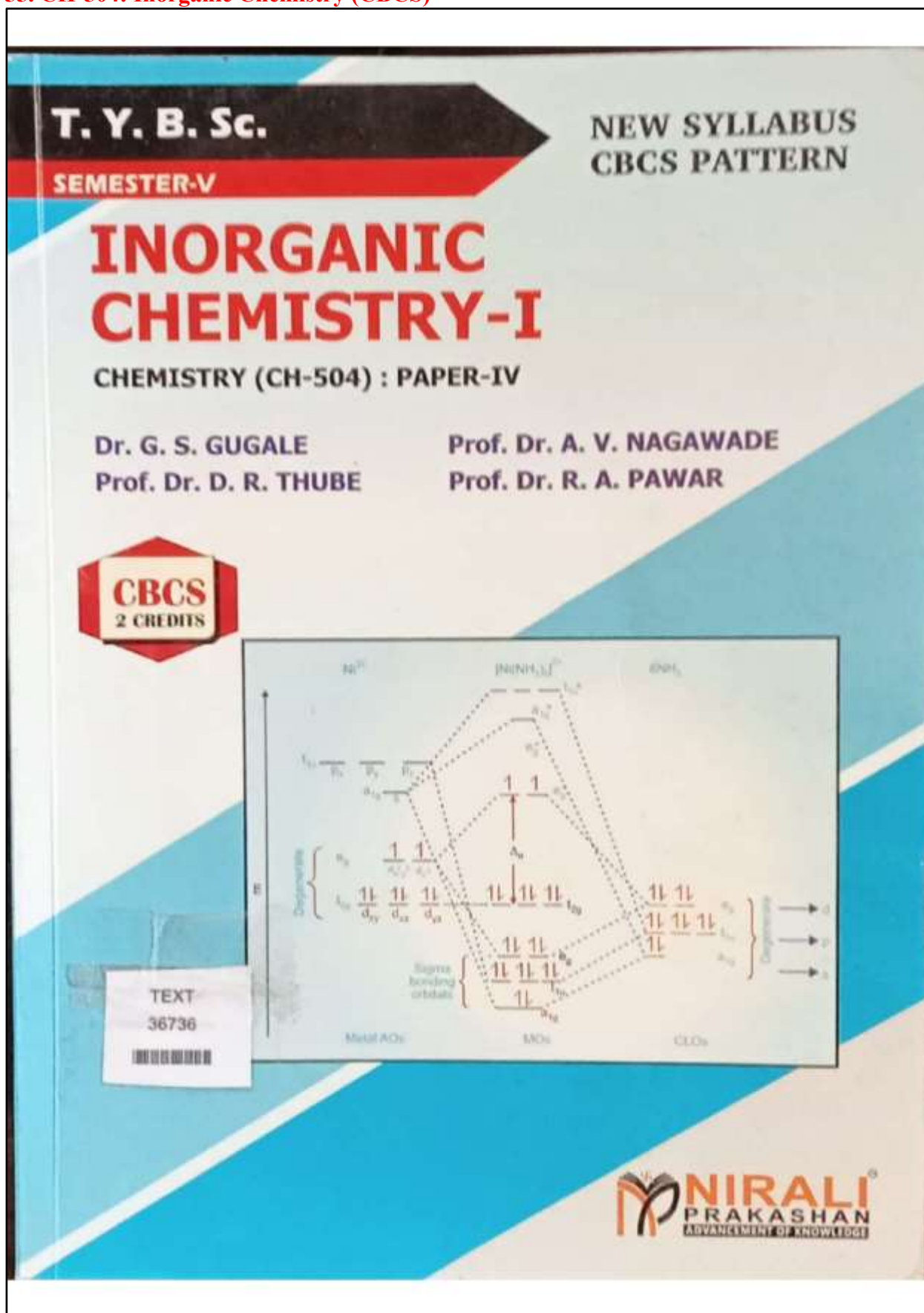

T.Y.B.Sc. INORGANIC CHEMISTRY-I (S-V)**ISBN 978-93-5451-348-0**

First Edition : September 2021

© : Authors

The text of this publication, or any part thereof, should not be reproduced or transmitted in any form or stored in any computer storage system or device for distribution including photocopy, recording, taping or information retrieval system or reproduced on any disc, tape, perforated media or other information storage device etc., without the written permission of Authors with whom the rights are reserved. Breach of this condition is liable for legal action.

Every effort has been made to avoid errors or omissions in this publication. In spite of this, errors may have crept in. Any mistake, error or discrepancy so noted and shall be brought to our notice shall be taken care of in the next edition. It is notified that neither the publisher nor the authors or seller shall be responsible for any damage or loss of action to any one, of any kind, in any manner, therefrom. The reader must cross check all the facts and contents with original Government notification or publications.

Published By :

NIRALI PRAKASHAN

Abhyudaya Pragati, 1312, Shivaji Nagar,

Off.J.M. Road, Pune – 411005

Tel – (020) 25512336/37/39

Email : niralipune@pragationline.com

Polyplate

Printed By :

YOGIRAJ PRINTERS AND BINDERS

Survey No. 10/1A, Ghule Industrial Estate

Nanded Gaon Road

Nanded, Pune - 411041

DISTRIBUTION CENTRES**PUNE****Nirali Prakashan**

(For orders outside Pune)

S. No. 28/27, Dhayari Narhe Road, Near Asian College,

Pune 411041, Maharashtra

Tel : (020) 24690204; Mobile : 9657703143

Email : bookorder@pragationline.com

Nirali Prakashan

(For orders within Pune)

119, Budhwar Peth, Jogeshwari Mandir Lane

Pune 411002, Maharashtra

Tel : (020) 2445 2044; Mobile : 9657703145

Email : niralilocal@pragationline.com

MUMBAI**Nirali Prakashan**

Rasdharma Co-op. Hsg. Society Ltd., 'D' Wing Ground Floor, 385 S.V.P. Road

Girgaum, Mumbai 400004, Maharashtra

Mobile : 7045821020, Tel : (022) 2385 6339 / 2386 9976

Email : niralimumbai@pragationline.com

DISTRIBUTION BRANCHES**DELHI****Nirali Prakashan**

Room No. 2 Ground Floor

4575/15 Omkar Tower, Agarwal Road

Darya Ganj, New Delhi 110002

Mobile : 9555778834/9818561840

Email : delhi@niralibooks.com

BENGALURU**Nirali Prakashan**

Maitri Ground Floor, Jaya Apartments,

No. 99, 6th Cross, 6th Main,

Malleswaram, Bengaluru 560003

Karnataka; Mob : 9686821074

Email : bengaluru@niralibooks.com

NAGPUR**Nirali Prakashan**

Above Maratha Mandir, Shop No. 3,

First Floor, Rani Jhanshi Square,

Sitabuldi Nagpur 440012 (MAH)

Tel : (0712) 254 7129

Email : nagpur@niralibooks.com

KOLHAPUR**Nirali Prakashan**

New Mahadvar Road, Kedar Plaza,

1st Floor Opp. IDBI Bank

Kolhapur 416 012 Maharashtra

Mob : 9850046155

Email : kolhapur@niralibooks.com

JALGAON**Nirali Prakashan**

34, V. V. Golani Market, Navi Peth,

Jalgaon 425001, Maharashtra

Tel : (0257) 222 0395

Mob : 94234 91860

Email : jalgaon@niralibooks.com

SOLAPUR**Nirali Prakashan**

R-158/2, Avanti Nagar, Near Golden

Gate, Pune Naka Chowk

Solapur 413001, Maharashtra

Mobile 9890918687

Email : solapur@niralibooks.com

marketing@pragationline.com | www.pragationline.com

Also find us on  www.facebook.com/niralibooks

Contents ...

1. Molecular Orbital Theory of Co-ordination Compounds	1.1 – 1.20
1.1 Introduction	1.1
1.2 Recapitulation of Electroneutrality Principle, Multiple Bonding, Nephelauxetic effect and need of MOT	1.2
1.2.1 Electroneutrality Principle	1.2
1.2.2 Multiple Bonding in Complexes (π -Bonding)	1.3
1.2.3 Nephelauxetic Effect and Nephelauxetic Series	1.4
1.3 Assumptions of MOT	1.6
1.4 M.O. Treatment of Bonding in Octahedral Complexes (without π Bonding)	1.6
1.4.1 Formation of MOs from metal orbitals and CLOs and Energy Level Diagram	1.6
1.4.2 M.O. Energy Level Diagram of $[\text{Ni}(\text{NH}_3)_6]^{2+}$ Complex Ion or d^8 System without π Bonding	1.9
1.4.3 M.O. Energy Level Diagram of $[\text{Ti}(\text{H}_2\text{O})_6]^{3+}$ without π Bonding	1.10
1.4.4 M.O. Energy Level Diagram of $[\text{CoF}_6]^{3-}$ without π Bonding	1.11
1.4.5 M.O. Energy Level Diagram of $[\text{Cu}(\text{CN})_6]^{3-}$ without π Bonding	1.11
1.5 Octahedral Complexes with π Bonding	1.13
1.5.1 Effect of π Bonding on Complexes	1.14
1.6 Charge Transfer Spectra (CTS)	1.15
1.7 Advantages of MOT over VBT and CFT	1.16
• Exercise	1.17
2. Inorganic Reaction Mechanism	2.1 – 2.16
2.1 Introduction	2.1
2.2 Basic Concepts of Stability and Lability	2.2
2.2.1 Labile and Inert Complexes on the basis of Valence Bond Theory	2.4
2.2.2 Labile and Inert Complexes on the basis of Crystal Field Theory	2.4
2.3 Stability Constants	2.5
2.4 Factors affecting Lability	2.6
2.5 Chelate Effect	2.7
2.6 Classification of Inorganic Reactions	2.7
2.7 Ligand Substitution Reactions : Intimate and Stoichiometric Mechanism of Ligand Substitution	2.8
2.8 Substitution Reactions in Four Co-ordinated Square Planar Complexes	2.10
2.9 Trans Effect and Trans Effect Series	2.12
2.10 Applications of Trans Effect	2.12
2.11 Stereochemistry of Substitution Reactions	2.13
• Exercise	2.13



3. Chemistry of Transition Elements	3.1 – 3.16
3.1 Introduction	3.1
3.2 Position in the Periodic Table	3.2
3.3 Electronic Configuration	3.3
3.4 Trends in the Properties of d-Block Elements	3.3
3.4.1 Size of Atoms and Ions	3.3
3.4.2 Reactivity	3.4
3.4.3 Catalytic Activity	3.4
3.4.4 Oxidation State	3.5
3.4.5 Complex Formation Ability	3.6
3.4.6 Colour	3.6
3.4.7 Magnetic Properties	3.7
3.4.8 Non-stoichiometry	3.9
3.4.9 Density, Melting Point and Boiling Points	3.10
• Exercise	3.11
4. Chemistry of f-Block Elements	4.1 – 4.30
4.1 Introduction	4.1
	(A) Lanthanides
4.2 Lanthanides	4.3
4.2.1 Position of Lanthanides in the Periodic Table	4.3
4.2.2 Occurrence	4.3
4.2.3 General Characteristics of Lanthanides	4.4
4.2.4 Extraction of Lanthanides from Monazite Sand	4.12
4.2.5 Separation of Lanthanide Elements	4.13
4.2.6 Applications of Lanthanides	4.15
4.2.7 Misch Metal	4.16
	(B) Actinides
4.3 Actinides	4.17
4.3.1 General Characteristics of Actinides	4.17
4.3.2 General Methods of Preparation of Transuranic Elements	4.19
4.4 Nuclear Fuels and their Applications	4.23
4.5 IUPAC Nomenclature	4.23
4.6 Comparison between Lanthanides and Actinides	4.24
• Exercise	4.25

y

5. Metals, Semiconductors and Superconductors		5.1 - 5.32
5.1	Introduction	5.2
5.2	Nature of Bonding in Metals	5.2
5.3	Theories of Metallic Bond	5.3
5.3.1	Free Electron Theory	5.3
5.3.2	Pauling's Valence Bond Theory	5.3
5.3.3	Molecular Orbital Theory or Band Theory	5.4
5.4	Band Theory for Sodium Metal	5.4
5.5	$n(E)$ Curves	5.7
5.6	$N(E)$ Curves	5.9
5.7	Electrical Conductivity of Metals	5.10
5.7.1	Electrical Conductivity of Univalent Metals	5.10
5.7.2	Electrical Conductivity of Divalent Metals	5.11
5.7.3	Electrical Conductivity of Trivalent Metals	5.11
5.8	Number of Valence Electrons and Electrical Conductivity	5.12
5.9	Insulators	5.12
5.10	Effect of Temperature and Impurity on Conductivity	5.12
5.11	Semiconductors	5.14
5.11.1	Intrinsic Semiconductors	5.14
5.11.2	Extrinsic Semiconductors	5.14
5.12	Non-Stoichiometry and Semiconductivity	5.18
5.12.1	Crystals having Cation Vacancy in the Lattice	5.18
5.12.2	Crystals having Anion Vacancy in the Lattice	5.19
5.13	Conductors, Semiconductors and Insulators	5.20
5.14	Applications of Semiconductors	5.20
5.15	Superconductors	5.21
5.15.1	Introduction	5.21
5.15.2	Discovery	5.22
5.15.3	Structure of Superconducting Oxides	5.24
5.15.4	Applications	5.26
•	Exercise	5.27

56. CH-604: Inorganic Chemistry (CBCS)

T. Y. B. Sc.

SEMESTER-VI

**NEW SYLLABUS
CBCS
2019 PATTERN**

INORGANIC CHEMISTRY-II

CHEMISTRY (CH-604) : PAPER-IV

Prof. Dr. G. S. GUGALE

Prof. Dr. R. A. PAWAR Prof. Dr. D. R. THUBE
Prof. Dr. V. D. BOBADE Prof. Dr. A. V. NAGAWADE

**CBCS
2 CREDITS**

Conduction Mechanism in Ionic Solid with Schottky Defect

$\text{Si}_3\text{O}_8^{4-}$ $\text{Si}_6\text{O}_{18}^{12-}$ B_3N_3

NIRALI PRAKASHAN
ADVANCEMENT OF KNOWLEDGE

T.Y.B.Sc. INORGANIC CHEMISTRY-II (S-VI)**ISBN 978-93-5451-474-6****First Edition : April 2022**© **Authors**

The text of this publication, or any part thereof, should not be reproduced or transmitted in any form or stored in any computer storage system or device for distribution including photocopy, recording, taping or information retrieval system or reproduced on any disc, tape, perforated media or other information storage device etc., without the written permission of Authors with whom the rights are reserved. Breach of this condition is liable for legal action.

Every effort has been made to avoid errors or omissions in this publication. In spite of this, errors may have crept in. Any mistake, error or discrepancy so noted and shall be brought to our notice shall be taken care of in the next edition. It is notified that neither the publisher nor the authors or seller shall be responsible for any damage or loss of action to any one, of any kind, in any manner, therefrom. The reader must cross check all the facts and contents with original Government notification or publications.

Published By :**NIRALI PRAKASHAN**

Abhyudaya Pragati, 1312, Shivaji Nagar,

Off J.M. Road, Pune - 411005

Tel - (020) 25512336/37/39

Email : niralipune@pragationline.com

Polyplate**Printed By :****YOGIRAJ PRINTERS AND BINDERS**

Survey No. 10/1A, Ghule Industrial Estate

Nanded Gaon Road

Nanded, Pune - 411041

DISTRIBUTION CENTRES**PUNE****Nirali Prakashan****(For orders outside Pune)**

S. No. 28/27, Dhayari Narhe Road, Near Asian College

Pune 411041, Maharashtra

Tel : (020) 24690204; Mobile : 9657703143

Email : bookorder@pragationline.com

Nirali Prakashan**(For orders within Pune)**

119, Budhwar Peth, Jogeshwari Mandir Lane

Pune 411002, Maharashtra

Tel : (020) 2445 2044; Mobile : 9657703145

Email : niralilocal@pragationline.com

MUMBAI**Nirali Prakashan**

Rasdharma Co-op. Hsg. Society Ltd., 'D' Wing Ground Floor, 385 S.V.P. Road

Girgaum, Mumbai 400004, Maharashtra

Mobile : 7045821020, Tel : (022) 2385 6339 / 2386 9976

Email : niralimumbai@pragationline.com

DISTRIBUTION BRANCHES**DELHI****Nirali Prakashan**

Room No. 2 Ground Floor

4575/15 Omkar Tower, Agarwal Road

Darya Ganj, New Delhi 110002

Mobile : 9555778814/9818561840

Email : delhi@niralibooks.com

KOLHAPUR**Nirali Prakashan**

438/2, Bhosale Plaza, Ground Floor

Khasbag, Opp. Balgopal Talim

Kolhapur 416 012, Maharashtra

Mob : 9850046155

Email : kolhapur@niralibooks.com

BENGALURU**Nirali Prakashan**

Maitri Ground Floor, Jaya Apartments,

No. 99, 6th Cross, 6th Main,

Malleswaram, Bengaluru 560003

Karnataka; Mob : 9686821074

Email : bengaluru@niralibooks.com

JALGAON**Nirali Prakashan**

34, V. V. Golani Market, Navi Peth,

Jalgaon 425001, Maharashtra

Tel : (0257) 222 0395

Mob : 94234 91860

Email : jalgaon@niralibooks.com

NAGPUR**Nirali Prakashan**

Above Maratha Mandir, Shop No. 3,

First Floor, Rani Jhanshi Square,

Sitabuldi Nagpur 440012 (MAH)

Tel : (0712) 254 7129

Email : nagpur@niralibooks.com

SOLAPUR**Nirali Prakashan**

R-158/2, Avanti Nagar, Near Golden

Gate, Pune Naka Chowk

Solapur 413001, Maharashtra

Mobile 9890918687

Email : solapur@niralibooks.com

marketing@pragationline.com | www.pragationline.com

Also find us on : www.facebook.com/niralibooks

Contents ...

1. ORGANOMETALLIC CHEMISTRY	1.1 – 1.20
1.1 Introduction	1.1
1.2 Carbonyl Complexes	1.2
1.2.1 CO as a π -Acid Donor Ligand	1.2
1.3 Binary Carbonyl Complexes	1.4
1.4 Methods of Synthesis	1.5
1.4.1 Direct Reaction of Metal with CO	1.5
1.4.2 Reductive Carbonylation	1.6
1.4.3 Photolysis and Thermolysis	1.6
1.5 Molecular and Electronic Structures	1.6
1.5.1 The 18-Electron Rule	1.8
1.6 Applications of Organometallic Compounds	1.13
1.7 Ferrocene	1.13
1.7.1 Introduction	1.13
1.7.2 Synthesis	1.14
1.7.3 Physical Properties	1.14
1.7.4 Reactions of Ferrocene	1.14
• Summary	1.16
• Exercise	1.16
2. HOMOGENEOUS AND HETEROGENEOUS CATALYSIS	2.1 – 2.26
2.1 Introduction	2.2
2.1.1 Homogeneous Catalysts	2.3
2.1.2 Heterogeneous Catalysts	2.4
2.2 Importance of Catalysis in the Synthesis of High Value Chemicals	2.4
(A) Homogeneous Catalysis	
2.3 Homogeneous Catalysis and its Types	2.5
2.3.1 Essential Properties of Homogeneous Catalysts	2.5
2.3.2 Catalytic Reactions	2.6
(B) Heterogeneous Catalysis	
2.4 Introduction	2.12
2.5 Classes of Heterogeneous Catalysts	2.12
2.6 Heterogeneous Catalyst Works (In General Terms)	2.12
2.7 Examples of Heterogeneous Catalysis	2.13
2.8 Classification of Heterogeneous Catalysts	2.14
2.9 Properties of Heterogeneous Catalysts	2.15
2.10 Advantages and Disadvantages of Heterogeneous Catalysis	2.15
2.11 Catalytic Reactions	2.15
2.11.1 Catalytic Reactions involving Oxidation	2.15
2.11.2 Catalytic Reactions involving Reduction	2.17
2.11.3 Catalytic Reactions involving Cyclization	2.19
2.11.4 Biodiesel Synthesis using Heteropolyacid Catalysts	2.20
• Summary	2.23
• Exercise	2.23
3. BIOINORGANIC CHEMISTRY	3.1 – 3.26
3.1 Introduction	3.1
3.2 Role of Metals in Bioinorganic Compounds	3.2
3.3 Classification of Metals as Enzymatic and Non-Enzymatic Metals	3.3
3.3.1 Enzymatic Redox Metals and Enzymatic Non-redox Metals	3.4
(a) Enzymatic Redox Metals such as Cu (SOD) and	
(b) Enzymatic Non-redox Metals such as Zn (Hydrolase)	
3.3.2 Role of Metal Ions in Non-enzymatic Processes –	
Compounds of Na, K, Ca and Mg	3.5

3.3.3	Role of Transition Metals in Enzymatic Processes (Redox Active)	3.7
	(a) Catalase, (b) Peroxidase and (c) Nitrogenase	3.9
3.4	Metalloproteins of Iron	3.9
3.4.1	Iron Sulphur Proteins: Fe-S Proteins	3.13
3.4.2	Iron Storage Protein (Ferritin)	3.14
3.4.3	Iron Transport Protein (Transferrin)	3.16
3.5	Bioinorganic Chemistry of Iron	3.17
3.5.1	Hemoglobin and Myoglobin	3.20
3.5.2	Partial Pressure of Oxygen	3.21
3.5.3	pH Dependence	3.21
3.5.4	Similarities and Differences in Hemoglobin and Myoglobin	3.21
3.6	Bioinorganic Chemistry of Cobalt : Vitamin B ₁₂	3.23
•	Summary	3.24
•	Exercise	3.24
4.	INORGANIC POLYMERS	4.1 - 4.22
4.1	Introduction	4.1
4.2	Basic Concepts of Polymers	4.2
4.3	Classification of Polymers	4.3
4.4	Comparison of Organic and Inorganic Polymers	4.4
4.5	Inorganic Polymers	4.5
4.6	Types / Classification of Inorganic Polymers	4.6
4.6.1	Mayer's Classification	4.6
4.6.2	Korshak and Mozyora's Classification	4.7
4.6.3	Classification based on Method of Preparation	4.7
4.6.4	Organometallic Polymers	4.7
4.7	Synthesis, Structural Aspects and Applications of Polymers	4.7
4.7.1	Silicates	4.7
4.7.2	Silicones	4.12
4.7.3	Siloxanes	4.14
4.7.4	Borazines (Borazole)	4.15
4.7.5	Phosphazenes	4.16
•	Summary	4.18
•	Exercise	4.19
5.	INORGANIC SOLIDS / IONIC LIQUIDS OF TECHNOLOGICAL IMPORTANCE	5.1 - 5.22
	Part - I : Inorganic Solids	
5.1	Inorganic Solids	5.1
5.2	Heat and Beat Method	5.2
5.3	The Sol-Gel Method	5.3
5.4	Coprecipitation Method	5.5
5.5	Hydrothermal Method	5.6
5.6	Introduction to Solid Electrolyte	5.7
5.7	Inorganic Liquid Crystals	5.10
	Part - II : Ionic Liquids	
5.8	Definition of Ionic Liquids	5.14
5.9	Synthesis of Ionic Liquids	5.14
5.10	Phosphonium Ion Based Ionic Liquids	5.17
5.11	Applications of Ionic Liquids	5.18
•	Summary	5.19
•	Exercise	5.20

57. CH-503, 506, 509: Chemistry Practical (CBCS)

T. Y. B. Sc.

SEMESTER-V

**NEW SYLLABUS
CBCS
2019 PATTERN**

PRACTICAL CHEMISTRY-I

CHEMISTRY (CH-503, 506, 509) : PAPER-III, VI, IX

Prof. Dr. G. S. GUGALE

Prof. Dr. A. V. NAGAWADE

Prof. Dr. R. A. PAWAR

Prof. Dr. P. K. CHHATTISE

Dr. V. M. SHINDE

Prof. Dr. V. D. BOBADE

Prof. Dr. D. R. THUBE

Dr. S. M. HANDE

CBCS

2 CREDITS

T.Y.B.Sc. PRACTICAL CHEMISTRY - I (Sem. V)

ISBN 978-93-5451-311-4

First Edition : November 2021

© : Authors

The text of this publication, or any part thereof, should not be reproduced or transmitted in any form or stored in any computer storage system or device for distribution including photocopy, recording, taping or information retrieval system or reproduced on any disc, tape, perforated media or other information storage device etc., without the written permission of Authors with whom the rights are reserved. Breach of this condition is liable for legal action.

Every effort has been made to avoid errors or omissions in this publication. In spite of this, errors may have crept in. Any mistake, error or discrepancy so noted and shall be brought to our notice shall be taken care of in the next edition. It is notified that neither the publisher nor the authors or seller shall be responsible for any damage or loss of action to any one, of any kind, in any manner, therefrom. The reader must cross check all the facts and contents with original Government notification or publications.

Published By :

NIRALI PRAKASHAN

Abhyudaya Pragati, 1312, Shivaji Nagar,

Off J.M. Road, Pune – 411005

Tel - (020) 25512336/37/39

Email : niralipune@pragationline.com

Polyplate

Printed By :

YOGIRAJ PRINTERS AND BINDERS

Survey No. 10/1A, Ghule Industrial Estate

Nanded Gaon Road

Nanded, Pune - 411041

DISTRIBUTION CENTRES**PUNE****Nirali Prakashan**

(For orders outside Pune)

S. No. 28/27, Dhayari Narhe Road, Near Aslan College

Pune 411041, Maharashtra

Tel : (020) 24690204; Mobile : 9657703143

Email : bookorder@pragationline.com

Nirali Prakashan

(For orders within Pune)

119, Budhwar Peth, Jogeshwari Mandir Lane

Pune 411002, Maharashtra

Tel : (020) 2445 2044; Mobile : 9657703145

Email : niralilocal@pragationline.com

MUMBAI**Nirali Prakashan**

Rasdharma Co-op. Hsg. Society Ltd., 'D' Wing Ground Floor, 385 S.V.P. Road

Girgaum, Mumbai 400004, Maharashtra

Mobile : 7045821020, Tel : (022) 2385 6339 / 2386 9976

Email : niralimumbai@pragationline.com

DISTRIBUTION BRANCHES**DELHI****Nirali Prakashan**

Room No. 2 Ground Floor

4575/15 Omkar Tower, Agarwal Road

Darya Ganj, New Delhi 110002

Mobile : 9555778814/9818561840

Email : delhi@niralibooks.com

BENGALURU**Nirali Prakashan**

Maitri Ground Floor, Jaya Apartments,

No. 99, 6th Cross, 6th Main,

Malleswaram, Bengaluru 560003

Karnataka; Mob : 9686821074

Email : bengaluru@niralibooks.com

NAGPUR**Nirali Prakashan**

Above Maratha Mandir, Shop No. 3,

First Floor, Rani Jhanshi Square,

Sitabuldi Nagpur 440012 (MAH)

Tel : (0712) 254 7129

Email : nagpur@niralibooks.com

KOLHAPUR**Nirali Prakashan**

438/2, Bhosale Plaza, Ground Floor

Khasbag, Opp. Balgopal Talim

Kolhapur 416 012, Maharashtra

Mob : 9850046155

Email : kolhapur@niralibooks.com

JALGAON**Nirali Prakashan**

34, V. V. Gofani Market, Navi Peth,

Jalgaon 425001, Maharashtra

Tel : (0257) 222 0395

Mob : 94234 91860

Email : jalgaon@niralibooks.com

SOLAPUR**Nirali Prakashan**

R-158/2, Avanti Nagar, Near Golden

Gate, Pune Naka Chowk

Solapur 413001, Maharashtra

Mobile 9890918687

Email : solapur@niralibooks.com

marketing@pragationline.com | www.pragationline.com

Also find us on  www.facebook.com/niralibooks

Contents ...

1. Physical Chemistry Practicals-I	1 - 9
1. Refractometry (Any Two)	1
Experiment 1 To determine specific refractivities of given liquids A and B and their mixture and hence determine the percentage composition of their mixture C.	3
Experiment 2 To determine the molecular refractivity of given liquids A, B, C, D.	5
Experiment 3 To determine the molar refraction of homologues methyl, ethyl and propyl alcohol and show the constancy contribution to the molar refraction by $-CH_2$ group.	7
Experiment 4 Determine the refractive index of a series of salt solutions and determine the concentration of a salt of unknown solution.	9
2. Spectrophotometry and Colorimetry (Any Three)	10 - 33
Experiment 5 To determine the amount of copper present in the given solution of copper sulphate by colorimetric titration method using standard solution of EDTA.	12
Experiment 6 To determine the indicator constant of methyl red indicator.	16
Experiment 7 To determine the concentration of given unknown solution of Fe(III) using ammonium thiocyanate at 540 nm by colorimetric method.	20
Experiment 8 To determine the concentration of given unknown cobalt solution using R-nitroso salt at 520 nm by colorimetric method.	24
Experiment 9 To determine the order of reaction for the oxidation of alcohol by potassium dichromate (or potassium permanganate) in the acidic medium colorimetrically (or spectrophotometrically).	27
Experiment 10 Determination of cations simultaneously from their mixture spectrophotometrically.	29
3. Conductometry	34 - 51
Experiment 11 Titration of a mixture of weak acid and strong acid with strong alkali.	38
Experiment 12 To determine the velocity constant of hydrolysis of ethyl acetate by NaOH solution by conductometric method.	41
Experiment 13 To determine the normality of citric acid in a given fruit by titrating it against standard NaOH solution by conductometric method.	43

Experiment 14	To determine λ_{∞} of strong electrolyte (NaCl or KCl) and to verify Onsager equation.	45
Experiment 15	To estimate the amount of lead present in a given solution of lead nitrate by conductometric titration with sodium sulphate.	47
Experiment 16	To determine the relative strength of monochloroacetic acid and acetic acid conductometrically.	49
4. Viscosity (Any One)		52 - 58
Experiment 17	To determine the molecular weight of a high polymer by using its solutions of different concentrations.	52
Experiment 18	Determine the radius of glycerol molecule from viscosity measurement.	56
5. Photofluorometry (Any One)		59 - 61
Experiment 19	Analysis of Riboflavin from vitamin supplementary capsules/syrup/tablet sample by photofluorometry method.	60
6. Table Work		62 - 65
Experiment 20	Analysis of the given Vibration-Rotation spectrum of HCl(g).	64
Appendices		66 - 81
2. Inorganic Chemistry Practicals-I		82 - 138
1. Gravimetric Estimations (Any Three)		82 - 95
Experiment 21	Gravimetric estimation of iron (Fe) as ferric oxide (Fe_2O_3) from ferrous ammonium sulphate.	82
Experiment 22	Gravimetric estimation of barium as barium sulphate by using sulphamic acid. (Homogeneous precipitation technique).	85
Experiment 23	Gravimetric estimation of nickel as nickel dimethyl glyoxamate.	87
Experiment 24	Determination of sodium bicarbonate from mixture of sodium carbonate and bicarbonate by thermal decomposition method.	90
Experiment 25	Determination of water of crystallization by thermal decomposition.	92
Experiment 26	Analysis of Food/Pharmaceutical sample for ash and sulphated ash. Example - Aspirin.	93
2. Inorganic Preparations (Any Three)		96 - 111
Experiment 27	To prepare hexamminenickel(II) chloride.	96
Experiment 28	To prepare potassium trioxalatoferrate(III) trihydrate and its purity determination by estimation of oxalate using permanganometry.	99
Experiment 29	Preparation of manganese(III) acetylacetonate, $[\text{Mn}(\text{acac})_3]$.	103

Experiment 30	Preparation of potassium tris(glycinato)nickelate(II), $K[Ni(gly)_3]^-$ complex.	105
Experiment 31	Preparation of potassium dioxalatocuprate(II) dihydrate, $K_2[Cu(C_2O_4)_2]^{2-} \cdot 2H_2O$.	108
3. Inorganic Qualitative Analysis (Five Mixtures)		112 - 132
Appendices		133 - 138
3. Organic Chemistry Practicals-I		139 - 176
1. Separation of Binary Mixtures and Qualitative Analysis (Any Six)		139
2. Preparations (a) Green Chemistry Preparations (Any Two)		160
Experiment 32	Preparation of dibenzalpropanone from benzaldehyde and acetone using $LiOH \cdot H_2O/NaOH$.	160
Experiment 33	Nitration of phenol or substituted phenols using $CaNO_3$.	162
Experiment 34	Bromination of acetanilide using ceric ammonium nitrate and KBr in the aqueous medium.	163
2. Preparations (b) Organic Preparations (Any Two)		166 - 170
Experiment 35	Preparation of 1,4-dihydropyrimidinone from ethyl acetoacetate, benzaldehyde and urea using oxalic acid as a catalyst.	166
Experiment 36	Preparation of p-iodonitrobenzene from p-nitroaniline by Sandmeyer reaction.	167
Experiment 37	Preparation of p-chlorobenzyl alcohol and p-chlorobenzoic acid from p-chloro benzaldehyde.	169
2. Preparations (c) Preparations of Organic Derivatives (Any Two)		171 - 176
Experiment 38	Amide derivative of carboxylic acid.	171
Experiment 39	Preparation of Glucosazone derivative of Glucose.	173
Experiment 40	Preparation of Paracetamol from p-aminophenol.	175
Appendices		177 - 179

❖ ❖ ❖

58. CH-603, 606, 609: Chemistry Practical (CBCS)

T. Y. B. Sc.

SEMESTER-VI

**NEW SYLLABUS
CBCS
2019 PATTERN**

PRACTICAL CHEMISTRY-II

CHEMISTRY (CH-603, 606, 609) : PAPER-III, VI, IX

Prof. Dr. G. S. GUGALE	Dr. V. M. SHINDE
Prof. Dr. V. D. BOBADE	Prof. Dr. P. K. CHHATTISE
Prof. Dr. A. V. NAGAWADE	Prof. Dr. R. A. PAWAR
Prof. Dr. D. R. THUBE	Prof. Dr. S. S. BORHADE
Dr. M. A. BORA	Dr. R. S. DIGGIKAR

**CBCS
2 CREDITS**

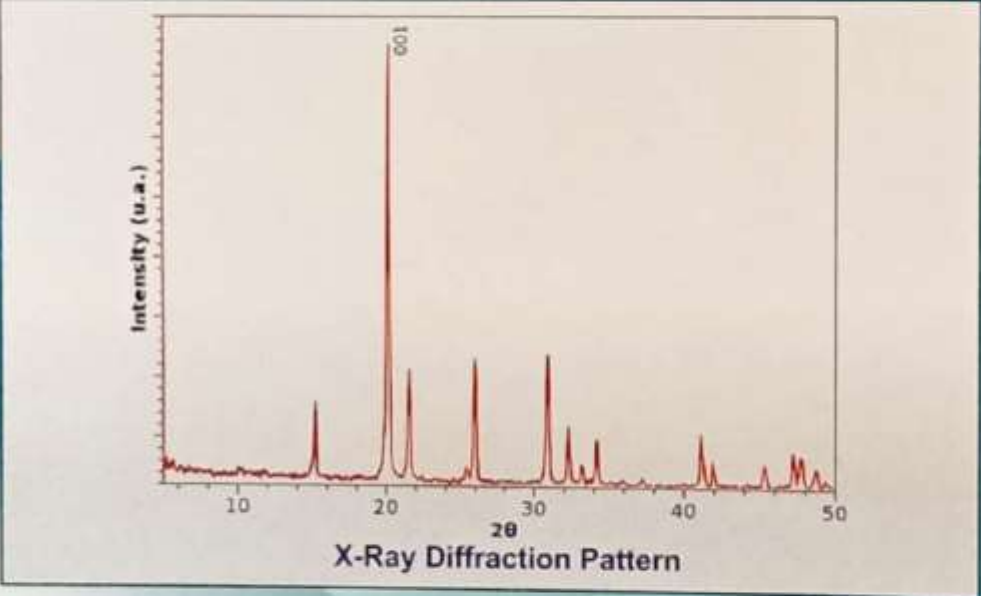

X-Ray Diffraction Pattern

**NIRALI
PRAKASHAN**
ADVANCEMENT OF KNOWLEDGE

T.Y.B.Sc. PRACTICAL CHEMISTRY-II (Sem. VI)**ISBN 978-93-5451-409-8**

First Edition : April 2022

© : Authors

The text of this publication, or any part thereof, should not be reproduced or transmitted in any form or stored in any computer storage system or device for distribution including photocopy, recording, taping or information retrieval system or reproduced on any disc, tape, perforated media or other information storage device etc., without the written permission of Authors with whom the rights are reserved. Breach of this condition is liable for legal action.

Every effort has been made to avoid errors or omissions in this publication. In spite of this, errors may have crept in. Any mistake, error or discrepancy so noted and shall be brought to our notice shall be taken care of in the next edition. It is notified that neither the publisher nor the authors or seller shall be responsible for any damage or loss of action to any one, of any kind, in any manner therefrom. The reader must cross check all the facts and contents with original Government notification or publications.

Published By :

NIRALI PRAKASHAN

Abhyudaya Pragati, 1312, Shivaji Nagar,

Off J.M. Road, Pune - 411005

Tel - (020) 25512336/37/39

Email : niralipune@pragationline.com

Polyplate

Printed By :

YOGIRAJ PRINTERS AND BINDERS

Survey No. 10/1A, Ghule Industrial Estate

Nanded Gaon Road

Nanded, Pune - 411041

DISTRIBUTION CENTRES**PUNE****Nirali Prakashan**

(For orders outside Pune)

S. No. 28/27, Dhayari Narhe Road, Near Asian College
Pune 411041, Maharashtra

Tel : (020) 24690204; Mobile : 9657703143

Email : bookorder@pragationline.com**Nirali Prakashan**

(For orders within Pune)

119, Budhwar Peth, Jogeshwari Mandir Lane
Pune 411002, Maharashtra

Tel : (020) 2445 2044; Mobile : 9657703145

Email : niralilocal@pragationline.com**MUMBAI****Nirali Prakashan**Rasdhara Co-op. Hsg. Society Ltd., 'D' Wing Ground Floor, 385 S.V.P. Road
Girgaum, Mumbai 400004, Maharashtra

Mobile : 7045821020, Tel : (022) 2385 6339 / 2386 9976

Email : niralimumbai@pragationline.com**DISTRIBUTION BRANCHES****DELHI****Nirali Prakashan**Room No. 2 Ground Floor
4575/15 Omkar Tower, Agarwal Road
Darya Ganj, New Delhi 110002
Mobile : 8555778814/9818561840
Email : delhi@niralibooks.com**BENGALURU****Nirali Prakashan**Maltri Ground Floor, Jaya Apartments,
No. 99, 6th Cross, 6th Main,
Malleswaram, Bengaluru 560003
Karnataka; Mob : 9686821074
Email : bengaluru@niralibooks.com**NAGPUR****Nirali Prakashan**Above Maratha Mandir, Shop No. 3,
First Floor, Rani Jhanshi Square,
Sitabuldi Nagpur 440012 (MAH)
Tel : (0712) 254 7129
Email : nagpur@niralibooks.com**KOLHAPUR****Nirali Prakashan**438/2, Bhosale Plaza, Ground Floor
Khasbag, Opp. Balgopal Talim
Kolhapur 416 012, Maharashtra
Mob : 9850046155
Email : kolhapur@niralibooks.com**JALGAON****Nirali Prakashan**34, V. V. Golani Market, Navi Peth,
Jalgaon 425001, Maharashtra
Tel : (0257) 222 0395
Mob : 94234 91860
Email : jalgaon@niralibooks.com**SOLAPUR****Nirali Prakashan**R-158/2, Avanti Nagar, Near Golden
Gate, Pune Naka Chowk
Solapur 413001, Maharashtra
Mobile 9890918687
Email : solapur@niralibooks.commarketing@pragationline.com | www.pragationline.comAlso find us on www.facebook.com/niralibooks

Contents ...

1. Physical Chemistry Practicals-II	1 – 90
1. Potentiometry (Any Five)	1 – 25
Experiment 1 To determine the pK_a value of a given monobasic weak acid by potentiometric titration.	3
Experiment 2 To determine the formal redox potential of Ferrous/Ferric (Fe^{+2}/Fe^{+3}) system potentiometrically.	6
Experiment 3 To determine the amount of NaCl in the given solution by potentiometric titration against silver nitrate.	10
Experiment 4 To determine the solubility product and solubility of AgCl potentiometrically using chemical cell.	13
Experiment 5 To estimate the amount of Cl^- , Br^- and I^- in the given unknown halide mixture by titrating it against standard $AgNO_3$ solution (mixture of any two ions).	15
Experiment 6 To prepare standard 0.2 M Na_2HPO_4 and 0.1 M Citric acid solutions. Prepare four different buffer solutions using them and determine the pH of these solutions as well as unknown buffer solution.	18
Experiment 7 To determine the composition of zinc ferrocyanide complex potentiometrically.	20
Experiment 8 To determine the standard electrode potentials of Cu and Ag electrodes and to determine the E.M.F. of a concentration cell.	22
2. pH Metry (Any Three)	26 – 44
Experiment 9 To determine the degree of hydrolysis of aniline hydrochloride by pH metry.	28
Experiment 10 To determine the dissociation constant of oxalic acid by pH-metric titration with strong base.	30
Experiment 11 To determine dissociation constant (pK_a) of given weak acid by pH metry by titrating it with strong base.	33
Experiment 12 To determine the acid and base dissociation constant of an amino acid and hence the isoelectric point of an acid.	37
Experiment 13 pH metric titration of strong acid against strong base by pH measurement and hence determine the concentration and strength of strong acid.	41

3. Radioactivity (Any One)	45 - 49
Experiment 14 To determine the plateau voltage of a given G.M. counter.	45
Experiment 15 To determine the resolving time of the G.M. counter.	47
Experiment 16 To determine E_{\max} of beta particles.	48
4. Colligative Properties (Any One)	50 - 67
Experiment 17 To determine the molecular weight of a given solute by depression of freezing point.	52
Experiment 18 To study the association of benzoic acid in benzene by Beckmann's method (freezing point depression).	58
Experiment 19 To determine the molecular weight of a given non-electrolyte and electrolyte by Landsberger's method and to study the abnormal molecular weight of an electrolyte.	64
5. Turbidometry (Any One)	68 - 75
Experiment 20 (a) To determine the amount of SO_4^{2-} ion by Calibration Curve Method.	68
Experiment 20 (b) Determination of Cl^- by Turbidimetric titration method.	70
Experiment 21 To determine the molecular weight of a given polymer by turbidometry.	72
6. Table Work	76 - 84
Experiment 22 Analysis of crystal structure from X-ray diffraction spectra of any two compounds (Calculation of d, lattice constant, crystal volume and density, and assigning planes to peaks using JCPDS data).	76
Appendices	85 - 90
2. Inorganic Chemistry Practicals-II	91 - 154
1. Volumetric Estimations (Any Three)	91 - 114
Experiment 23 To determine the amount of Phosphate (PO_4^{3-}) from fertilizer sample by volumetric method.	91
Experiment 24 To estimate iodine from iodized salt.	96
Experiment 25 Strength of Medicinal H_2O_2	100
Experiment 26 Analysis of calcium from milk powder.	106
Experiment 27 Estimation of Cu(II) from Cu-Fungicide.	111

2. Flame Photometry Analysis (Any Three)	115 – 126
Experiment 28 To determine the concentration of given unknown samples of Na by flame photometry using calibration curve method.	117
Experiment 29 To determine the concentration of given unknown samples of Na by flame photometry using least square (regression analysis) method.	120
Experiment 30 To determine the concentration of given unknown samples of K by flame photometry using calibration curve method.	122
Experiment 31 To determine the concentration of given unknown samples of K by flame photometry using least square (regression analysis) method.	125
3. Column Chromatography (Any One)	127 – 129
Experiment 32 Purification of water using cation/anion exchange resin and analysis by qualitative analysis/conductometry.	127
4. Nanomaterial Synthesis (Any One)	130 – 135
Experiment 33 Synthesis of Silver (Ag) nanoparticles. Perform absorbance spectra of these nanomaterials and calculate its band gap.	131
Experiment 34 Synthesis of zinc oxide nanoparticles by precursor method. Perform absorbance spectra of these nanomaterials and calculate its band gap.	133
5. Verification of Periodic Trends	136 – 138
Experiment 35 Verification of periodic trends using solubility of alkaline earth metal hydroxides $\text{Ca}(\text{OH})_2$, $\text{Mg}(\text{OH})_2$, $\text{Cr}(\text{OH})_2$, $\text{Ba}(\text{OH})_2$.	136
6. (a) Synthesis of Amine Complexes of Ni(II)	139 – 142
Experiment 36 Synthesis of amine complexes of Ni(II) and its ligand exchange reaction (bidentate ligands like acac, DMG, Glycine) by substitution method.	139
6. (b) Metal to Ligand Ratio	143 – 146
Experiment 37 To determine the metal to ligand ratio of $\text{K}_3[\text{Fe}(\text{C}_2\text{O}_4)_3] \cdot 3\text{H}_2\text{O}$ by titrimetric analysis.	143
7. (a) Solvent Free Microwave Assisted One Pot Synthesis	147 – 149
Experiment 38 Synthesis of phthalocyanine copper(II) complex by green chemistry method using MW synthesizer.	147
7. (b) Fenton's Process	150 – 152
Experiment 39 To study the decolorization / mineralization of dye solution by homogeneous catalysis by Fenton's process.	150

8. Table Work		153 – 153
Experiment 40	To determine the band gap of given nanoparticle material using UV Visible spectrophotometer.	153
Appendix		154 – 154
3. Organic Chemistry Practicals-II		155 – 176
1. Interpretation of IR and NMR Spectra (2 Experiments of Each Type)		155
2. Organic Estimations (Any Three)		176 – 186
Experiment 41	To determine the amount of glucose in the given solution by hypoiodite method.	177
Experiment 42	To determine the amount of glycine by formal titration method (Sorensen's method).	179
Experiment 43	To determine the saponification value of oil.	182
Experiment 44	To determine the amount of alkali content in antacid using HCl.	183
3. Organic Extractions (Any Three)		187 – 194
Experiment 45	To extract Caffeine from tea leaves.	187
Experiment 46	To extract Eugenol from cloves.	188
Experiment 47	To extract Lycopene from tomato peels.	190
Experiment 48	To extract Cinnamaldehyde from cinnamon.	192
Experiment 49	To extract Trimyristin from nutmeg.	193
4. Column Chromatography		195 – 201
Experiment 50	Separation of mixture of salicylic acid and salicylaldehyde by column chromatography.	197
Experiment 51	Separation of mixture of ortho and para nitro phenol by column chromatography.	199
Appendix		202 – 204

~ ~ ~

59. CH-510B: Polymer Chemistry (CBCS)

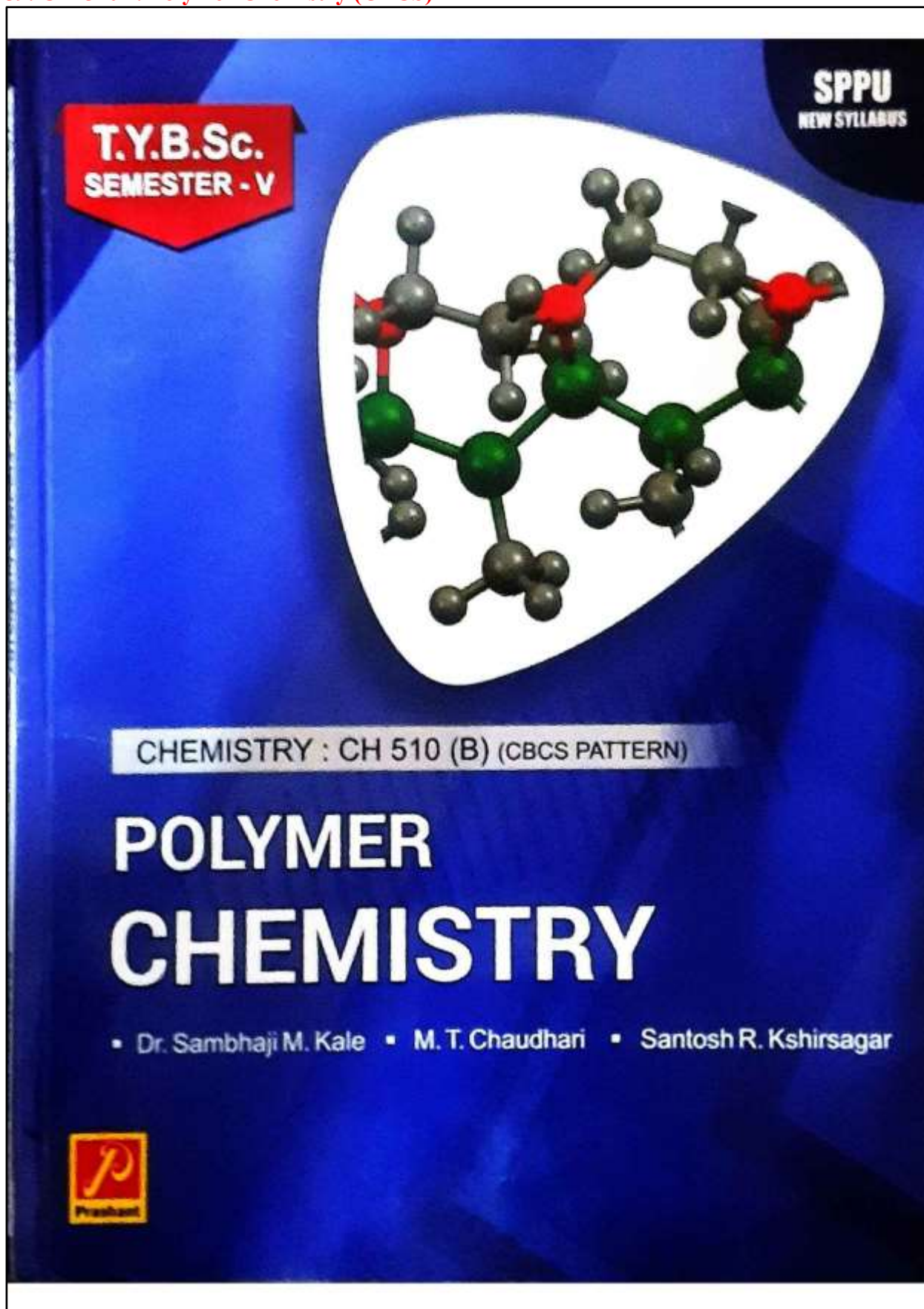

As per U.G.C. Guidelines and also on the basis of revised syllabus of
Savitribai Phule Pune University, Pune
with effect from June, 2021, Also useful for all Universities.

T.Y.B.Sc. | Sem V | CH-510 (B)

POLYMER CHEMISTRY

- A U T H O R S -

DR. SAMBHAJI M. KALE

New Arts, Commerce and
Science College,
Parner, Dist. Ahmednagar.

M. T. CHAUDHARI

GDM Arts, KRN Commerce, and
MD Science College,
Jamner, Dist. Jalgaon.

SANTOSH R. KSHIRSAGAR

Rayat Shikshan Sanstha's
Dada Patil Mahavidyalaya, Karjat, Dist. Ahmednagar.



SPECIMEN COPY

Prashant Publications



**Prashant
Publications**

© Reserve

POLYMER CHEMISTRY
T.Y.B.Sc. | Sem V | CH-510 (B)

Publisher and Printer

Prashant Publications

3, Pratap Nagar, Shri Sant Dnyaneshwar Mandir Road,
Near Nutan Maratha College, Jalgaon 425001.

• Phone • Website • E-mail

(0257) 2235520, 2232800

www.prashantpublications.com

prashantpublication.jal@gmail.com

• First Edition • ISBN • Type Setting

September, 2021

978-93-91391-98-0

Prashant Publication

Price : ₹ 130/-

e-Books are available online at www.prashantpublications.com

 **Prashant Publications** app for e-Books
kopykitab.com • amazon.com • play.google.com

All rights reserved. No part of this publication may be reproduced, stored in a retrieval system or transmitted, in any form or by any means, electronic, mechanical, photocopying (xerox copy), recording or otherwise, without the prior permission.

ii

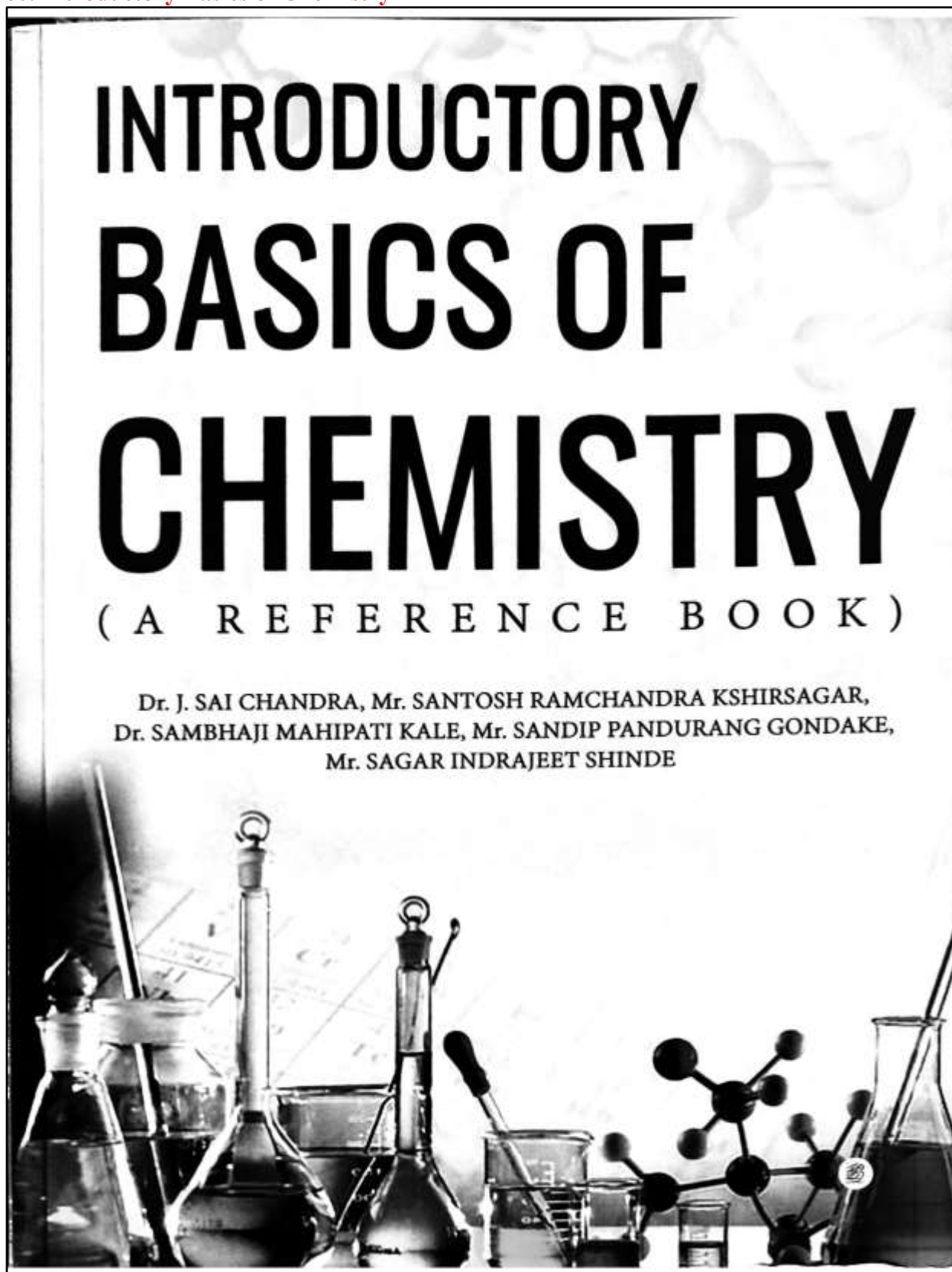
60. Introductory Basics of Chemistry

INTRODUCTORY BASICS OF CHEMISTRY

(A Reference Book)

BFC PUBLICATIONS

BFC PUBLICATIONS

Published in India by BFC Publications Private Limited
CP-61, Viraj Khand, Gomti Nagar,
Lucknow-226010, Uttar Pradesh, India

www.bfcpublications.com

ISBN – 978-93-5509-928-0

Copyright (©) – Dr. J. Sal Chandra, Mr. Santosh Ramchandra Kshirsagar
Dr. Sambhajl Mahlpatl Kale, Mr. Sandlp Pandurang Gondake
Mr. Sagar Indrajeet Shinde (2022)

All rights reserved worldwide.

No part of this publication may be copied, reproduced, stored in a retrieval system or transmitted in any form, or by any means (electronic, digital, photocopying, recording or otherwise) without the prior permission of the publisher.

Disclaimer

This is a work of fiction, and all characters and incidents narrated herein are a product of the author's imagination. Any resemblance to actual persons, living or dead, and entities is entirely coincidental.

The views expressed in this book are solely those of the author, and presented by the publisher in good faith.

CONTENTS

1. MEASUREMENT	5
2. ELEMENTS, COMPOUNDS, AND MIXTURES	9
3. STOICHIOMETRY	17
4. GASES	25
5. THERMOCHEMISTRY	50
6. AN INTRODUCTION TO IONIC COMPOUNDS	58
7. THE COVALENT BOND	73
8. THE CHEMISTRY OF NONMETALS	115
9. ACIDS AND BASES	149
10. THE STRUCTURE OF SOLIDS	188
11. AN INTRODUCTION TO KINETICS AND EQUILIBRIA	207
12. ACID-BASE EQUILIBRIA	228
13. SOLUBILITY AND COMPLEX-ION EQUILIBRIA	260
14. SOLUBILITY AND COMPLEX-ION EQUILIBRIA	350
15. COMBINED EQUILIBRIA	376
16. ELECTROCHEMISTRY	383
17. CHEMICAL THERMODYNAMICS	402
18. CHEMICAL KINETICS	421
19. CHEMICAL REACTIONS AND KINETICS	428
20. INTRODUCTION TO ORGANIC CHEMISTRY	440
21. CONCLUSION	443

61. CH-603, 606, 609: Chemistry Practical (CBCS)

T. Y. B. Sc.

SEMESTER-VI

**NEW SYLLABUS
CBCS
2019 PATTERN**

PRACTICAL CHEMISTRY-II

CHEMISTRY (CH-603, 606, 609) : PAPER-III, VI, IX

Prof. Dr. G. S. GUGALE	Dr. V. M. SHINDE
Prof. Dr. V. D. BOBADE	Prof. Dr. P. K. CHHATTISE
Prof. Dr. A. V. NAGAWADE	Prof. Dr. R. A. PAWAR
Prof. Dr. D. R. THUBE	Prof. Dr. S. S. BORHADE
Dr. M. A. BORA	Dr. R. S. DIGGIKAR

**CBCS
2 CREDITS**

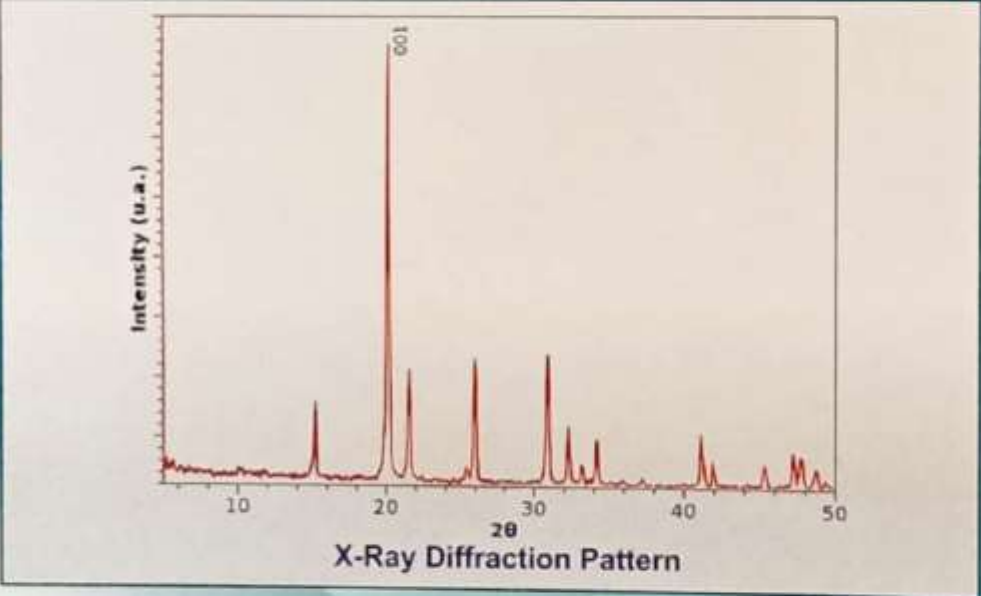

X-Ray Diffraction Pattern

**NIRALI
PRAKASHAN**
ADVANCEMENT OF KNOWLEDGE

T.Y.B.Sc. PRACTICAL CHEMISTRY-II (Sem. VI)**ISBN 978-93-5451-409-8**

First Edition : April 2022

© : Authors

The text of this publication, or any part thereof, should not be reproduced or transmitted in any form or stored in any computer storage system or device for distribution including photocopy, recording, taping or information retrieval system or reproduced on any disc, tape, perforated media or other information storage device etc., without the written permission of Authors with whom the rights are reserved. Breach of this condition is liable for legal action.

Every effort has been made to avoid errors or omissions in this publication. In spite of this, errors may have crept in. Any mistake, error or discrepancy so noted and shall be brought to our notice shall be taken care of in the next edition. It is notified that neither the publisher nor the authors or seller shall be responsible for any damage or loss of action to any one, of any kind, in any manner therefrom. The reader must cross check all the facts and contents with original Government notification or publications.

Published By :

NIRALI PRAKASHAN

Abhyudaya Pragati, 1312, Shivaji Nagar,

Off J.M. Road, Pune - 411005

Tel - (020) 25512336/37/39

Email : niralipune@pragationline.com

Polyplate

Printed By :

YOGIRAJ PRINTERS AND BINDERS

Survey No. 10/1A, Ghule Industrial Estate

Nanded Gaon Road

Nanded, Pune - 411041

DISTRIBUTION CENTRES**PUNE****Nirali Prakashan**

(For orders outside Pune)

S. No. 28/27, Dhayari Narhe Road, Near Asian College
Pune 411041, Maharashtra

Tel : (020) 24690204; Mobile : 9657703143

Email : bookorder@pragationline.com

Nirali Prakashan

(For orders within Pune)

119, Budhwar Peth, Jogeshwari Mandir Lane
Pune 411002, Maharashtra

Tel : (020) 2445 2044; Mobile : 9657703145

Email : niralilocal@pragationline.com

MUMBAI**Nirali Prakashan**Rasdhara Co-op. Hsg. Society Ltd., 'D' Wing Ground Floor, 385 S.V.P. Road
Girgaum, Mumbai 400004, Maharashtra

Mobile : 7045821020, Tel : (022) 2385 6339 / 2386 9976

Email : niralimumbai@pragationline.com

DISTRIBUTION BRANCHES**DELHI****Nirali Prakashan**Room No. 2 Ground Floor
4575/15 Omkar Tower, Agarwal Road
Darya Ganj, New Delhi 110002
Mobile : 8555778814/9818561840
Email : delhi@niralibooks.com**BENGALURU****Nirali Prakashan**Maltri Ground Floor, Jaya Apartments,
No. 99, 6th Cross, 6th Main,
Malleswaram, Bengaluru 560003
Karnataka; Mob : 9686821074
Email : bengaluru@niralibooks.com**NAGPUR****Nirali Prakashan**Above Maratha Mandir, Shop No. 3,
First Floor, Rani Jhanshi Square,
Sitabuldi Nagpur 440012 (MAH)
Tel : (0712) 254 7129
Email : nagpur@niralibooks.com**KOLHAPUR****Nirali Prakashan**438/2, Bhosale Plaza, Ground Floor
Khasbag, Opp. Balgopal Talim
Kolhapur 416 012, Maharashtra
Mob : 9850046155
Email : kolhapur@niralibooks.com**JALGAON****Nirali Prakashan**34, V. V. Golani Market, Navi Peth,
Jalgaon 425001, Maharashtra
Tel : (0257) 222 0395
Mob : 94234 91860
Email : jalgaon@niralibooks.com**SOLAPUR****Nirali Prakashan**R-158/2, Avanti Nagar, Near Golden
Gate, Pune Naka Chowk
Solapur 413001, Maharashtra
Mobile 9890918687
Email : solapur@niralibooks.com

marketing@pragationline.com | www.pragationline.com

Also find us on  www.facebook.com/niralibooks

Contents ...

1. Physical Chemistry Practicals-II	1 – 90
1. Potentiometry (Any Five)	1 – 25
Experiment 1 To determine the pK_a value of a given monobasic weak acid by potentiometric titration.	3
Experiment 2 To determine the formal redox potential of Ferrous/Ferric (Fe^{+2}/Fe^{+3}) system potentiometrically.	6
Experiment 3 To determine the amount of NaCl in the given solution by potentiometric titration against silver nitrate.	10
Experiment 4 To determine the solubility product and solubility of AgCl potentiometrically using chemical cell.	13
Experiment 5 To estimate the amount of Cl^- , Br^- and I^- in the given unknown halide mixture by titrating it against standard $AgNO_3$ solution (mixture of any two ions).	15
Experiment 6 To prepare standard 0.2 M Na_2HPO_4 and 0.1 M Citric acid solutions. Prepare four different buffer solutions using them and determine the pH of these solutions as well as unknown buffer solution.	18
Experiment 7 To determine the composition of zinc ferrocyanide complex potentiometrically.	20
Experiment 8 To determine the standard electrode potentials of Cu and Ag electrodes and to determine the E.M.F. of a concentration cell.	22
2. pH Metry (Any Three)	26 – 44
Experiment 9 To determine the degree of hydrolysis of aniline hydrochloride by pH metry.	28
Experiment 10 To determine the dissociation constant of oxalic acid by pH-metric titration with strong base.	30
Experiment 11 To determine dissociation constant (pK_a) of given weak acid by pH metry by titrating it with strong base.	33
Experiment 12 To determine the acid and base dissociation constant of an amino acid and hence the isoelectric point of an acid.	37
Experiment 13 pH metric titration of strong acid against strong base by pH measurement and hence determine the concentration and strength of strong acid.	41

3. Radioactivity (Any One)	45 - 49
Experiment 14 To determine the plateau voltage of a given G.M. counter.	45
Experiment 15 To determine the resolving time of the G.M. counter.	47
Experiment 16 To determine E_{\max} of beta particles.	48
4. Colligative Properties (Any One)	50 - 67
Experiment 17 To determine the molecular weight of a given solute by depression of freezing point.	52
Experiment 18 To study the association of benzoic acid in benzene by Beckmann's method (freezing point depression).	58
Experiment 19 To determine the molecular weight of a given non-electrolyte and electrolyte by Landsberger's method and to study the abnormal molecular weight of an electrolyte.	64
5. Turbidometry (Any One)	68 - 75
Experiment 20 (a) To determine the amount of SO_4^{2-} ion by Calibration Curve Method.	68
Experiment 20 (b) Determination of Cl^- by Turbidimetric titration method.	70
Experiment 21 To determine the molecular weight of a given polymer by turbidometry.	72
6. Table Work	76 - 84
Experiment 22 Analysis of crystal structure from X-ray diffraction spectra of any two compounds (Calculation of d, lattice constant, crystal volume and density, and assigning planes to peaks using JCPDS data).	76
Appendices	85 - 90
2. Inorganic Chemistry Practicals-II	91 - 154
1. Volumetric Estimations (Any Three)	91 - 114
Experiment 23 To determine the amount of Phosphate (PO_4^{3-}) from fertilizer sample by volumetric method.	91
Experiment 24 To estimate iodine from iodized salt.	96
Experiment 25 Strength of Medicinal H_2O_2	100
Experiment 26 Analysis of calcium from milk powder.	106
Experiment 27 Estimation of Cu(II) from Cu-Fungicide.	111

2. Flame Photometry Analysis (Any Three)	115 – 126
Experiment 28 To determine the concentration of given unknown samples of Na by flame photometry using calibration curve method.	117
Experiment 29 To determine the concentration of given unknown samples of Na by flame photometry using least square (regression analysis) method.	120
Experiment 30 To determine the concentration of given unknown samples of K by flame photometry using calibration curve method.	122
Experiment 31 To determine the concentration of given unknown samples of K by flame photometry using least square (regression analysis) method.	125
3. Column Chromatography (Any One)	127 – 129
Experiment 32 Purification of water using cation/anion exchange resin and analysis by qualitative analysis/conductometry.	127
4. Nanomaterial Synthesis (Any One)	130 – 135
Experiment 33 Synthesis of Silver (Ag) nanoparticles. Perform absorbance spectra of these nanomaterials and calculate its band gap.	131
Experiment 34 Synthesis of zinc oxide nanoparticles by precursor method. Perform absorbance spectra of these nanomaterials and calculate its band gap.	133
5. Verification of Periodic Trends	136 – 138
Experiment 35 Verification of periodic trends using solubility of alkaline earth metal hydroxides $\text{Ca}(\text{OH})_2$, $\text{Mg}(\text{OH})_2$, $\text{Cr}(\text{OH})_2$, $\text{Ba}(\text{OH})_2$.	136
6. (a) Synthesis of Amine Complexes of Ni(II)	139 – 142
Experiment 36 Synthesis of amine complexes of Ni(II) and its ligand exchange reaction (bidentate ligands like acac, DMG, Glycine) by substitution method.	139
6. (b) Metal to Ligand Ratio	143 – 146
Experiment 37 To determine the metal to ligand ratio of $\text{K}_3[\text{Fe}(\text{C}_2\text{O}_4)_3] \cdot 3\text{H}_2\text{O}$ by titrimetric analysis.	143
7. (a) Solvent Free Microwave Assisted One Pot Synthesis	147 – 149
Experiment 38 Synthesis of phthalocyanine copper(II) complex by green chemistry method using MW synthesizer.	147
7. (b) Fenton's Process	150 – 152
Experiment 39 To study the decolorization / mineralization of dye solution by homogeneous catalysis by Fenton's process.	150

8. Table Work		153 – 153
Experiment 40	To determine the band gap of given nanoparticle material using UV Visible spectrophotometer.	153
Appendix		154 – 154
3. Organic Chemistry Practicals-II		155 – 176
1. Interpretation of IR and NMR Spectra (2 Experiments of Each Type)		155
2. Organic Estimations (Any Three)		176 – 186
Experiment 41	To determine the amount of glucose in the given solution by hypoiodite method.	177
Experiment 42	To determine the amount of glycine by formal titration method (Sorensen's method).	179
Experiment 43	To determine the saponification value of oil.	182
Experiment 44	To determine the amount of alkali content in antacid using HCl.	183
3. Organic Extractions (Any Three)		187 – 194
Experiment 45	To extract Caffeine from tea leaves.	187
Experiment 46	To extract Eugenol from cloves.	188
Experiment 47	To extract Lycopene from tomato peels.	190
Experiment 48	To extract Cinnamaldehyde from cinnamon.	192
Experiment 49	To extract Trimyristin from nutmeg.	193
4. Column Chromatography		195 – 201
Experiment 50	Separation of mixture of salicylic acid and salicylaldehyde by column chromatography.	197
Experiment 51	Separation of mixture of ortho and para nitro phenol by column chromatography.	199
Appendix		202 – 204

~ ~ ~

Articles in Proceeding (P): 2017-2018 to 2021-2022

1. Prachin Va Madhyugin Newase

अनुक्रमणिका			
अ.क्र.	शोधनिबंधक	संशोधकाचे नाव	पृष्ठ क्र.
१	Marginalization: Theory Concept and Development	डॉ. दिपक गायकवाड	१-८
२	शेतकरी चळवळीत शेतकरी संघटनेची भूमिका आणि आजची परिस्थिती	डॉ. के. एम. अंबाडे	९-१३
३	कोल्हापूर एक आदिवासी जमात	डॉ. ए. के. भुजुळकर	१४-१७
४	स्थानिक इतिहास लेखन व महत्त्व	डॉ. एन. आर. मोकाटे	१८-२२
५	आधुनिक पिंपरी चिंचवडच्या इतिहासात आपणासाहेब भगर याचे योगदान	डॉ. एस. एस. काळभोर	२३-२६
६	Colonial Approach to Indian History and Historiography	डॉ. रघुनाथ शेळके	२७-३७
७	उत्तरी राजर्षी शाहूचे वंशितांच्या उदारातील योगदान	डॉ. व्ही. एस. गोर्डे	३८-४३
८	केळूगण गावचा इतिहास	डॉ. आर. आर. सोनवणे	४४-४८
९	स्वतंत्रपूर्व काळातील कामगार चळवळीची वाटचाल	डॉ. एच. वाय. गायकवाड	४९-५२
१०	सेनापती दाभाडे घराण्याची मराठ्यांच्या इतिहासातील उपेक्षित एक अभ्यास	डॉ. एस. के. भामरे	५३-५७
११	महात्मा फुले यांची शैक्षणिक कामगिरी	डॉ. आर. एम. कुरुमकर	५८-६२
१२	श्रीगाँद्याचा ऐतिहासिक अभ्यास	डॉ. एम. एम. जगदाळे	६३-७०
१३	भिमथडीच्या शेतकरी बंडाचा ज्ञात अविष्कार	डॉ. डी. ए. मोरे	७१-७३
१४	शेवगाव तालुक्याचा स्थानिक इतिहास	डॉ. एस. एन.मिरे , प्रा. एच.एन.जमाले	७४-८३
१५	महर्षी विठ्ठल रामजी शेतक-यांसाठीचे कार्य व आर्थिक धोरण	डॉ. मीना साळे	८४-८५
१६	कामगार चळवळ आणि नारायण मेघाजी लोखंडे	प्रा. बी. जे. काकडे	८६-८९

१७	दुसऱ्या महायुद्धाच्या काळातील सोलापूर शहरातील हातमाग कामगारांच्या चळवळी	प्रा. ए. डी. केत	१०-१७
१८	स्त्रियांचे हक्क व त्यांचे अधिकार डॉ बाबासाहेब आंबेडकर	प्रा. अर्जुन चाटे	१८-१००
१९	वंचितांचे समाजसुधारक महर्षी विठ्ठल रामजी शिंदे	प्रा. हरीश शेळके	१०१-१०७
२०	उत्खनन स्थळ इनामगाव	प्रा. एस. व्ही. गागरे	१०८-११०
२१	जुन्नर तालुक्यातील महादेव कोळी समाजाचे उठाव	प्रा. शांता गडगे	१११-११३
२२	आदिवासी धर्मातील विधी स्थळ, काळ व भाषा	प्रा. एल. बी. काकडे	११४-११६
२३	भारतातील आदिवासी चळवळीचा अभ्यास	प्रा. प्रकाश गावित	११७-१२०
२४	पुणे नगरपालिकेतील ज्योतीराव फुले यांचे योगदान	के. ए. भानवसे	१२१-१२६
२५	रानाप्रणीत संवादी इतिहास लेखन प्रवाह	ए. एल. भालसिंग	१२७-१३१
२६	प्राचीन मध्ययुगीन नेवासे	डॉ. वेंगळी भालसिंग, प्रा. ए. टी. गंडाळ	१३२-१३८
२७	वंचितांच्या दृष्टिकोनातून घिसाडी जमातीचे चिकित्सक विवेचन	प्रा. के. एस. पवार	१३९-१४४
२८	INTERPRETATIONS OF Indian History: COLONICAL Nationalist AND Post Colonial	प्रा. संदिप शिरसाठ	१४५-१५१
२९	History of Ahmednagar	प्रा. व्ही. एस. पानसरे	१५२-१५४
३०	राष्ट्रवीर: साप्ताहिक एक उपेक्षित ऐतिहासिक विचारधन	प्रा. विशाल रोकडे	१५५-१५८
३१	ब्रिटिश कालीन पेट तालुक्यातील (नाशिक) डांग सेवा मंडळाचा सामाजिक योगदानाचा अभ्यास	प्रा. एस. व्ही. पोतदार	१५९-१६३
३२	आधुनिक महाराष्ट्रातील मानसिक, वंचित इतिहास: एक स्त्री	प्रा. वंदना घोडके	१६४-१६९
३३	इतिहास लेखनातील नववनीन विचार प्रवाह व दृष्टिकोन यांचे चिकित्सक मुल्यमापन	प्रा. प्रा. सचिन कांबळे	१७०-१७३

प्राचीन व मध्ययुगीन नेवासे

डॉ. वैशाली भालसिंग,
गंडाळ आबासाहेब तान्हाजी
सहाय्यक प्राध्यापक,
न्यू आर्ट्स कॉमर्स अॅण्ड सायन्स
कॉलेज, पारनेर

मानव आपल्या उत्क्रांतीसाठी झटत असतो. विज्ञानाचे किंवा नैसर्गिक शास्त्राचे शोधत असतो किंवा आपल्या उत्क्रांतीसाठी करत असतो. त्यामध्ये सामाजिक शास्त्रे तरी मागे कसे राहतील? त्यांनी देखील आपआपल्या परीने त्यासाठी योगदान दिलेले आहे. सामाजिक शास्त्र इतिहास देखील मागे नाही. इतिहासात देखील नवनवीन संशोधने दिवसेंदिवस होत आहेत. इतिहासात वेगवेगळे प्रवाह येत आहेत, वेगवेगळ्या अंगांनी इतिहास अभ्यासात जात आहे. वेगवेगळ्या पद्धतींनी इतिहासाचे विश्लेषण केले जात आहे.

इतिहासाच्या दृष्टीने विचार केला तर आज अनेक नवीन प्रवाह इतिहास अभ्यासाचे आणि संशोधनाचे आपणास पाहावयास मिळतात. त्यामध्ये स्थानिक इतिहासापासून उत्तर आधुनिक इतिहासाची कारणमिमासा आपण पाहू शकतो. विचार आणि विचारातून होणारी कृती आपल्याला दुसरा विचार करण्यास भाग पाडतो. आणि त्यातून परत पुढचा विचार आपल्यापुढे येतो. हा विचार आपणास अभ्यास करण्यास भाग पाडत आहे. आणि अशा विचारातून स्थानिक इतिहास पुढे येताना आपणास दिसत आहे.

स्थानिक इतिहास प्रादेशिक व राष्ट्रीय इतिहासाचा अविभाज्य भाग आहे. स्थानिक इतिहासामुळे प्रादेशिक व राष्ट्रीय इतिहासामध्ये भर पडते. " इतिहास हा अतिशय व्यापक विषय आहे. अभ्यासाच्या सोयीसाठी वेगवेगळ्या प्रकारे त्याची विभागणी केली जाते. उदा. प्राचीन, मध्ययुगीन, आधुनिक अशी काळाच्या निष्कर्षांवर केली जाणारी विभागणी. अशीच स्थलाच्या निकषावर केली जाणारी विभागणी म्हणजे जागतिक इतिहास, राष्ट्रीय इतिहास, प्रादेशिक इतिहास आणि स्थानिक इतिहास हा प्रादेशिक विभागाचाच पोट विभाग आहे."१ कोणत्याही एका छोट्या गावाची मंदिराची, किल्ल्याची, पेठेची, किंवा व्यक्तीची माहिती गोळा करून त्याचा इतिहास लिहला जातो. तेव्हा तो स्थानिक इतिहास होय. त्याला एका विशिष्ट स्थानापुरते मर्यादित केले जाते फोकस हा विशिष्ट स्थानावरती असतो. त्यामुळे इतिहास समृद्ध होण्यास मदत होते. .

स्थानिक इतिहास हा स्थलाकडून सूक्ष्माकडे जाणारा आहे. एखाद्या विशिष्ट स्थानिक भागात जिथे राहणारे लोक त्यांच्या परंपरा राहणीमान व मुख्यतः संस्कृती तसेच मानसिकतेचा अभ्यास हा स्थानिक

इतिहासचा मुख्य गाथा आहे. म्हणूनच स्थानिक व प्रादेशिक इतिहासाच्या पायावर राष्ट्रीय इतिहासाची भौगोलिक मर्यादा लहान आहे. प्रदेश ही संकल्पना सापेक्ष आहे. स्थानिक इतिहासात गावांचा इतिहास सर्वाविष्ट केला जातो. परंतु गावाच्या 'एखाद्या भागाचा, पेटेचा किंवा एखाद्या विद्यापीठाचा इतिहास हा देखील स्थानिक इतिहास म्हणून गणला जाऊ शकतो. एखाद्या स्थानाभोवती किंवा विभागाभोवती केंद्रित राहून त्या स्थानाचे इतिहास लेखन करणे म्हणजे स्थानिक इतिहास लेखन करणे होय.' ^३

स्थानिक इतिहास हा प्रत्येक गावाला प्रत्येक परिसराला त्यात त्या गावातील ऐतिहासिक घराणे, सभागाच्या घालोरीतो, परंपरा मंदीरे त्या गावाने इतिहासात जे जे म्हणून योगदान दिलेले असेल अशा सर्व घटकांचा समावेश हा स्थानिक इतिहासात होताना दिसतो. अनेक इतिहास संशोधकांनी स्थानिक इतिहासात छोट्या गावाचा इतिहास लिहलेला दिसतो. तसाच अल्पसंख्येच्या 'नेवासे' गावाविषयी मी करत आहे.

महाराष्ट्र ही संतांची भूमी आहे हा रंगड भोंड्यांचा देश आहे. हा एकट व तापटांचा देश आहे असे अनेक उल्लेख आपणास साहित्यात महाराष्ट्राविषयी दिसतात त्यामुळे तेथील लोकांची जीवनपध्दती कष्टक-यांची जिद्द आणि साधी राहणी आपल्या लक्षात आल्याबाबत राहात नाही.

नेवासे हे गाव आधुनिक महाराष्ट्रातील अहमदनगर पासून ईशान्येला साधारण ५५ कि.मी. अंतरावर आहे. नेवासा हे आज तालुक्याचे मुख्यालय आहे. त्यावरून नेवासा तालुका हे नाव तालुक्यात दिलेले आपणास दिसून येते. १९° १९' ते १९° ४' उत्तर अक्षांश व ७४° ४८' ते ७५° ११' पूर्व रेखांशावर आज नेवासाचे स्थान आहे. हे गाव प्रवरा नदीच्या (गोदावरी नदीची उपनदी) काठावर वसलेले आहे. अगोदर हे गाव प्रवरेच्या डाव्या तीरावरती होते. परंतु नदीने मार्ग बदलल्यामुळे आज या गावाचे नदीने दोन भाग केलेले आहेत. उजव्या तीरावरील गावास नेवासे खुर्द तर डाव्या तीरावरील गावास नेवासे बुदुक असे म्हणतात. नेवासे खुर्द हे आज लोकसंख्येच्या दृष्टीने मोठे आहे. परंतु अंतराच्या दृष्टीने फक्त नदी मध्ये असल्यामुळे फारसा फरक जाणवत नाही. परंतु प्राचीन अवशेष हे जास्त नेवासा बु. येथे पहावयास मिळतात.

नेवासा या गावास तशी मोठी इतिहास परंपरा आहे. प्राचीन (इतिहास पूर्व काळापासून) ते अर्वाचिन काळापर्यंत नेवासाचा इतिहास पहावयास मिळतो. काही कागदपत्रांची कमतरता आणि नदीने मार्ग बदलल्यामुळे झालेल्या आलल्या ऐतिहासिक अवशेषांचे खंडन या बाबी मात्र इथे प्रभाव पाडतात. नेवासाच्या इतिहासाचे (प्राचीन व मध्ययुगीन) आपण दोन भागात विश्लेषण करू शकतो.

➤ प्राचीन नेवासे:-

प्राचीन वाडःमयात कोरीव लेखात याचे उल्लेख मिळतात. ते निधीनावास, निधवास, निवास अशा भिन्न नावांनी आहेत. नेवासे येथे लाडमोड टेकाडात डेकुन कॉलेजच्या वतीने स.१९५४ ते १९६० या काळात डॉ. सांकलिया व डॉ. हरावती कर्वे यांनी उत्खनन केलेले आहे. त्यामध्ये अनेक पुरातनवस्तु सापडलेल्या आहेत. इ.स.पुर्व दुस-या दशकात तेथे वस्ती झाली होती. हे आपणास त्यावरून दिसून येते. ताम्रपाषाण संस्कृतीच्या काळातील हे लोक असून ते जोवं संस्कृतीचे लोक आहेत. हे लोक तांब्याच्या कु-हाडी छत्र्या व मासे पकडण्याचे गळ वापरत असत. त्याच बरोबर दगडाची घासून गुळगुळीत केलेली नव, आश्मयुगी साधने देखील आढळून आलेली आहेत. काळ्या रंगाची नक्षी काढलेली भांडी, कळशा आणि मातीचे तवे येथील लोक वापरत असत. मणी देखील तीथे सापडलेले आहेत. “नेवासा वासियांच्या(तेथिल रहिवाशांच्या) जीवनात रोमन बनावटीच्या अनेक वस्तू जसे मोठ मोठाले मद्य, कुंभ, रोमन, काचेचे मणी अचंणा कुंडे इ. हया मिळाल्या आहेत.”^१ या वरून त्यांचा व्यापारी संबंध ह्य रोमशी होता असे प्रथम दर्शनी वाटते. “नेवाशाच्या उत्खननात महाराष्ट्रातील ताम्रपाषाण संस्कृतीचा प्रस्तुत पुरावा पहिल्या प्रथम हाती येऊन या लोकांचा नवअश्मयुगीन लोकांशी निकटचा संबंध आला आहे हे उघड झाले.”^२

आजच्या नेवासा सा गावास निधीनिवास, निवास, महालय अशी नावे आढळतात. ही नावे कशी पडली व पुढे त्याचे नेवासा कसे झाले हे वेगवेगळ्या कथेतून समजते. “नेवासा संबंधी शिलालेख सापडणारा पहिला उल्लेख नऊरगाव येथील यादव रामचंद्र देव यांच्या शके १२०० (इ.स.१२७८) च्या शिलालेखात सापडतो.” * त्याच प्रमाणे नेवासाला महालय देखील म्हणत असत. त्याच्या देखील वेगळ्या कथा आहेत.

“महानुभवाच्या स्थापना पोथीत नेवासा चे वर्णन आलेले आहे. नेवासा गाव पुर्वी फार लहान होते. या गावाजवळ ‘माळी मोहतर्क’ म्हणून दुसरे लहान गाव होते. या दोन्ही गावापसून पाव मैल अंतरावर ‘लाडमोड’ हे गाव होते.”^३ (लाडमोड हे यादवांच्या काळात महसूल गोळा करण्याचे ठिकाण म्हणून नमुद आहे.) पुढे या तीन्ही गावांचे मिळून नेवासा नदीच्या प्रवाह बदलामुळे परत त्याचे नेवासा खुर्द आणि नेवासा बुद्रुक ही दोन गावे तयार झाली. या गावाचा उल्लेख स्केध पुराणात व माधत कर्तीच्या काव्यात आपणास मिळतात याला पौराणिक अग्न्यान देखील आहेत. “डोमेग्राम हुन निधीनिवास मार्गी चाचर मुनी असना डो मेगावाहुन नेवासेला जात. श्री घक्रधर चाचरमुनी मुक्काम क्षणभर करत होते.”^४ असा उल्लेख लिळा चरित्रात देखील आलेला आहे.

पुराण कथेनुसार कुबेराच्या निधीचा वास तो निर्भीनिवास असे महात्म्य आहे. तारकासुरास भिऊन राहणा-यास सुरक्षीत ठिकाणी देवांनी मागुण घेतले तेव्हा गोदावरीच्या जवळ व प्रवरेच्या काटावर जागेवो शिफारस विष्णुनी केली. व कुबेर आपले नऊ कोप घेऊन इथे राहिला. अशी अख्यायिका आहे.

नेवासेचे नाव महालय आहे. त्यावरून दिसते त्याच प्रमाणे 'ज्ञानेश्वरीत' (भावार्थदिपीका) मिळणा-या अल्लेखावरून देखील सिध्द होते.

एसी युगी वरि काळी | आणि महाराष्ट्र मंडळी |

श्रीगोदावरीच्या कुळी | दविणिता ||

येथे भुवनेक पवित्र | अनादी पंचकोप क्षेत्र |

जगचे जीवनसुत्र | जेथे श्री मळस |

श्रीज्ञानेश्वरी, अध्याय १८ चा ओवी १७८१मध्ये असा उल्लेख देखील आपणांस मिळतो. याला जोड म्हणुन स्कंध पुराणानुसार समुद्रमंथनाची अमृत वाटपाची कथा देखील सांगितली जाते. आणि त्यावेळां निघालेल्या १४ रत्नापैकी अमृताचे वाटप नेवासात प्रवारातीरी झाल्याचे सांगितले जाते. त्यावेळेस विष्णुने मोहनीचे रूप घेतले होते. त्या मोहनीराजाचे मंदिर हे नेवासात आहे. (नेवास खुर्द) तर खंडोबांची पत्नी म्हाळसा हिचे माहेर देखील नेवाशात आहे. (नेवासा बुद्रुक येथे खंडोबाचे मंदिर आहे. तेव्हा नेवासा खुर्दास मोहणिराजाचे नेवासे असे नामभिज्ञ देखील आहे. तेव्हा नेवासा खुर्दास मोहणिराजाचे नेवासे आणि नेवासे बुद्रुकास खंडोबाचे नेवासे नामभिज्ञ देखील आहे. असे एक ना अनेक उल्लेख साहित्यात आणि विशेष करुन वैदिकसाहित्य आणि महानुभव साहित्यामध्ये प्राचीन नेवाशाचे आपणास उल्लेख मिळतात. पण राज्य स्थापणे विषयी माहिती हि यादव काळापासुन पराव्यादाखल मिळते.

प्राचीन व्यापार बंधितल्यास नाणे घाट जुन्नर, आळे नेवासे मार्ग प्रतिष्ठान (आजचे पैठण) असा व्यापारी मार्ग होता. त्यामुळे प्राचीन काळात देखील व्यापारात नेवासे अग्रेसर होते. लाडमोड टेकडावरील झालेल्या उत्खननात देखील तशा रोमशी व्यापारात पुसटश्या खुणा आपणास दिसतात हे महत्वाचे आहे. परंतु मध्ययुगात मात्र एक व्यापारी पेट म्हणून नेवासा तितका पुढे आलेला आपणास दिसत नाही.

➤ मध्ययुगीन नेवासे-

दक्षिणेतील काशी म्हणजे निर्धनीवास नेवासे हे महाराष्ट्रातील यादव राजांचे केंद्र होते. आणि महाराष्ट्रातील थोर संत ज्ञानेश्वर विठ्ठलपंत कुलकर्णी यांनी ज्ञानेश्वरी देखील येथेच सांगितलेली आहे. तिचे लिखाण नेवासा येथील रहिवाशी सचिनानंदबाबा कुलकर्णी १८ व्या अध्यायातील शेंवटची ओळी खूप बोलकी आहे.

शके बाराशे बारातरे | वैदिका केली ज्ञानेश्वरे | सचिनानंदबाबा आदरे | लेखक जहाला | म्हाळसा मोहणीराज मंदिरामुळे हे तिर्य क्षेत्र विशेष प्रसिध्दीस आले आहे. शिवभारत कर्ता कविंद्र परमानंद हा निर्धनीवासकार (नेवासकर) होय.

“औरंगजेबाच्या कैदेत असताना छत्रपती संभाजी पुत्र छत्रपती शाहुंचे लग्न औरंगजेबाने लावून दिले. त्या वेळेस त्याने हा भाग शाहुला लग्नात आंदण म्हणून दिला होता. कैदेतून सुटून आल्यावर शाहुने प्रथम आपला अमल या भागावर सुरु केला”^{११} अगोदर हा भाग यादवांच्या काळात यादवाच्या अमलाखाली होता व त्यानंतर तो पुन्हा शाहुच्या रुपाने मराठ्यांच्या अमलाखाली आला. मधल्या काळात अगोदर निजामशाहीत हा भाग समाविष्ट होता. परंतु निजामशाही बुडाल्याने नंतर तो भाग मोघलांच्या ताब्यात आला. मोघलांकडून परत मराठ्यांकडे त्याचा प्रवास झाला इ. स. १७२४ नंतर हा प्रांत हेद्राबादच्या निजामाने घेतला उदगीरच्या लढाईच्या वेळी इ. स. १७६० मध्ये पेशव्यांचा अंमल या ठिकाणी आला. पेशव्यांचा सुबेदार नारें बाजी नगरकर याने या भागाची पूर्णरचना (प्रशासकीय) केली.

शाहु नंतर पेशवे सर्वसत्ताधिश बनले पेशव्यांच्या काळात इ. स. १७६० ला हा भाग होळकरांकडे आला तो इ.स. १८०० पर्यंत नंतर इ. स. १८०० ला तो ब्रिटीशांनी ताब्यात घेतलेला दिसतो. म्हणजे होळकर सोडून दिर्घकाळ या प्रदेशावर कोणाचेही राज्य मध्ययुगात राहिलेले आपणास दिसून येत नाही.

निजामशाही राज्या जेव्हा शहाजी भोसले काम करत होते. तेव्हा त्यांचा देखील सहवास नेवासाला लाभल्याचे दिसते. त्याच बरोबर मलिक अंबरने आपली प्रतवारी पध्दती (जमिन महसुलाची) देखील येथे राबवलेली आपणांस दिसते. मध्ययुगीन नेवासात औरंगजेबाचे देखील वास्तव्य काही काळ झाले होते. नेवासा व. येथे असणारे नारद मुनींचे मंदीर (जगाच्या पाठीवर इतरत्र कोठेही नारदमुनींचे मंदीर नाही असा समज आहे) त्याने पाडले व त्याच भग्न अवशेषांचे परत दुसरे मंदीर बांधलेले आहे. ते आज च-यांपैकी स्थितीत आहे पण तेथे कबर आहे. परंतु हिंदूंची घंटा देखील तिथे पहावयास मिळते. दुसरी काही खूण नाही हिंदू च मुसलमान तेथे मनोभावे पूजा करतात जेव्हा अहमदनगर या ठिकाणी औरंगजेब मृत पावला तेव्हा त्याचा मृतदेह औरंगाबादहून येताना नेवासा येथे टेकवला होता. त्या ठिकाणी तकीया म्हणतात तेथे एक पिराचे टाणे

आजही पहावयास मिळते. तेथील व्यवस्था पाहण्यासाठी एका मुस्लिम व्यक्तीला ६ एकर जमिन दिली होती. आज त्याने ती त्याचा मालकीची करून घेतली आहे.

प्रवरा नदीच्या काठावर गणपती, घाघ-या घाट आहेत हे घाट होळकरांनी बांधलेले आहेत. त्याचप्रमाणे घाघ-या घाटावर प्राचीन महादेवाचे मंदीर आहे. त्यात एका वेळेस एकच माणूस जाऊ शकेल अगदी तेवढेसे ते मंदिर आहे. मोहणीराजाचे जे जुने मंदीर होते (त्याला पाकशाळा असे संबोधले जात असत) ते प्रवरा तीरावर होते. ती पाकशाळा पाहून ट्रस्टने तिथे दुसरी इमारत बांधलेली आहे.

नेवासेत अतिशय चांगल्या स्थितीत असलेले सध्याचे मोहनिराजाचे मंदिर हे होळकरांचे सरदार गंगाधर यशवंत चंद्रचुड यांनी बांधलेले आहे. (चंद्रचुडांना नेवासा परिसरातील २२ गावे जहागिरी म्हणून होळकरांनी दिलेली होती) मंदिरासाठी चार हजार कामगार चार ते सहा वर्षे काम करत होते चार ते पाच लक्ष रुपये खर्च झाला. पेशव्यांनी दर साल १५०० रुपये वार्षिक अनुदान दिले होते. ते १८६० पर्यंत मिळत होते. या मंदिराचे पूर्ण काम इ.स. १७७४ साली पूर्ण झाले. इनाम कमिशनने १८६१ ला अनुदान बंद केले ब्रिटीश सरकारने २४८ रुपये अनुदान प्रतिवर्षी देण्यास सुरुवात केली. सध्याचा खर्च देवस्थानाच्या जमिनीतून व इतर मिळकतीतून केला जातो. या मंदिराची उंची ७५ फूट असून, मंदिराची बांधणी दगडी असून कलाकौशल्याने परीपूर्ण आहे. नाशिक येथील मंदिराच्या बांधणी प्रमाणे या मंदिराची बांधणी वाटते.

नेवासामध्ये आणखी ज्ञानेश्वराचे मंदिर देखील आहे, परंतु जुने मंदिर पाडल्यामुळे आज त्या ठिकाणी दुसरे मंदिर बांधलेले आहे. ते मंदिर एका दगडी खांबासाठी आहे. त्या खांबाला टेकून ज्ञानेश्वरांनी ज्ञानेश्वरी सांगितली असे म्हणतात. त्या खांबावर चंद्र आणि सुर्य कोरलेले आहे. त्यास पेशाचा खांब असे नामाभिष आहे. (पैस) त्याचप्रमाणे नेवासात मध्ययुगीन मशिद ह्या देवळाच्या जागेवर देवळे पाडून बांधल्या असे म्हणतात. त्या मशिदीच्या दगडावर जुणे कोरलेले नक्षीकाम देखील तसेच आहे. प्रवरानदीच्या पात्रात आपण फिरल्यास अनेक नक्षीकाम केलेले दगड आपणास आढळून येतात. त्याची माहिती मात्र मिळत नाही.

गंगाधर चंद्रचुड या होळकरांच्या सरदाराचा वाडा नेवासा बुद्रक येथे आहे. व्यापाराच्या दृष्टीकोनातून नानेघाट ते पैठण या मार्गावर नेवासे होते. यात्रा उत्सव हे वेळोवेळी भरत असत. मोहनिराजची यात्रा भरत असे. त्याचप्रमाणे नेवासा बुद्रक पासून दिड मैल अंतरावर असणा-या बहिरवाड येथे बहिरोबाची (भैरवनाथाची) यात्रा भरत असत. त्या ठिकाणी मोठे आर्थिक व्यवहार होत असत. तात्पुरती बाजारपेठ निर्माण केली जात असत. परंतु मुख्यतत्वे शोतीवरतीच भर होता आणि आजही जास्त भर हा शोतीवरतीच अवलंबून दिसतो.

इ. स. १८०० ला नेवासा हा होळकरांकडून ब्रिटीशांकडे गोल आणि त्यानंतर स्वातंत्र्य प्राप्ती पर्यंत त्यावर ब्रिटीशांचेच वर्चस्व राहिले. तेथे जवळ चढाळा येथे मिशनरी स्थापन होऊन त्याचा प्रभाव नेवासावर देखील पडलेला दिसतो. नेवासाने स्वतंत्र चळवळीत देखील आपले भरीव योगदान दिलेले आहे. त्या संबंधीची यादीच आपणास नेवासा तहसिल कचेरीत पहावयास मिळते. आज मुस्लीम व हिंदू त्याच बरोबर ख्रिश्चिनांच्या देखील वावर नेवासात आपणास दिसून येतो. समाजात असणा-या सर्व धर्मांचे उत्सव हे आनंदाने तिथे साजरे होतात.

नेवासाच्या प्राचीन व मध्ययुगीन इतिहासास संशोधनास आजून मोठ्या प्रमाणात वाव आहे. त्याचप्रमाणे त्यामुळे स्थानिक इतिहासाकडे पाहण्याचा आपला दृष्टिकोन बदलून मोठ्या प्रमाणात संशोधन होण्यास मदत होते. नेवासाच्या इतिहासामुळे आपणास जेव्हा संस्कृतीपासून मराठ्यांच्या प्रशासन व्यवस्थेपर्यंतची माहिती मिळते. मंदिरामुळे इतिहास समजण्यास मदत होते. समाजव्यवस्था समजण्यास मदत होते.



स्थानिक इतिहासात नेवासा या गावच्या इतिहासाचे महत्त्व अनन्य साधारण आहे. हे मात्र खरे

तळ टिपा

- १) प्रा. डॉ. लडू गायकवाड व डॉ. श्रीकांत फुलसुंदर, ऐतिहासिक दुर्ग नारायणगड लोक संस्कृती प्रकाशन नारायणगाव, प्रथम आवृत्ती २०१२ पृष्ठ क्र ९
- २) तर्कतिथ लक्ष्मण शास्त्री जोशी (संपादक) मराठी विश्वकोष –खंड ८ वा महाराष्ट्र राज्य सांस्कृतिक मंडळ मुंबई, प्रकाशन- १९७६ पृष्ठ क्र-९४४
- ३) किल्ला पान-९४५
- ४) प्रा. रामनाथ नन्नवरे, 'नेवासा तालुक्यातील मंदिरांचा इतिहास', एम. फिल प्रबंध (अप्रकाशित) पुणे विद्यापीठ पुणे, पृष्ठ क्र-५७
- ५) प्रा. डॉ. चंद्रकांत आभंग, 'भारत इतिहास संशोधक मंडळ' गौमासिक, पेशवे कालिन जत्रा व त्यांचे प्रशासन अंक १ ते ४ वर्ष १९९७-१९९८ पृष्ठ -१६
- ६) ६ ना नेने भारत इतिहास संशोधक मंडळ पुणे त्रैमासिक तेराव्या शतकातील नेवासे (महानुभव वाड:मयाच्या आधारे) अंक दुस-या, वर्ष-१९३८ पृष्ठ -५४
- ७) प्रा. डॉ. चंद्रकांत आभंग, भारत इतिहास संशोधक मंडळ पुणे गौमासिक, पेशवेकालिन जत्रा व त्यांचे प्रशासन", अंक १ ते ४ वर्ष १९९७-९८, पृष्ठ क्र १६

2. Kamgar Chalval Ani Narayan Meghaji Lokhande

ISBN-978-81930154-3-5

बी. सी. यु. डी. सावित्रीबाई फुले पुणे विद्यापीठ, पुणे
व
अहमदनगर जिल्हा मराठा विद्या प्रसारक समाजाचे,
न्यू आर्ट्स, कॉमर्स अँड सायन्स कॉलेज, पारनेर
आयोजित
एक दिवसीय राष्ट्रीय चर्चासत्र ५ जानेवारी, २०१८
'आधुनिक महाराष्ट्रातील वंचितांचे इतिहास लेखन'



* आयोजक *
इतिहास विभाग
न्यू आर्ट्स, कॉमर्स अँड सायन्स कॉलेज, पारनेर
जिल्हा अहमदनगर, ४१४३०२ (महाराष्ट्र)

अनुक्रमणिका

अ.क्र.	शोधनिबंदक	संशोधकाचे नाव	पृष्ठ क्र.
१	Marginatization: Theory Concept and Development	डॉ. दिपक गावकवाड	१-८
२	शेतकरी चळवळीत शेतकरी संघटनेची भूमिका आणि आजची परिस्थिती	डॉ. के. एम. अंबाडे	९-१३
३	कोलाम एक आदिवासी जमात	डॉ. ए. के. मुंजुळकर	१४-१७
४	स्थानिक इतिहास लेखन व महत्त्व	डॉ. एन. आर. मोकाटे	१८-२२
५	आधुनिक पिंपरी चिंचवडच्या इतिहासात आण्णासाहेब मगर याचे योगदान	डॉ. एस. एस. काळभोर	२३-२६
६	Colonial Approach to Indian History and Historiography	डॉ. रघुनाथ शेळके	२७-३७
७	छत्रपती राजर्षी शाहूचे वंचितांच्या उधारातील योगदान	डॉ. व्ही. एस. गोर्डे	३८-४३
८	केळूगण गावचा इतिहास	डॉ. आर. आर. सोनवणे	४४-४८
९	स्वतंत्रपूर्व काळातील कामगार चळवळीची वाटचाल	डॉ. एच. वाय. गायकवाड	४९-५२
१०	सेनापती दाभाडे घराण्याची मराठ्यांच्या इतिहासातील उपेक्षित एक अभ्यास	डॉ. एस. के. भांमरे	५३-५७
११	महात्मा फुले यांची शैक्षणिक कमगिरी	डॉ. आर. एम. कुरुमकर	५८-६२
१२	श्रीगोंद्याचा ऐतिहासिक अभ्यास	डॉ. एम. एम. जगदाळे	६३-७०
१३	भिमथडीच्या शेतकरी बंडाचा ज्ञात अविष्कार	डॉ. डी. ए. मोरे	७१-७३
१४	शेवगाव तालुक्याचा स्थानिक इतिहास	डॉ. एस. एन. मिरे , प्रा. एच. एन. जमाले	७४-८३
१५	महर्षी विठ्ठल रामजी शेतक-यांसाठीचे कार्य व आर्थिक धोरण	डॉ. मीना साळे	८४-८५
१६	कामगार चळवळ आणि नारायण मेघाजी लोखंडे	प्रा. बी. जे. काकडे	८६-८९

कामगार चळवळ आणि नारायण मेघाजी लोखंडे

प्रा. काकडे बी.जे.

इतिहास विभाग

न्यू आर्ट्स कॉमर्स अँड सायन्स कॉलेज,
पारनेर

प्रस्तावना:-

भारतात कामगार चळवळीचा इतिहास-साधारणतः कारखान्यांच्या स्थापनेपासून सुरु झाला आहे. कामगारजीवनातील स्थिती सुधारण्यासाठी पगारदारांनी केलेले सातत्यपूर्ण संघटन म्हणजे ट्रेड युनियन हे डोबळमानाने म्हणता येईल. "स्वदेशी चळवळ" हा कामगार चळवळीच्या इतिहासातील महत्त्वाचा टप्पा समजला जातो. या काळात चिपिनचंद्र पाल, सी.आर.दास यासारख्या नेत्यांनी कामगार संघाना स्थापन करणे, त्या कायदेविषयक सल्ला पुरविणे, संप काळात मदत देणे या कामी पुढाकार घेतला. या काळातील कामगार चळवळीचे दुसरे वैशिष्ट्य म्हणजे आतापर्यंत फक्त आर्थिक कारणांसाठी झगडणारा कामगार यापुढे तत्कास राजा स्वतःच्या प्रश्नासाठीही रस्त्यावर येऊ लागला.

१८७० नंतर कामगारांची स्थिती सुधारण्याच्या हेतूने काही प्रयत्न करण्यात आले परंतु ते परोक्ष वृत्तीने बंगालमधील ब्राम्ह समाजसुधारक यांनी कलकत्ता येथे १८७० साली एक 'कामगार क्लब' स्थापन केला. कामगारांकरिता 'भारत ब्रम्हजीवी' नावाचे मासिक सुरु कले. सोराबजी शापूरजी बॅंगाली यांनी कामगारांचे तास कमी करण्याचा प्रयत्न केला परंतु तो सफल झाला नाही. परंतु त्याचेवळी नारायण मेघाजी लोखंडे यांनी कामगार चळवळीसाठी पुढाकार घेतला आणि कामगारांना न्याय मिळवून देण्याचा प्रयत्न केला. नारायण मेघाजी लोखंडे जीवनचरित्र:-

कामगार चळवळीचे जनक म्हणून नारायण मेघाजी लोखंडे यांना ओळखले जाते. क्ष्यांचा जन्म १८४८ रोजी पुणे जिल्ह्यातील सासवड जवळचे कन्हैरसर येथे फुलमाळी शेतकरी कुटुंबात झाला. शिक्षण त्यांनी रेल्वे खात्यात कारकून काम केले. ते मुंबईला भांडापालाची नोकरी करीत असताना त्यांनी कामगारांची दुरावस्था जवळून पाहिली होती. अत्यंत अल्प पगारात कामगारांना १३-१४ तास काम करावे लागत होते.

कामगार व मजूर:-

वेगवेगळ्या व्यवसायांमध्ये कामगार वर्ग गुंतलेला असतो. त्याचे दोन प्रकार होते. साधारण कामगार व कुशल कामगार कुशल कामगारांचा समावेश समाजाच्या मध्यम वर्गात होत होता. सोने, चांदी, हिरे, मोती, यांचे अतिशय बारीक, कोरीव नक्षीकाम करून दागदागिने व मौल्यवान वस्तु तयार करारे अनेक कुशल कामगार मुगलकाळात विद्यमान होते. इयांच्या कलाकृतीला देशविदेशात प्रचंड मागी होती. याशिवाय हस्तीदंत, चंदन इ.पासून कलापूर्ण वस्तू बनविण्याचा व्यवसाय तेजीत हेता. वस्त्रांवर कलाकुसर करणारे खास कुशल कामगार होते. मुगलकाळात अनेक कुशल कामगार शाही कारखान्यामध्ये काम करीत. साधारणपणे त्यांची स्थिती चांगली होती. स्वतंत्रपणे काम करणा-या कुशला कामगारांचा एक वर्ग होता. मात्र स्वनिर्मित वस्तु सरळ बाजारात न विकता ते व्यापारांन विकत. त्यामुळे त्यांना अपेक्षेप्रमाणे वस्तूची किंमत मिळत नव्हती. साधारण कामगार समाजाचा स्वतःरावर होता. हया वर्गाची स्थिती फारशी चांगली नव्हती.

कामगार स्थिती सुधारण्यासाठी केलेले प्रयत्न:-

पहिल्या महायुद्धाच्या काळात कामगार वर्गात असंतोष वाढण्यास अनेक गोष्टी कारणीभूत झाल्या. युद्धकाळात कारखानदारांनी भरमसाट नफा मिळविला. परंतु कामगारांच्या वेतनात मात्र वाढ झाली नाही. त्यामुळे कामगार वर्ग कर्जबाजारी व मद्यपानाच्या सवयी इ. अनेक गोष्टीमुळे कामगारांचे राहणीमान व त्याची कार्यक्षमता किमान पातळीवर आणण्यास कारणीभूत ठरल्या.

त्यामुळे अशा वेळेस नारायण मेघाजी लोखंडे यांनी महात्मा फुले यांच्या प्रेरणेने कृष्णराव भालेकर यांनी १८७७ साली पुण्यात सुरु केलेल्या 'दिनबंधु' या वृत्तपत्राच्या माध्यमातून त्यांनी कामगारांच्या समस्या जगासमोर मांडण्याचा प्रयत्न केला. परंतु कामगारांना योग्य न्याय मिळवून देण्यासाठी कामगार संघटना आवश्यक होती. परंतु कामगार संघटना नव्हती आणि लोखंडे हे बॉम्बे मिलहॅण्डस असोसिएशनचे अध्यक्ष म्हणून कार्य करीत असले आणि 'दिनबंधु' नावाचे पत्रक चालवित असले तरी ही संस्था कायदेशीर नोंदणी होऊन स्थापन झालेली संस्था नव्हती. यात कामगारांचा सक्रिय भाग नव्हता. १८८५ साली कामगारांनी संप केला त्यामुळे कामगारात राजकीय जागृती होऊ लागली. १९०८ साली टिळकांना सहा वर्षांची शिक्षा झाली.

त्यामुळे मुंबईच्या शेकडो कामगारांनी स्वयंपूर्ताने सहा दिवसांचा संप केला. ही घटना राजकीय जाणीवेची सांगू शकते.

कामगारविषयक कायदे:-

कामगारांची समाधानकारक राहणीमान ही प्राथमिक मागणी होती. त्यामुळे पहिला आयोग १८७० मध्ये नेमण्यात आला. आणि कामगारांचे नेते नारायण मेघाजी लोखंडे यांनी १८८४ मध्ये लॉर्ड रिफॉर्म कारकिर्दीत पहिला फॅक्टरी कायदा पारित करण्यात आला. या कायदयाने काही तरतुदी करण्यात आले त्या खालीलप्रमाणे.

१. ७ वर्षांच्या खालील मुलाला मजूर म्हणून काम करण्यास बंदी घातली.
२. १२ वर्षांखालील बाल-मजुरांची मुरी ठरविण्यात आली. आणि त्यांचे तास कमी करण्यात आले. १८९१ साली सरकारने दुसरा फॅक्टरी अॅक्ट मंजूर केला. यात स्त्रियांविषयी काही कायदे करण्यात आले.
१. स्त्रियांसाठी कामाचा दिवस ११ तासाचा केला.
२. महिला कामगारांना दुपारी मधली सुट्टी दीड तास केली. तसेच इतरही काही कायदे करण्यात आले.
१. कामगारांना महिन्यातून ४ सुट्ट्या द्याव्यात.
२. कारखान्यातील कामकाजाची देखरेख व तपासणी करण्यासाठी निरीक्षणाची नेमणूक करावी.

रविवारच्या सुट्टीमागील प्रमुख कारण:-

ब्रिटीशांच्या काळात दर रविवारी ब्रिटीश अधिकारी चर्चमध्ये जात असत. त्यामुळे त्यांनी रविवार सुट्टीचा दिवस म्हणून जाहीर केला मात्र त्या काळातील कारखान्यात काम करणा-या कामगारांनी याला विरोध केला. यावरून बरेच वादविवाद झाले. यावेळी कामगार नेते नारायण मेघाजी लोखंडे यांनी कामगारांची स्थिती घालतांना रविवार हा आपल्या खंडोबाचा दिवस असतो असे सांगितले आणि सुट्टी पदरात घेतली. त्या काळात सुट्टी हा प्रकारच अस्तित्वात नव्हता. त्यामुळे या एका दिवशीच्या सुट्टीसाठी बराच संघर्ष करावा लागला. जून १८९० पासून रविवारची सुट्टी लागू करण्यात आली. ती आजपर्यंत चालू आहे. नुकतेच या सुट्टीचा

जून २०१४ रोजी १२४ वर्षे पूर्ण झाली. भारतात ही सुट्टी मिळवून देण्याचे श्रेय कामगार नेते नारायण लोखंडे यांना जाते.

कामगारांसाठी संघटनांची निर्मिती:

राष्ट्रीय स्तरावरील संघाना भारतात १९२० साली जन्माला आली. १९२० मध्ये ऑल इंडिया ट्रेड युनियन काँग्रेसचे 'आयटक' हे पहिले अधिवेशन मुंबई येथे भरविण्यात आले. या अधिवेशाचे अध्यक्ष लाला लजपतराय हे होते. यासाठी ८०० च्या वर कामगार प्रतिनिधी उपस्थित होते. तसेच या अधिवेशनासाठी पं. मोतीलाल नेहरू, बॅ. जीना, विठ्ठलभाई पटेल यासारखे नेते उपस्थित होते. त्यामुळे कामगारांच्या हितासाठी नारायण मेघाजी लोखंडे यांनी कामगार संघटनांची निर्मिती केली.

समारोप:-

महाराष्ट्रातील कामगार संघटनेला साम्यवादी पक्षाने जरी विशेष भाग घेतला नसला तरी त्या कामगार वर्गांला संघटित करण्याचे कार्य साम्यवादी पक्षाने केले, समाजातल्या दुबळ्या वर्गांला सहाय्य करून त्यांच्या मनामध्ये साम्यवादी कल्पना रुजवली. आणि या सर्वांमध्ये प्रामुख्याने कामगारांना न्याय मिळवून देण्याचे कार्य नारायण मेघाजी लोखंडे यांनी केले. ब्रिटीश शासनाने त्यांना जे.पी. हा किताब देवून गौरव केला. १८९३ मध्ये झालेल्या हिंदू मुस्लिम दंग्यात शांतता प्रस्थापित करण्यासाठी त्यांनी प्रयत्न केले. त्यासाठी ब्रिटीश सरकारने त्यांना रावबहादूर हा किताब देवून त्यांचा सन्मान केला. परंतु पुढे १८९७ मध्ये मुंबईत परसलेल्या प्लेगच्या साथीने त्यांचा बळी घेतला.

संदर्भ:-

१. भिडे / गायकवाड/ नलवडे; आधुनिक भारत (सामाजिक, आर्थिक व सांस्कृतिक इतिहास); फडके प्रकाशन, कोल्हापूर, पृ.१६०
२. तुकाराम जाधव; महाराष्ट्र वार्षिक-२०१२; प्रकाशक द युनिक अकॅडमी, पुणे ; पृ.८९५
३. नी.सी. दीक्षित; भारताचा इतिहास १५२६-१९४७; पिंपळापुणे प्रकाशक; नागपुरे; जुलै २००५;पृ.१५८.
४. शांता कोठेकर/सुमन वैदव, आधुनिक भारताचा इतिहास १८५७-१९२०; साईनाथ प्रकाशने ; नागपूर ; २१ आक्टो १९९६; पृ. ३७६
५. व.ना.कदम; आधुनिक भारत; फडके प्रकाशन ; कोल्हापूर २००५;पृ. १३२
६. महाराष्ट्र वार्षिके ; उपरोक्त पृ. २९५
७. सुमन वैदव/ शांता कोठेकरे; उपरोक्त;पृ.३७६
८. डॉ. श. गो. कोलारकरे; आधुनिक भारत १७६०-१९५० ; मंगेश प्रकाशने;नागपूर २००४; पृ. ३६२

3. Prachin Newase

ISBN-978-81930154-3-5

ली. सी. यु. डी. सावित्रीबाई फुले पुणे विद्यापीठ, पुणे
 व
 अहमदनगर जिल्हा मराठा विद्या प्रसारक समाजाचे,

न्यू आर्ट्स, कॉमर्स अँड सायन्स कॉलेज, पारनेर
आयोजित

एक दिवसीय राष्ट्रीय चर्चासत्र ५ जानेवारी, २०१८

'आधुनिक महाराष्ट्रातील वंचितांचे इतिहास लेखन'



* आयोजक *

इतिहास विभाग

न्यू आर्ट्स, कॉमर्स अँड सायन्स कॉलेज, पारनेर
 जिल्हा अहमदनगर, ४१४३०२ (महाराष्ट्र)

१७	दुस-या महायुद्धाच्या काळातील सोलापूर शहरातील हातमाग कामगारांच्या चळवळी	प्रा. ए. डी. केत	१०-१७
१८	स्त्रियांचे हक्क व त्यांचे अधिकार डॉ बाबासाहेब आंबेडकर	प्रा. अर्जुन चाटे	१८-१००
१९	वंचितांचे समाजसुधारक महर्षी विठ्ठल रामजी शिंदे	प्रा. हरीश शेंडके	१०१-१०७
२०	उत्खनन स्थळ इनामगाव	प्रा. एस. व्ही. गागरे	१०८-११०
२१	जुन्नर तालुक्यातील महादेव कोळी समाजाचे उठाव	प्रा. शांता गडगे	१११-११३
२२	आदिवासी धर्मातील विधी स्थळ, काळ व भाषा	प्रा. एल. बी. काकडे	११४-११६
२३	भारतातील आदिवासी चळवळीचा अभ्यास	प्रा. प्रकाश गावित	११७-१२०
२४	पुणे नगरपालिकेतील ज्योतीराव फुले यांचे योगदान	कं. ए. भानवसे	१२१-१२६
२५	रानाप्रणीत संवादी इतिहास लेखन प्रवाह	ए. एल. भालसिंग	१२७-१३१
२६	प्राचीन मध्ययुगीन नेवासे	डॉ. वेशाली भालसिंग, प्रा. ए. टी. गंडाळ	१३२-१३८
२७	वंचितांच्या दृष्टिकोनातून घिसाडी जमातीचे चिकित्सक विवेचन	प्रा. के. एस. पवार	१३९-१४४
२८	INTERPRETATIONS OF Indian History: COLONICAL Nationalist AND Post Colonial	प्रा. संदिप शिरसाठ	१४५-१५१
२९	History of Ahmednagar	प्रा. व्ही. एस. पानसरे	१५२-१५४
३०	राष्ट्रवीर: साप्ताहिक एक उपेक्षित ऐतिहासिक विचारधन	प्रा. विशाल रोकडे	१५५-१५८
३१	ब्रिटिश कालीन पेट तालुक्यातील (नाशिक) डांग सेवा मंडळाचा सामाजिक योगदानाचा अभ्यास	प्रा. एस. व्ही. पोतदार	१५९-१६३
३२	आधुनिक महाराष्ट्रातील मानसिक, वंचित इतिहास: एक स्त्री	प्रा. वंदना घोडके	१६४-१६९
३३	इतिहास लेखनातील नववनीन विचार प्रवाह व दृष्टिकोन यांचे चिकित्सक मूल्यमापन	प्रा. प्रा. सचिन कांबळे	१७०-१७३

प्राचीन व मध्ययुगीन नेवासे

डॉ. वैशाली भालसिंग,
गंडाळ आबासाहेब सान्हाजी
सहाय्यक प्राध्यापक,
न्यू आर्ट्स कॉमर्स अँड सायन्स
कॉलेज, पारनेर

मानव आपल्या उत्क्रांतीसाठी झटत असतो. विज्ञानाचे किंवा नैसर्गिक शास्त्राचे शोधात असतं किंवा आपल्या उत्क्रांतीसाठी करत असतो. त्यामध्ये सामाजिक शास्त्रे तरी मग कसे राहतील? त्यांनी देखील आपआपल्या परीने त्यासाठी योगदान दिलेले आहे. सामाजिक शास्त्र इतिहास देखील भागे नाही. इतिहासात देखील नवनवीन संशोधने दिवसेंदिवस होत आहेत. इतिहासात वेगवेगळे प्रवाह येत आहेत, वेगवेगळ्या अंगानी इतिहास अभ्यासाला जात आहे. वेगवेगळ्या पद्धतींनी इतिहासाचे विश्लेषण केले जात आहे.

इतिहासाच्या दृष्टीने विचार केला तर आज अनेक नवीन प्रवाह इतिहास अभ्यासाचे आणि संशोधनाचे आपणास पाहावयास मिळतात. त्यामध्ये स्थानिक इतिहासापासून उत्तर आधुनिक इतिहासाचे कठोरमिमासा आपण पाहू शकतो. विचार आणि विचारातून होणारी कृती आपल्याला दुसरा विचार करण्यास भाग पाडतो. आणि त्यातून परत पुढचा विचार आपल्यापुढे येतो. हा विचार आपणास अभ्यास करण्यास भाग पाडत आहे. आणि अशा विचारातून स्थानिक इतिहास पुढे येताना आपणास दिसत आहे.

स्थानिक इतिहास प्रादेशिक व राष्ट्रीय इतिहासाचा अविभाज्य भाग आहे. स्थानिक इतिहासामुळे प्रादेशिक व राष्ट्रीय इतिहासामध्ये भर पडते. " इतिहास हा अतिशय व्यापक विषय आहे. अभ्यासाच्या सोयीसाठी वेगवेगळ्या प्रकारे त्याची विभागणी केली जाते. उदा. प्राचीन, मध्ययुगीन, आधुनिक अशी काळाच्या निष्कर्षांवर केली जाणारी विभागणी. अशीच स्थलाच्या निकषावर केली जाणारी विभागणी म्हणजे जागतिक इतिहास, राष्ट्रीय इतिहास, प्रादेशिक इतिहास आणि स्थानिक इतिहास हा प्रादेशिक विभागाचाच पोट विभाग आहे." कोणत्याही एका छोट्या गावाची मंदिराची, किल्ल्याची, पेटेची, किंवा व्यक्तीची माहिती गोळा करून त्याचा इतिहास लिहला जातो. तेव्हा तो स्थानिक इतिहास होय. त्याला एका विशिष्ट स्थानापुरते मर्यादित केले जाते फोकस हा विशिष्ट स्थानावरतो असतो. त्यामुळे इतिहास समृद्ध होण्यास मदत होते.

स्थानिक इतिहास हा स्थलाकडून सुक्ष्माकडे जाणारा आहे. एखाद्या विशिष्ट स्थानिक भागात जे राहणारे लोक त्यांच्या परंपरा राहणीमान व मुख्यतः संस्कृती तसेच मानसिकतेचा अभ्यास हा स्थानिक

इतिहासाचा मुख्य गाथा आहे. म्हणूनच स्थानिक व प्रादेशिक इतिहासाच्या पायावर राष्ट्रीय इतिहासाची भौगोलिक मर्यादा लहान आहे. प्रदेश ही संकल्पना सापेक्ष आहे. स्थानिक इतिहासात गावांचा इतिहास समाविष्ट केला जातो. परंतु गावाच्या 'एखाद्या भागाचा, पेटेचा किंवा एखाद्या विद्यापीठाचा इतिहास हा देखील स्थानिक इतिहास म्हणून गणला जाऊ शकतो. एखाद्या स्थानाभोवती किंवा विभागाभोवती केंद्रीत राहून त्या स्थानाचे इतिहास लेखन करणे म्हणजे स्थानिक इतिहास लेखन करणे होय.' २

स्थानिक इतिहास हा प्रत्येक गावाला प्रत्येक परिसराला त्यात त्या गावातील ऐतिहासिक घराणे, समाजाच्या चालीरिती, परंपरा मंदीरे त्या गावाने इतिहासात जे जे म्हणून योगदान दिलेले असेल अशा सर्व घटकांचा समावेश हा स्थानिक इतिहासात होताना दिसतो. अनेक इतिहास संशोधकांनी स्थानिक इतिहासात छोट्या गावाचा इतिहास लिहलेला दिसतो. तसाच अल्पसा प्रयत्न 'नेवासे' गावाविषयी मी करत आहे.

महाराष्ट्र ही संतांची भूमी आहे हा दगड धोंड्यांचा देश आहे. हा एकट व तापटांचा देश आहे असे अनेक उल्लेख आपणास साहित्यात महाराष्ट्राविषयी दिसतात त्यामुळे तेथील लोकांची जीवनपध्ती कष्टक-यांची विद आणि साधी राहणी आपल्या लक्षात आल्यावाचून राहात नाही.

नेवासे हे गाव आधुनिक महाराष्ट्रातील अहमदनगर पासून इशान्येला साधारण ५५ कि.मी. अंतरावर आहे. नेवासा हे आज तालुक्याचे मुख्यालय आहे. त्यावरून नेवासा तालुका हे नाव तालुक्यात दिलेले आपणास दिसून येते. १९° १९' ते १९° ४" उत्तर अक्षांश व ७४° ४८' ते ७५° १९' पूर्व रेखांशावर आज नेवासाचे स्थान आहे. हे गाव प्रवरा नदीच्या (गोदावरी नदीची उपनदी) काठावर वसलेले आहे. अगोदर हे गाव प्रवरेच्या डाव्या तीरावरती होते. परंतु नदीने मार्ग बदलल्यामुळे आज या गावाचे नदीने दोन भाग केलेले आहेत. उजव्या तीरावरील गावास नेवासे खुर्द तर डाव्या तीरावरील गावास नेवासे बुद्रुक असे म्हणतात. नेवासे खुर्द हे आज लोकसंख्येच्या दृष्टीने मोठे आहे. परंतु अंतराच्या दृष्टीने फक्त नदी मध्ये असल्यामुळे फारसा फरक जाणवत नाही. परंतु प्राचीन अवशेष हे जास्त नेवासा बु. येथे पहावयास मिळतात.

नेवासा या गावास तशी मोठी इतिहास परंपरा आहे. प्राचीन (इतिहास पूर्व काळापासून) ते अर्वांचित काळापर्यंत नेवासाचा इतिहास पहावयास मिळतो. काही कागदपत्रांची कमतरता आणि नदीने मार्ग बदलल्यामुळे झालेल्या आलल्या ऐतिहासिक अवशेषांचे खंडन या बाबी मात्र इथे प्रभाव पाडतात. नेवासाच्या इतिहासाचे (प्राचीन व मध्ययुगीन) आपण दोन भागात विश्लेषण करू शकतो.

➤ प्राचीन नेवासे:

प्राचीन वाडःमयात कोरीव संख्वात याचे उल्लेख मिळतात. ते निर्धोनावास, निधवास, निवास अशा पित्त नावांनी आहेत. नेवासे येथे लाडमोड टेकाडात डेकून कॉलेजच्या वतीने स.१९५४ ते १९६० या काळात डॉ. सांकलिया व डॉ. हरावती कर्वे यांनी उल्लेखन केलेले आहे. त्यामध्ये अनेक पुरातनवस्तु सापडलेल्या आहेत. इ.स.पुर्व दुस-या दशकात तेथे वस्ती झाली होती. हे आपणास त्यावरून दिसून येते. ताम्रपाषाण संस्कृतीच्या काळातील हे लोक असून ते जोरवे संस्कृतीचे लोक आहेत. हे लोक तांब्याच्या कु-हाडी छत्र्या व मासे पकडण्याचे गळ वापरत असत. त्याच चरोबर दगडाची घासून गूळगूळीत केलेली नव, आश्रमयुगी साधने देखील आढळून आलेली आहेत. काळ्या रंगाचा नक्षी काढलेली भांडी, कळशा आणि भातीचे तवे येथील लोक वापरत असत. मणी देखील तीथे सापडलेले आहेत. "नेवासा चांसियाच्या(तेथिल रहिवाशांच्या) जीवनात रोमन बनावटीच्या अनेक वस्तु जसे मोठ मोठाले मदय, कुंभ, रोमन, काचेचे भागी अर्घणा कुडे इ. ह्या मिळाल्या आहेत."^{११} या वरून त्यांचा व्यापारी संबध ह्या रोमशी होता असे प्रथम दर्शनी वाटते. "नेवाशाच्या उल्लेखनात महाराष्ट्रातील ताम्रपाषाण संस्कृतीचा प्रस्तुत पुरावा पहिल्या प्रथम हाती घेऊन या लोकांचा नवअश्रमयुगीन लोकांशी निकटचा संबध आला आहे हे उघड झाले."^{१२}

आजच्या नेवासा सा गावास निर्धोनावास, निवास, महालय अशी नावे आढळतात. ही नावे कशी पडली व पुढे त्याचे नेवासा कसे झाले हे वेगवेगळ्या कथेतून समजते. "नेवासा संबंधी शिलालेख सापडणारा पहिला उल्लेख नऊरगाव येथील वादय रामचंद्र देव यांच्या शके १२०० (इ.स.१२७८) च्या शिलालेखात सापडतो."^{१३} त्याच प्रमाणे नेवासाला महालय देखील म्हणत असत. त्याच्या देखील वेगळ्या कथा आहेत.

"महानुभवाच्या स्थापना पोथीत नेवासा चे वर्णन आलेले आहे. नेवासा गाव पूर्वी फार लहान होते. या गावाजवळ 'माळी मोहतर्के' म्हणून दुसरे लहान गाव होते. या दोन्ही गावापसून पाच मैल अंतरावर 'लाडमोड' हे गाव होते."^{१४} (लाडमोड हे वादवांच्या काळात महसूल गोळा करण्याचे ठिकाण म्हणून नमुद आहे.) पुढे या तीन्ही गावांचे मिळून नेवासा नदीच्या प्रवाह बदलामुळे परत त्याचे नेवासा खुद आणि नेवासा बुडक ही दोन गावे तयार झाली. या गावाचा उल्लेख स्कंध पुराणात व माघत कर्तीच्या काळात आपणास मिळतात वाला पौराणिक अख्यान देखील आहेत. "डोमंग्राम हुन निर्धोनावास भागी वाचर मुनी असना डो मंगावाहुन नेवासेला जात. श्री चक्रधर चाचरमुनी भुवकाम क्षणभर करत होते."^{१५} असा उल्लेख लिळा चरित्रात देखील आलेला आहे.

पुराण कथेनुसार कुबेराच्या निधीचा वास तो निधीनिवास असे महात्म्य आहे. तारकासुरास भिडून राहणा-यास सुरक्षीत ठिकाणी देवांनी मागून घेतले तेव्हा गोदावरीच्या जवळ व प्रचरेच्या काटावर नागपति शिफारस विष्णूनी केली. व कुबेर आपले नऊ कोष घेऊन इथे राहीला. अशी अख्ययिका आहे.

नेवासेचे नाव महालय आहे. त्यावरून दिसते त्याच प्रमाणे 'ज्ञानेश्वरीत' (भावार्थदिपीका) मिळणा-या अल्लेखावरून देखील सिध्द होते.

एसी युगी वरि काळी । आणि महाराष्ट्र मंडळी ।

श्रीगोदावरीच्या कुळी । दविणिला ॥

येथे भुवनेक पवित्र । अनादी पंचकोष क्षेत्र ।

जगचे जीवनसूत्र । जेथे श्री मळस ।।

श्रीज्ञानेश्वरी, अध्याय १८ वा ओवी १७८१मध्ये असा उल्लेख देखील आपणांस मिळतो. याला जेव्हा म्हणून स्कंध पुराणानुसार समुद्रमंथनाची अमृत वाटपाची कथा देखील सांगितली जाते. आणि त्यावेळी निघालेल्या १४ रत्नापैकी अमृताचे वाटप नेवासात प्रवारातीरी झाल्याचे सांगितले जाते. त्यावेळेस विष्णूने मोहोनिचे रूप घेतले होते. त्या मोहोनीराजाचे मंदिर हे नेवासात आहे. (नेवासा खुर्द) तर खंडोबांची पत्नी म्हाळसा हिचे माहेर देखील नेवासात आहे. (नेवासा बुद्रुक येथे खंडोबाचे मंदिर आहे. तेव्हा नेवासा खुर्दास मोहोनिराजाचे नेवासे असे नामभिज्ञ देखील आहे. तेव्हा नेवासा खुर्दास मोहोनिराजाचे नेवासे आणि नेवासे बुद्रुकास खंडोबाचे नेवासे नामभिज्ञ देखील आहे. असे एक ना अनेक उल्लेख साहित्यात आणि विशेष करून वैदिकसाहित्य आणि महानुभव साहित्यामध्ये प्राचीन नेवाशाचे आपणास उल्लेख मिळतात. पण राज्य स्थापणे विषयी माहिती हे वादव काळापासून पराव्यादाखल मिळते.

प्राचीन व्यापार बंधितल्यास नाणे घाट जुन्नर, आळे नेवासे मार्ग प्रतिष्ठान (आजचे पेटण) असा व्यापारी मार्ग होता. त्यामुळे प्राचीन काळात देखील व्यापारात नेवासे अग्रसर होते. स्लाडमोड टेकडावरून झालेल्या उत्खननात देखील तशा रोमशी व्यापारात पुसटश्या खुणा आपणास दिसतात हे महत्वाचे आहे. परंतु मध्ययुगात मात्र एक व्यापारी पेट म्हणून नेवासा तितका पुढे आलेला आपणास दिसत नाही.

➤ मध्ययुगीन नेवासे-

इक्ष्णुतेतील काशी म्हणजे निर्धोनिवास नेवासे हे महाराष्ट्रातील यादव राजांचे केंद्र होते. आणि महाराष्ट्रातील खोर संत ज्ञानेश्वर विठ्ठलपंत कुलकर्णी यांनी ज्ञानेश्वरी देखील येथेच सांगितलेली आहे. तिथे निष्ठाण नेवासा येथील रहिवाशी सचिनानंदबाबा कुलकर्णी १८ व्या अध्यायातील शंभटचो ओळी खूप बोलकी आहे.

शके बाराशे बारोत्तरे | वेदिका केली ज्ञानेश्वरे | सचिनानंदबाबा आदरे | लेंखक जहाला | म्हाळसा मोहणीराज मंदिरामुळे हे तिर्थ क्षेत्र विशेष प्रसिद्धीस आले आहे. शिवभारत कर्ता कविद परमानंद हा निर्धोनिवासकार (नेवासकर) होय.

“औरंगजेबाच्या कैदेत असताना छत्रपती संभाजी पुत्र छत्रपती शाहूंचे लग्न औरंगजेबाने लावून दिले. त्या वेळेस त्याने हा भाग शाहूला लग्नात आंदण म्हणून दिला होता. कैदेतून सुटून आल्यावर शाहूने प्रथम आपला अमल या भागावर सुरु केला” अगोदर हा भाग यादवांच्या काळात यादवांच्या अमलाखाली होता व त्यानंतर तो पुन्हा शाहूच्या रूपाने मराठ्यांच्या अमलाखाली आला. मघल्या काळात अगोदर निजामशाहीत हा भाग समाविष्ट होता. परंतु निजामशाही बुडाल्याने नंतर तो भाग मोघलांच्या ताब्यात आला. मोघलांकडून परत मराठ्यांकडे त्याचा प्रवास झाला इ. स. १७२४ नंतर हा प्रांत हैद्राबादच्या निजामाने घेतला उदगीरच्या लढाईच्या वेळी इ. स. १७६० मध्ये पेशव्यांचा अंमल या ठिकाणी आला. पेशव्यांचा सुबेदार नारे बाजी नगरकर याने या भागाची पुनरचना (प्रशासकीय) केली.

शाहू नंतर पेशवे सर्वसत्ताधिपति बनले पेशव्यांच्या काळात इ. स. १७६० ला हा भाग होळकरांकडे आला तो इ.स. १८०० पर्यंत नंतर इ. स. १८०० ला तो ब्रिटीशांनी ताब्यात घेतलेला दिसतो. म्हणजे होळकर सोडून दिर्घकाळ या प्रदेशावर कोणाचेही राज्य मध्ययुगात राहिलेले आपणास दिसून येत नाही.

निजामशाही राज्या जेव्हा शहाजी भोसले काम करत होते. तेव्हा त्यांचा देखील सहवास नेवासाला लाभल्याचे दिसते. त्याच बरोबर मलिक अंबरने आपली प्रतवारी पध्दती (जमिन महसुलाची) देखील येथे राबवलेली आपणास दिसते. मध्ययुगीन नेवासात औरंगजेबाचे देखील वास्तव्य काही काळ झाले होते. नेवासा वू. येथे असणारे नारद मुनींचे मंदीर (जगाच्या पाठीवर इतरत्र कोठेही नारदमुनींचे मंदीर नाही असा समज आहे) त्याने पाडले व त्याच भग्न अवशेषांचे परत दुसरे मंदीर बांधलेले आहे. ते आज ब-यांपैकी स्थितीत आहे पण तेथे कबर आहे. परंतु हिंदूंची घंटा देखील तिथे पहावयास मिळते. दुसरो काही खूप नाही हिंदू व मुसलमान तेथे मनोभावे पूजा करतात जेव्हा अहमदनगर या ठिकाणी औरंगजेब मृत पावला तेव्हा त्याचा मृतदेह औरंगाबादहून येताना नेवासा येथे टेकवला होता. त्या ठिकाणी तकीया म्हणतात तेथे एक पिराचे टाणे

आजही पहाव्यास मिळले. तेथील व्यवस्था पाहण्यासाठी एका मुस्लिम व्यवस्थेला ६ एकर जमिन दिली होती. आज त्याने ती त्याचा मालकीची करून घेतली आहे.

प्रवरा नदीच्या काठावर गणपती, घाघ-या घाट आहेत हे घाट होळकरांनी बांधलेले आहेत. त्याचप्रमाणे घाघ-या घाटावर प्राचीन महादेवाचे मंदीर आहे. त्यात एका वेळेस एकच माणूस जाऊ शकेल अगदी नेवडेशे ते मंदिर आहे. मोहनोराजाचे जे जुने मंदीर होते (त्याला पाकशाळा असे संबोधले जात असत) ते प्रवरा तीरावर होते. ती पाकशाळा पाहून ट्रस्टने तिथे दुसरी इमारत बांधलेली आहे.

नेवासेत अतिशय चांगल्या स्थितीत असलेले सध्याचे मोहनोराजाचे मंदिर हे होळकरांचे सरदार गंगाधर यशवंत चंद्रचूड यांनी बांधलेले आहे. (चंद्रचूडांना नेवासा परिसरातील २२ गावे जहागिरी म्हणून होळकरांनी दिलेली होती) मंदिरासाठी चार हजार कामगार चार ते सहा वर्षे काम करत होते चार ते पाच लक्ष रुपये खर्च झाला. पेशव्यांनी दर साल १५०० रुपये वार्षिक अनुदान दिले होते. ते १८६० पर्यंत मिळत होते. या मंदिराचे पूर्ण काम इ.स. १७७४ साली पूर्ण झाले. इनाम कमिशनने १८६१ ला अनुदान बंद केले ब्रिटीश सरकारने २४८ रुपये अनुदान प्रतिवर्षी देण्यास सुरुवात केली. सध्याचा खर्च देवस्थानाच्या जमिनीतून व इतर मिळकतीतून केला जातो. या मंदिराची उंची ७५ फूट असून, मंदिराची बांधणी दगडी असून कलाकौशल्याने परीपूर्ण आहे. नाशिक येथील मंदिराच्या बांधणी प्रमाणे या मंदिराची बांधणी वाटते.

नेवासामध्ये आणखी ज्ञानेश्वराचे मंदिर देखील आहे, परंतु जुने मंदिर पाडल्यामुळे आज त्या ठिकाणी दुसरे मंदिर बांधलेले आहे. ते मंदिर एका दगडी खांबासाठी आहे. त्या खांबाला टेकून ज्ञानेश्वरांनी ज्ञानेश्वरी सांगितली असे म्हणतात. त्या खांबावर चंद्र आणि सूर्य कोरलेले आहे. त्यास पैशाचा खांब असे नामाभिज्ञ आहे. (पैस) त्याचप्रमाणे नेवासात मध्ययुगीन मशिद हवा देवळाच्या जागेवर देवळे पाडून बांधल्या असे म्हणतात. त्या मशिदीच्या दगडावर जुणे कोरलेले नक्षीकाम देखील तसेच आहे. प्रवरानदीच्या पात्रात आपण फिरल्यास अनेक नक्षीकाम केलेले दगड आपणास आढळून येतात. त्याची माहिती मात्र मिळत नाही.

गंगाधर चंद्रचूड या होळकरांच्या सरदाराचा वाडा नेवासा बुद्रक येथे आहे. व्यापाराच्या दृष्टीकोनातून नानेघाट ते पैठण या मार्गावर नेवासे होते. यात्रा उत्सव हे वेळोवेळी भरत असत. मोहनोराजाची यात्रा भरत असे. त्याचप्रमाणे नेवासा बुद्रक पासून दिड मैल अंतरावर असणा-या बहिरवाड येथे बहिरोबाची (भैरवनाथाची) यात्रा भरत असत. त्या ठिकाणी मोठे आर्थिक व्यवहार होत असत. तात्पुरती बाजारपेठ निर्माण केली जात असत. परंतु मुख्यतः शेंतीवरतीच भर होता आणि आजही जास्त भर हा शेंतीवरतीच अवलंबून दिसतो.

इ. स. १८०० ला नेवासा हा होळकरांकडून ब्रिटीशांकडे गोल आणि त्यानंतर स्वातंत्र्य प्राप्ती पर्यंत त्यावर ब्रिटीशांचेच वर्चस्व राहिले. तेथे जवळ वडाळा येथे मिशनरी स्थापन होऊन त्याचा प्रभाव नेवासावर देखील पडलेला दिसतो. नेवासाने स्वतंत्र चळवळीत देखील आपले भरोब योगदान दिलेले आहे. त्या संबंधीची यादीच आपणास नेवासा तहसिल कचेरीत पहावयास मिळते. आज मुस्लीम व हिंदू त्याच बरोबर ख्रिश्चनांचा देखील वावर नेवासात आपणास दिसून येतो. समाजात असण-या सर्व धर्मांचे उत्सव हे आनंदाने तिथे साजरे होतात.

नेवासाच्या प्राचीन व मध्ययुगीन इतिहासास संशोधनास आजून मोठया प्रमाणात वाव आहे. त्याचप्रमाणे त्यामुळे स्थानिक इतिहासाकडे पाहण्याचा आपला दृष्टिकोन बदलून मोठया प्रमाणात संशोधन होण्यास मदत होते. नेवासाच्या इतिहासामुळे आपणास जेव्हे संस्कृतीपासून मराठयांच्या प्रशासन व्यवस्थेपर्यंतची माहिती मिळते. मंदिरामुळे इतिहास समजण्यास मदत होती. समाजव्यवस्था समजण्यास मदत होती.

स्थानिक इतिहासात नेवासा या गावच्या इतिहासाचे महत्त्व अनन्य साधारण आहे. हे मात्र खरे

तळ टिपा

- १) प्रा. डॉ. लहू गायकवाड व डॉ. श्रीकांत फुलसुंदर, ऐतिहासिक दुर्ग नारायनगड लोक संस्कृती प्रकाशन नारायनगाव, प्रथम आवृत्ती २०१२ पृष्ठ क्र ९
- २) तर्कतिथे लक्ष्मण शास्त्री जोशी (संपादक) मराठी विश्वकोष—खंड ८ वा महाराष्ट्र राज्य सांस्कृतिक मंडळ मुंबई, प्रकाशन- १९७६ पृष्ठ क्र-९४४
- ३) किल्ला पान-९४५
- ४) प्रा. रामनाथ नन्नवरे, 'नेवासा तालुक्यातील मंदिरांचा इतिहास', एम. फिल प्रबंध (अप्रकाशित) पुणे विद्यापीठ पुणे, पृष्ठ क्र-५७
- ५) प्रा. डॉ. चंद्रकांत आभंग, 'भारत इतिहास संशोधक मंडळ' गौमासिक, पेशवे कालिन जत्रा व त्यांचे प्रशासन अंक १ ते ४ वर्ष १९९७-१९९८ पृष्ठ -१६
- ६) ६ ना नेने भारत इतिहास संशोधक मंडळ पुणे त्रैमासिक तेराव्या शतकातील नेवासे (महानुभव वाडःमयाच्या आधारे) अंक दुस-या, वर्ष-१९३८ पृष्ठ -५४
- ७) प्रा. डॉ. चंद्रकांत आभंग, भारत इतिहास संशोधक मंडळ पुणे गौमासिक, पेशवेकालिन जत्रा व त्यांचे प्रशासन", अंक १ ते ४ वर्ष १९९७-९८, पृष्ठ क्र १६

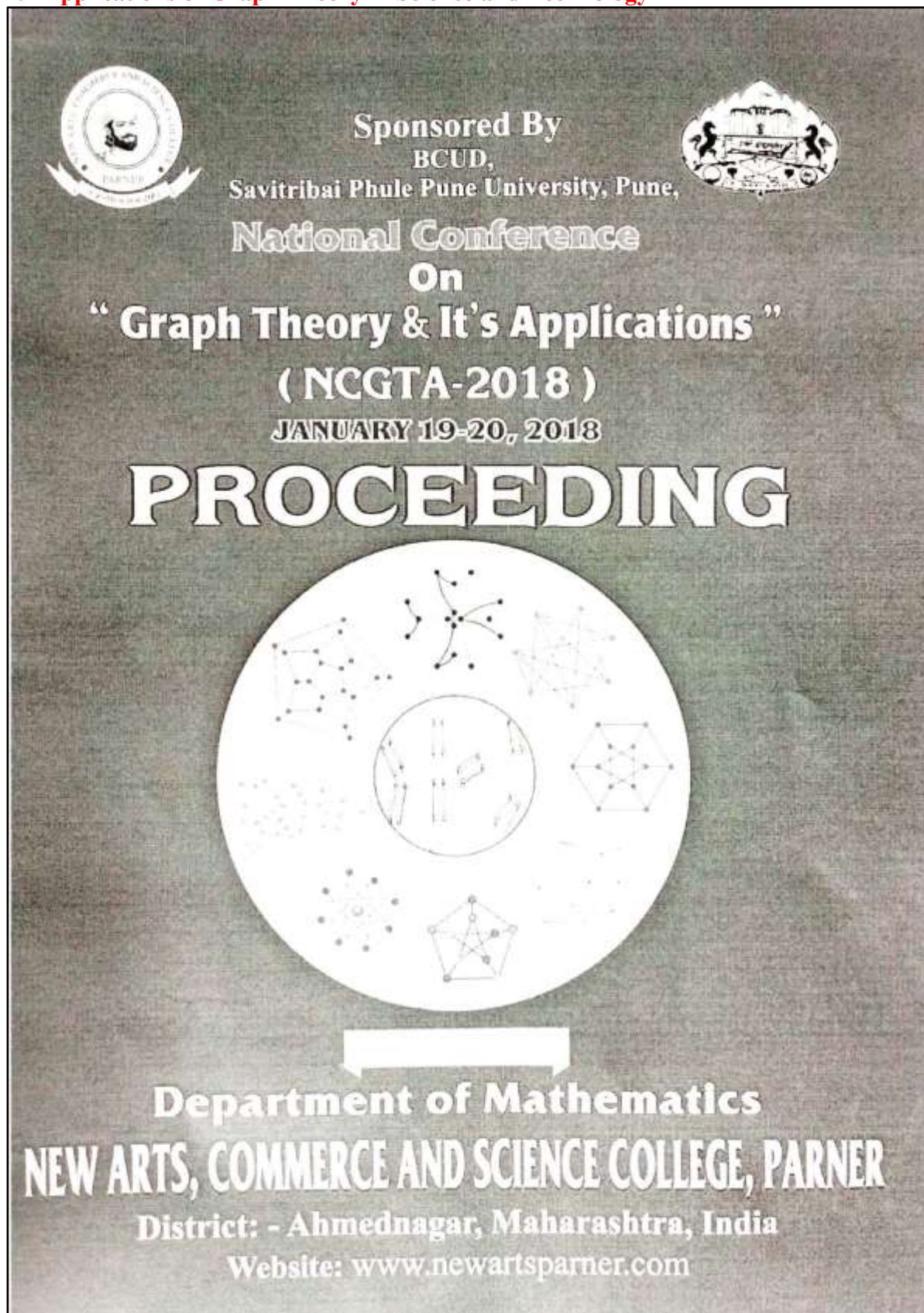
4. Applications of Graph Theory in Science and Technology

Index

Sr. No.	Title of Full Length Paper, Abstract and Author Name/s	Page No.
1.	Solution of Peg Solitaire using Graph Theory Mr. Sandip V. Rawade ¹ & Mr. Vivek S. Mahajan ²	3
2.	Applications of Spectral Graph Theory Mr. Dipak V. Dhokrate ¹ & Mr. Deepak D. Pathave ²	9
3.	Shrikhande graph Mr. Swapnil Kale ¹ & Miss. Mrunali Kapase ²	22
4.	Alternating Trees Mr. Dhernge Mayur P. ¹ & Mr. Vhanmane Suyash P. ²	23
5.	Industrial Application Of Graph Theory Mr. Swapnil Pravin Patil	24
6.	Independent Verification of Euler's Formula in Graph Theory for n-identical circles Mr. Abhijeet D. Yadav	25
7.	Application in Electronic Network Mr. Kohakade Dattatraya. A.	26
8.	Friendly labeling and Zero-edge magic labeling of Corona graph $C_n \circ K_1$. Mrs. Veena Shinde-Deore	29
9.	Extending Business Intelligence with Graph Analytics Mr. Shinde Kiran Hiralal	30
10.	Super weak sum labelling of generalised friendship graphs and fans Mrs. Sheetal Thakare ¹ and Mrs. Manisha Acharya ²	31
11.	Small Graph Matching Mr. Gaikwad Rohan Namdev	32
12.	The Domination In Graph Theory Mr. Saurabh Radhakisan Shinde	33
13.	Applications of Graph Theory In computer Science Miss. Shinde Shubhangi Baban	37
14.	Drawing Power Law Graphs using a Local Decomposition Mr. Rahul Subhash Ingole	40
15.	Applications of Graph Theory in Science And Technology Mr. Gadage V. M. ¹ , Mr. Shinde S. A. ² & Mr. Shinde R. A. ³	41
16.	Application of Graph Theory in the Digital Electronics Mr. B. G.Ghule ¹ , Mr. V. B. Sherkar ^{1*} , Mr. M. S. Parjane ^{2*} & Mr. R. G. Korde ^{3*}	46
17.	Graph Theory and Sustainable Manufacturing Mr. Sudhir R. Wagh ¹ , Mr. Amol U. Lasure ² & Mr. A. P. Wabale ³	50
18.	A Note on Indexing of Subsets Mr. Dnyandeo Namdev Kandekar	51
19.	Applications of Graph Coloring Miss. AbhaleKomal Baban ¹ & Miss. Shelke Archana Babasaheb	52
20.	Graph Theory is a Cornerstone of the Way the Social Network Miss. Prajakta Bhalchandra Chaudhari	53

National conference on
Graph Theory And It's Applications (NCGTA-2018)
New Arts, Commerce And Science College, Parner
INDIA, 19-20, Jan. 2018 ISBN: 978-81-930155-0-9

Applications of Graph Theory in Science And Technology

Mr. Gadage V. M.¹, Mr. Shinde S. A.² & Mr. Shinde R. A.³

Department of Mathematics¹, Department of Computer Science², Department of B.B.A.-C.A.³
N.A.C.S. College, Parner, Dist-Ahmednagar

Savitribal Phule Pune University, Pune

shindeshivajiarun@gmail.com³

Abstract:

Graph theory is a branch of Mathematics which has wide application in other area of Mathematics as well as in other branches of Science and Technology. It has also significant role in our everyday life. In this article we have discussed the application of Graph Theory in our daily life and different branches of science and technology such as Mathematics, Physics, Chemistry, Biology, Computer science, Operation research, Engineering, logistic etc.

Keywords: Graph, Path, Eulerian Graph, Hamiltonian Graph, Tree, Network.

Introduction:

In the first part of this article, we discuss the history and origin of Graph theory and some definitions which are frequently used in studying this subject. The main origin of graph theory was the problem of Konigsberg Bridge. The city Konigsberg was on the both sides of the river Pregl and included two large islands which were connected to each other or to the city by seven bridges. There was a question in the mind of residents of Konigsberg whether they could travel around the city, crossing each of the seven bridges once and only once. In 1736 Leonhard Euler (1707-1783) turned his mind to the problem of Konigsberg Bridge and he came to the conclusion that it did not matter how a man walked around the land or where exactly bridges were, it was not possible to do this. This lead to the concept of Eulerian graph. By solving this problem Euler introduced the new branch of mathematics namely Graph theory. In 1840, A.F. Mobius presented the idea of complete graph and bipartite graph. In 1845, Gustav Kircho introduced the concept of tree and he applied the concept of tree in calculation of currents in electrical circuits. In 1852, Thomas Guthrie found the famous four color problem. In 1856, P. Kirkman and William R. Hamilton studied the cycles of polyhydra and invented the concept of Hamiltonian graph. Although the four color problem was invented it was not solved then. This problem was solved after a century by Kenneth Appel and Wolfgang Haken in 1976. It was the first major theorem to be proved using computer. The term Graph was introduced by Sylvester in 1878. This is how the graph theory was developed.

Preliminaries:

In this section, we have listed some important definitions frequently used in Graph theory.

- **Graph:** A graph G is defined by $(V; E)$ where the elements of the set V are called vertices of graph G and the elements of the set E are called edges of graph G . Here is a function which assigns each edge of the graph G with two vertices.
- **Walk:** A walk on a graph is a finite alternating sequence of vertices and edges, beginning and ending with vertices, such that each edge is incident to its preceding and following vertices.
- **Length of Walk:** Length of a walk is given by the number of edges in the walk.
- **Trail:** A trail is a walk in which all edges are distinct.
- **Path:** A path or simple path is an open walk (walk whose beginning and ending vertices are not same) in which no vertex appears twice or more.
- **Euler Path:** A Euler path is a simple path in a graph which visits every edge of the graph exactly once.
- **Circuit:** A circuit is a path which ends at the same vertex where it begins.
- **Eulerian Graph:** A graph which contains either Euler path or Euler circuit is called Eulerian Graph.
- **Hamiltonian Path:** A path which contains each vertex of graph exactly once is called Hamiltonian path.
- **Hamiltonian Circuit:** A circuit that contains each vertex of graph exactly once except for the first and the last vertex is called Hamiltonian circuit.
- **Hamiltonian Graph:** A graph which contains either Hamiltonian circuit or Hamiltonian path is called Hamiltonian graph.
- **Directed Graph:** A Di-Graph or Directed Graph consists of a vertex set V and an edge set E such that each edge e in E is associated with an ordered pair of vertices. So, if is a function then it assigns every edge to a ordered pair of vertices.
- The difference of directed graph and the graph is in directed graph we use arrow sign in the edges means it has direction.

Applications of Graph Theory

The ideas and concepts of Graph theory are widely used in various branches of science and technology. In general, without knowing the concepts of graph we also use these in our day to day life. For example when we have to go to a place which is connecting with our starting point by deferent ways then we use the shortest road to arrive the destination soon. Here if we observe this problem from the point of view of graph theory the two places can be considered as vertices and roads are as edges. If we also consider the direction of travel, then the graph must be directed. Similarly, we can use these concepts of graph theory in various situations. A graph can be used to present almost any physical situation involving discrete and relationship among them. Here we are now going to discuss the applications of graph theory in various branches of science and technology.

Applications in Computer Science

There is a major role of graph theory in computer science. Graph theory concepts are used to develop the algorithm of different programs. Using these algorithms and programs we can solve different theoretical problems. There are some algorithms listed below:

- (1). Shortest path algorithm in a network.

- (2). Finding minimum spanning tree.
- (3). Finding graph planarity.
- (4). Algorithms to find adjacency matrices.
- (5). Algorithms to find the connectedness.
- (6). Algorithms to find the cycles in a graph etc.

There are many computer languages which help to solve different problems using graph theory concepts. Some computer languages available are

- (1). GTPL - Graph Theoretic Language.
- (2). GASP - Graph Algorithm Software Package.
- (3). HINT - Extension of LISP.
- (4). GRASPE - Another extension of LISP.
- (5). DIP - Directed Graph Processor.
- (6). An interactive Graph Theory System - Extension of FORTRAN.
- (7). GEA - Graphic Extended ALGOL.
- (8). GIRL - Graph Information Retrieval Language.
- (9). FGRAAL - FORTRAN Extended Graph Algorithmic Language.
- (10). AMBIT/G - Extension of AMBIT.

Applications in Operation Research

Graph theory is a very useful tool in operation research. There are some OR problems that can be solved using graphs. In transportation problem, when we need to minimize the transportation cost or maximize the profit, then the graph theoretical approach is very useful. It is also used in different assignment problems such as assigning different people to different jobs, Manage of time table for school, college etc.

Applications in Google map

Now a days, Google map is a very useful tool for travelling anywhere in the world. Using google map we can find all routes from any place to any other place and also can find the shortest route. In case of Google map, we can consider the places as vertices of graph and the routes as the edges. Then the software of Google map, when find the routes between two places it find all edges between these two places or vertices and also gives the shortest edge as the shortest path.

Applications in Internet

Internet is a very useful invention of modern science. In the working technique of internet the

concepts of graph theory are used. In case of connectivity of internet, all the users are considered as vertices and the connection between them are edges. Then all internet users form a very complicated graph and data and information from one user to another user are shared through the shortest route in between them. Similarly, in case of social networking sites one friend is connected to all of his friend and his friends are also connected to others. If we consider the friends as vertices of graph and define an edge in between them if they are friend then it will be a graph.

Applications in Chemistry

Graph theory is used in chemistry for mathematical modeling of chemical phenomena. We can make natural model of a molecule where vertices represent atoms and edges represent bond. There is a branch of mathematical chemistry called Chemical graph theory (CGT) which deals with the non-trivial applications of graph theory to solve molecular problems. The pioneers of the chemical graph theory are Alexander Balaban, Ante Graovac, Ivan Gutman, Haruo Hosoya, Milan Randic and Nenad Trinajstić and others. Graph theory is also used in computational biochemistry.

Applications in Physics

Graph theory is also used in the field of physics. Generally, graph theory concepts are used in different electrical circuits. The current, voltage and resistance on a circuit can be drawn by using graph theory concept. When we want to show the flow of current in circuits then we can use directed graphs. Also we can connect the different physical process with the help of graph theory concepts.

Applications in logistic

The graph theory is a very adequate tool for resolving logistical problems. Let us highlight some of the problems that are resolved through the graph theory and are applicable for modeling of some problems in logistics which are appearing in everyday life: The Chinese postman problem is an example in which we are trying to search for a walk so that we go through every connection in the graph only once and do so in the shortest possible way, using the directed or undirected graph. For better understanding we could imagine a postman who is walking the streets (in our case the graph) and wants to deliver the mail for each house (vertices on the given graph) in the shortest time possible and then return to the post office (starting point). The postman is trying to save time, effort and money by finishing his job using the shortest route. The traveling salesman problem is very similar to the Chinese postman problem at the first sight. It considers the case in which we want search for a walk using directed or undirected graph in the way to cross every vertex of the graph at least once using the shortest possible way. The salesman has to visit all the vertices in the way that he uses the shortest path (the sum of all connections used must be minimal) and return to the starting point. We can imagine that a salesman starts at point a. If the distances between every pair of points are known the question is; what is the shortest route the salesman could take to visit all the other points and return to point a? Search for the minimum spanning tree considers the case in which we want components of unconnected graphs to be connected by using only some given edges. Search for the shortest path comes to use when we want to find the distance or the shortest way between two vertices in weighted graph. Finally we could state that the problems mentioned above show us the problems of the real world very nicely. The solutions of the problems of the graph theory are also very likely to show us the solutions of

National conference on
Graph Theory And It's Applications (NCGTA-2018)
New Arts, Commerce And Science College, Parner
INDIA, 19-20, Jan. 2018 ISBN: 978-81-930155-0-9

logistical problems in everyday life. For examples:

- The paths of the snowplows can be modeled with the help of the graph theory. For this purpose we usually use one of the variations of the Chinese postman problem.
- The construction of cable or electricity network, water supply lines etc. can be resolved with the search of minimum spanning tree.
- The routes and order of transporting goods from warehouses to shops can be modeled with the merchant problem.
- The planning of the phone cable network that is connecting several different objects is modeled with the search of minimum spanning tree.
- Searching for the shortest route is already one of the common problems in everyday life. The popular GPS technology is seen on many motor vehicles as a method of searching for the easiest way to determine the right path to the chosen point on the map.

Conclusion

The main objective of this article is to present the importance of graph theory in different branches of science and our everyday life. Here we have discussed only a few applications of graph theory. There are many application of graph theory in different branches like economics, logistics etc. Therefore graph theory has developed into a subject itself with variety of applications.

References

1. F.Harary, Graph Theory, Narosa Publishing House, (2013).
2. N.Deo, Graph Theory, Prentice Hall of India, Private Ltd, New Delhi, (2007).
3. S.G.Shrinivas, S.Vetrivel and N.M.Elango, Applications of graph theory in computer science an overview, International Journal of Engineering Science and Technology, 2(9)(2010), 4610-4621.
4. NarasinghDeo, Graph theory with applications to engineering and computer science, Prentice Hall of India, (1990).
5. J.A.Bondy, U.S.R.Murty, Graph theory with applications, The Macmillan Press Ltd., (1982).

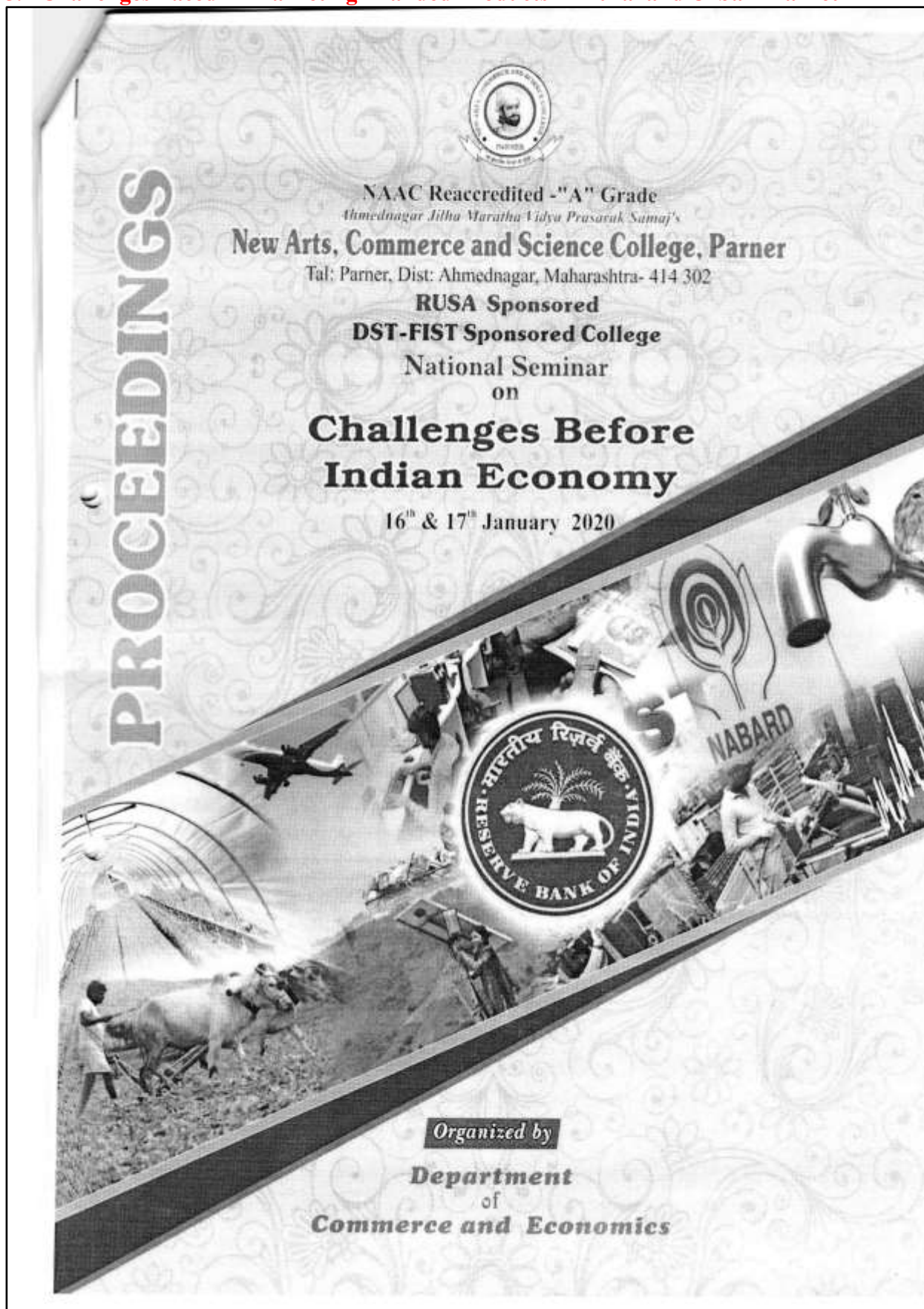
5. Challenges Faced in Marketing Branded Products in Rural and Urban Market

Contents

Sr. No.	Name Of Researchers	Title Of Research Paper	Page No
1.	Agrarian Distress In Indian Agriculture :Emerging Challenges And Policy Implementation	Dr. Bhausaheb .Y. Deshmukh	01
2.	Challenges Before Indian Economy	Prof. Darekar B.P.	10
3.	Problems & Prospects Of Agrobased Industries In Economical Development Of India –A Study	Thorat Rahul Dagadu (Research Scholar) Dr. Mote D.K. (Associate Professor)	14
4.	विक्रम; -"कृषि विकास के लिए विकास के लिए	डॉ. अरुण मिश्र	18
5.	Waiving Farm Loans Is Not Only Bad For The Economy But Also Detrimental To Interests Of The Farmer	Prof. Amita Bhushan Bhalerao	21
6.	Positive And Negative Impact Of GST On The Indian Economy	Asst. Prof. Datir K.R.	24
7.	Impact Of GST On Indian Economy	Mr.Galbote Tushar Ambadas	28
8.	Indian Rural Development : Issues And Challenges	Dr. Govind S Deshmukh	33
9.	Role Of RBI, NABARD In Indian Economy	Prof. Pingat Savita Pandurang	37
10.	Challenges Before Service Sector In India	Dr. Sudhir R. Wagh (Head, Department Of Zoology) Mr. Yuvaraj M. Waghare (Head, Department Of Commerce)	42
11	Impact On GST On Indian Economy	Prof.Mohalkar S.D.	46
12	Emerging Trends In Marketing	Prof. Sushil D. Pawar	49
13	Agriculture Sector In India	Mr. Shivaji Rangnath Pathare	54
14	Impact Of GST On Indian Economy	Prof. Shinde M.D	58
15	Challenges Before Agricultural Sector In India	Dr. Sunita Sadashiv Thube	64
16	Impact Of Inflation On Indian Economy	Prof. Kale Sachin Vijay (M.A.,M.Phil,SET)	71
17	Importance Of Service Sector In India	Dr.B.P.Thakur (M.A.M.Phil.Ph.D)	74
18	Impact Of GST On Indian Economy	Dr.Salve Dharmendra Bhagwan	78

RUSA, DST, FIST sponsored National Seminar on "Challenges before Indian Economy".

By Department of Commerce and Economics, N.A.C.& S. College, Parner, Dist- Ahmednagar (M.S.)

Challenges before Agricultural Sector in India

Dr. Sunita Sadashiv Thube, Department of BBA – CA

New Arts, Com. and Sci. College, Parner

Email id : thube.sunita@gmail.com

Abstract :

For any countries development, agriculture sector has an pivotal role in its process of economic development. In India agricultural industry is still the largest industry serving seventy percent of the population as their livelihood. Agriculture in India is still not at its best. There are many problems faced by it both directly or indirectly regarding the growth and development of agriculture. In the past, technique applied for agriculture was eco-friendly which did not have a yield crop in comparison of today's yield. India over the time, the pattern of cropping has also undergone significant changes. Even today the major portion of the population is still dependent on agriculture for its survival. Farmers were considered to be GOD as they provided food for living. Today it is different and it can be seen that, they have to face many problems and challenges to perform 'agriculture' as their occupation. Techniques of farming have also changed with time and tide.

Keywords : *development, agriculture sector, agricultural industry, population, farmers, food, problems and challenges, techniques*

Introduction :

Farmers and agriculture play a vital role in our life. The technique of yielding crop in the olden days was traditional and eco – friendly but had a low yield in comparison with today's modern techniques. Though the yield was low it meant to be enough as the population was less. Farmers were considered to be GOD as they provided food for living. Today it is different and it can be seen that, they have to face many problems and challenges to perform 'agriculture' as their occupation. Today, agriculture occupation is not respected as before. Farmer does not want his child to be a farmer but wants him to be a businessman or servicemen as majority have low agricultural income. Not many have an urge to adopt agriculture field as their career. Government has respect towards farmers in their states only. But one should not forget that it is because of these farmers that agriculture takes place and that they are the providers of food for our survival.

RUSA, DST, FIST sponsored National Seminar on "Challenges before Indian Economy".

By Department of Commerce and Economics, N.A.C.& S. College, Parner, Dist- Ahmednagar (M.S.)

As farming is not that profitable as expected or required, most of the farmers have opted for jobs other than agriculture and have shifted to other places where industries are situated. Some of them commit suicide because of low or no income from agriculture as unable to survive or unable to pay their loans. Crops fail due to uncertain calamities and disasters. This gives unstableness to the farmers income and are prone to tensions and depressions.

On one side we find farmers committing suicide from depression and on the other hand farmers are enjoying their occupation at large. Farmers are now trying to adopt new techniques for agriculture purpose and are getting more and more profit from farming through optimum yield. Water is bought for agriculture purpose to grow high crop yield. Some of the farmers tend to be eco – friendly where as others are not. For withstanding the increased population importance should be given to improvising crops yield and profit level by implementing new modern techniques of agriculture. These techniques though are modern may reduce the fertility of land and crop quality. Modern techniques are of importance because they help to earn high crop yield and profit for withstanding the population.

It is very much necessary to increase food production to meet the population through increased agricultural land and modern farming techniques. Though it requires increased investments to adopt new farming techniques, it results into high crop yield and profit. The new farming techniques are found by the farmer himself or the researchers. These techniques are eco – friendly or non eco – friendly and are adopted because of its advantages. Though it has advantages non eco – friendly crops can be harmful in the long run as it degrades the soil fertility. So, one should follow the techniques of eco – friendly techniques of agriculture to conserve soil fertility in future. These techniques are made popular through newspapers, journals, digital media etc. This helps to spread at large knowledge of new happenings in agriculture sector. It still as restrictions in spreading its awareness because many of them are computer illiterates or do not have this media/channel of communication facilities in their villages or even cannot afford them. Government should have proper communication network for spreading this information to the last person whether the farmer is educated or not.

Agriculture importance in India :

The development of the economy of any country depends on the growth of agricultural sector, industrial sector and service sector. The lower growth rate of agriculture sector is due to lesser investment which has affected the growth of the economy. The development of agriculture market is vital for the development of our country. Agriculture provides employment to 64% of total population in the country (male and female). According to historical references, agricultural includes animal husbandry, trade, marketing and cottage industries, as the pillars of rural

65 | P a g e

RUSA, DST, FIST sponsored National Seminar on "Challenges before Indian Economy".

By Department of Commerce and Economics, N.A.C.& S. College, Parner, Dist- Ahmednagar (M.S.)

economy. The per capita income in India is very low and its maximum portion is spent on consumption of basic necessities by the population. In India, maximum number of population is engaged in agriculture while in the other countries maximum people depend on agricultural products. Two third of National income was derived from agriculture during the First World War. After planning, the share of agricultural was declined due to development of secondary and tertiary sector of the economy. Since other sectors are not developed as agriculture sector, an employment opportunity for the growing population in this sector is not sufficient and hence unemployment increases, which leads poverty. According to suggestions of Indian experts, for the leading industries like sugar, cotton, jute, tobacco, edible and non-edible oils, dal milling, rice-busking, tur making, oil crushing, handlooms, preservation of fruits and vegetables, agriculture produce have to be increased for its growth.

Characteristics and Problems in Agriculture :

As stated at the outset, Indian economy centres on agriculture. The socioeconomic status of the people, the national polity and the gamut of life of the people is directly controlled by agriculture. The Indian agriculture, however, has its own characteristics. Some of the important characteristics and problems of Indian agriculture have been described briefly in the following section:

1. Poverty of Farmer : The Indian farmer is not very much rich because his main income comes from agriculture as occupation and this agriculture is under developed because of agriculture is dependent of Monsoon, low quality of seeds, small and fragmented land holding, and problems in agricultural marketing. In adequate irrigation facilities, primitive method of cultivation, sufficient supply of agricultural credit and at high rates pressure of population on land and others.

2. Dominancy Traditional Agriculture : In India agriculture is done on traditional basis there are vast areas (almost 70 per cent of the land under cultivation) which are conditioned by the old pattern of water supply, namely, uncertain rains and the use of old agricultural; inputs (like farm-seeds, animal manure etc.) and old agricultural practices (in respect of sowing, harvesting, storage etc.). Only one crop is grown in this area.

3. Rapidly Raising Population : The rapidly raising population as given a problem was it has reduced the size of land under cultivation in regard to were already the land is small sized, which results in efficient farming.

RUSA, DST, FIST sponsored National Seminar on "Challenges before Indian Economy".
By Department of Commerce and Economics, N.A.C.& S. College, Parner, Dist- Ahmednagar (M.S.)

4. Dependent Upon Monsoon : In India the Monsoon is unreliable, irregular and uncertain. Though they are improve irrigation facilities after independence, only one-third of the cropped area is being provided with Perennial irrigation were as the two-third remaining of the cropped area has to be cultivated on dependence on rain water supply

5. Small and Fragmented Land – Holdings : In India the average size of land holdings are less than one hectare and certain part it is even less than 0.5 hectare. The main reason for this is our law of inheritance. According to this law the children get equal distribution in the land belonging to their father. This leads to subdivision and fragmentation of land holdings. This gives rise to irrigation problem fertile and wasted for providing boundaries.

6. Agriculture Marketing : In rural India the marketing system is not properly developed and the farmer for marketing their agricultural produce at a throw – away price. The socio-economic condition force the farmers in small villages to sell their farm produce to the money lenders from whom the usually borrows money. Because of this most of the produced is sold in the village itself. The poor farmers cannot wait for long after harvesting their produce because they are a need of money and so he sells at the given price. The Rural Credit Survey Report rightly remarked that the producer in general sells their produce at an unfavourable place and at an unfavourable time and usually they get unfavourable terms. In the absence of an organized marketing structure, private traders and middlemen dominate the marketing and trading of agricultural produce.

7. An Adequate Transport : In India, most of the villages are not having cheap and efficient means of transportation. Many of the villages are still not properly connected with the market centers or even to the main roads. Most of the roads are 'kutchra' (Bullock – Cart Roads) which may even become not useful in the rainy season, and the farmers are thus unable to carry their farm produced to the main market. This leads to farmers selling their produce in the local markets, and to buy goods for their sustenance goods from the local market.

8. Scarcity of Capital : Like all other industries agriculture is also an important industry which too requires capital. Due to the advanced farm technology capital has gain more money are the commission agents, traders and money lender who charge the farmer a high rate of interest and purchase the farm produce at very low price. It can be seen that still the farmer please an significant role in landing money to the farmers though there is change in the rural credit scenario has grown through a significant change and Institutional agencies like state Co-operative Bank, Cooperative Credit Agencies, Central Co-operative Banks, Some extend loans to the farmers at easy terms.

RUSA, DST, FIST sponsored National Seminar on "Challenges before Indian Economy".

By Department of Commerce and Economics, N.A.C.& S. College, Parner, Dist- Ahmednagar (M.S.)

9. Inadequate Agricultural Research and Education, Training, and Extension:

Though enough progress has been made in the field of agricultural research, there is no coordination between the farm and research laboratories in the different agro-climatic regions of the country. Hence, gains of new agricultural researches are not reaching the common cultivators, especially the marginal and small farmers. Very little attention is being paid for educating and training farmers for the adoption of new agricultural innovations and techniques to increase their agricultural production.

10. Other Characteristics and Problems: There are numerous other problems also which are affecting the agricultural production and rural economy and society adversely. For example, unscientific methods of agriculture, inadequate irrigation facilities, less use of chemical fertilisers, insecticides, pesticides, less remunerative prices of agricultural products, poverty, hunger, and malnutrition of farmers and lack of infrastructural facilities like roads, water, irrigation, electricity, credit, banking, and crop-insurance.

Farming Corporatization would be a Solution:

An idea of corporate farming is that let a corporate own a farming of a village. Let him take the land of farmers on a lease for 5 years or 10 years depending upon his investment. The corporate can give the lease amount either quarterly or monthly to the land owners. Then he can employ the farmers (land owners or not) for his intended crop depending upon his planning. The corporate would provide all the technologies, infrastructures (like cold storages, food processing units etc). Finally the corporate would take back all the crops. If there is more profit, he can distribute bonus among land owners and farm labourers. This would end the problem of investment, technology and other problems which government can't afford. Even FDI can be brought in this sector. This will enhance agriculture productivity, end stress among farmers (land owner or not) and address the farm suicide very effectively. There are some problems also. The above idea can work in the areas having some infrastructures like connectivity, irrigation and other suitability.

India's large farm land lacks connectivity, forget about irrigation. Law and order is also a concern in many areas where corporate wouldn't risk its investment. Sometimes Corporate sector might want a guarantee for collecting his harvest. There would be some problem in labour law related issues. On the other hand as we witness the way Sugar factory cartel harass the sugarcane farmers (not paying the cost of sugarcane and sometimes paying less rate) as in UP and Maharashtra; same thing can develop by cartel of corporates too.

68 | Page

RUSA, DST, FIST sponsored National Seminar on “Challenges before Indian Economy”.

By Department of Commerce and Economics, N.A.C.& S. College, Parner, Dist- Ahmednagar (M.S.)

Precision agriculture (PA) may provide a way to do it:

Precision agriculture may provide a platform for industrial corporate social responsibility (CSR) activity. After all helping the rural poor improve their livelihood through high tech farming should qualify as a CSR activity. The Indian government can facilitate in this process by giving soft loans and sops to the industry so that they get more engaged in agriculture and PA activities. High tech Precision agriculture therefore can help in bringing next green revolution to India and can produce tremendous rural wealth in a sustainable and environmentally sound way. Farmers and farms are the backbone of any country since they can produce food, fuel (agricultural residues) and wealth from the land. They should be helped by all members of society and developing Precision agriculture is a step in the right direction.

Conclusions:

The critical issues that plague Indian agriculture at present are the knowledge deficit and infrastructure deficit, especially in the rural areas. Problems related to irrigation infrastructure, market infrastructure and transport infrastructure add significant cost to farmers' operations. Another issue is lack of delivery mechanisms. There are a number of schemes aimed to bring development in agriculture. We do not have effective delivery mechanisms that can translate into effective facilitation in terms of increasing productivity or decreasing cost or increasing price realization at the ground level. Moreover, inadequate government support exacerbates these issues. Thus, corporate farming could be a solution to Indian agrarian sector, but it needs a deep thinking and innovating better policies so that neither the corporates nor the farmers be at loss. Also the role of central government and state governments needs to be defined clearly as because of being a joint subject, it creates lot of confusion. Eminent experts should do research in this aspect and governments must take a proactive action. Indian agrarian sector in fact requires very innovative ideas for uplifting of this sector. Also, without mechanization, farming is hard and back-breaking work. This has resulted in most farmers' children quitting farming and going for other vocations. Farmers get more money in selling their land to builders, malls and factories. This has put more pressure on farmland, thereby requiring technologies to increase the productivity so that shrinking farmland can feed billion plus people of India in the future. India, though one of the biggest producers of agricultural products, has very low farm productivity, with the average only 33 percent of the best farms world over. This needs to be increased so that farmers can get more remuneration from the same piece of land with few labour.

69 | P a g e

RUSA, DST, FIST sponsored National Seminar on "Challenges before Indian Economy".
By Department of Commerce and Economics, N.A.C.& S. College, Parner, Dist- Ahmednagar (M.S.)

References :

1. <https://www.researchgate.net/publication/330683906>
2. http://14.139.13.47:8080/jspui/bitstream/10603/238840/14/11_chapter%202.pdf
3. <https://www.researchgate.net/publication/227365176>
4. IRJMSH Vol 9 Issue 7 [Year 2018] ISSN 2277 – 9809 (Online) 2348–9359 (Print)
5. <http://www.imedpub.com/journal-food-science-toxicology/>
6. A.N. Agrawal – "Indian Economy" published by New age International Publishers (P) Limited Delhi, 37th Edition, 2011, p – 245.
7. C.B. Mamoria – "Agricultural Problems of India" published by Kitab Mahal, 15, Thornhill Road, Allahabad, Twelfth Edition, 1985, p – 629.
8. State of Indian Agriculture 2012-13 - Government of India, Ministry of Agriculture Department of Agriculture and Cooperation Directorate of Economics and Statistics

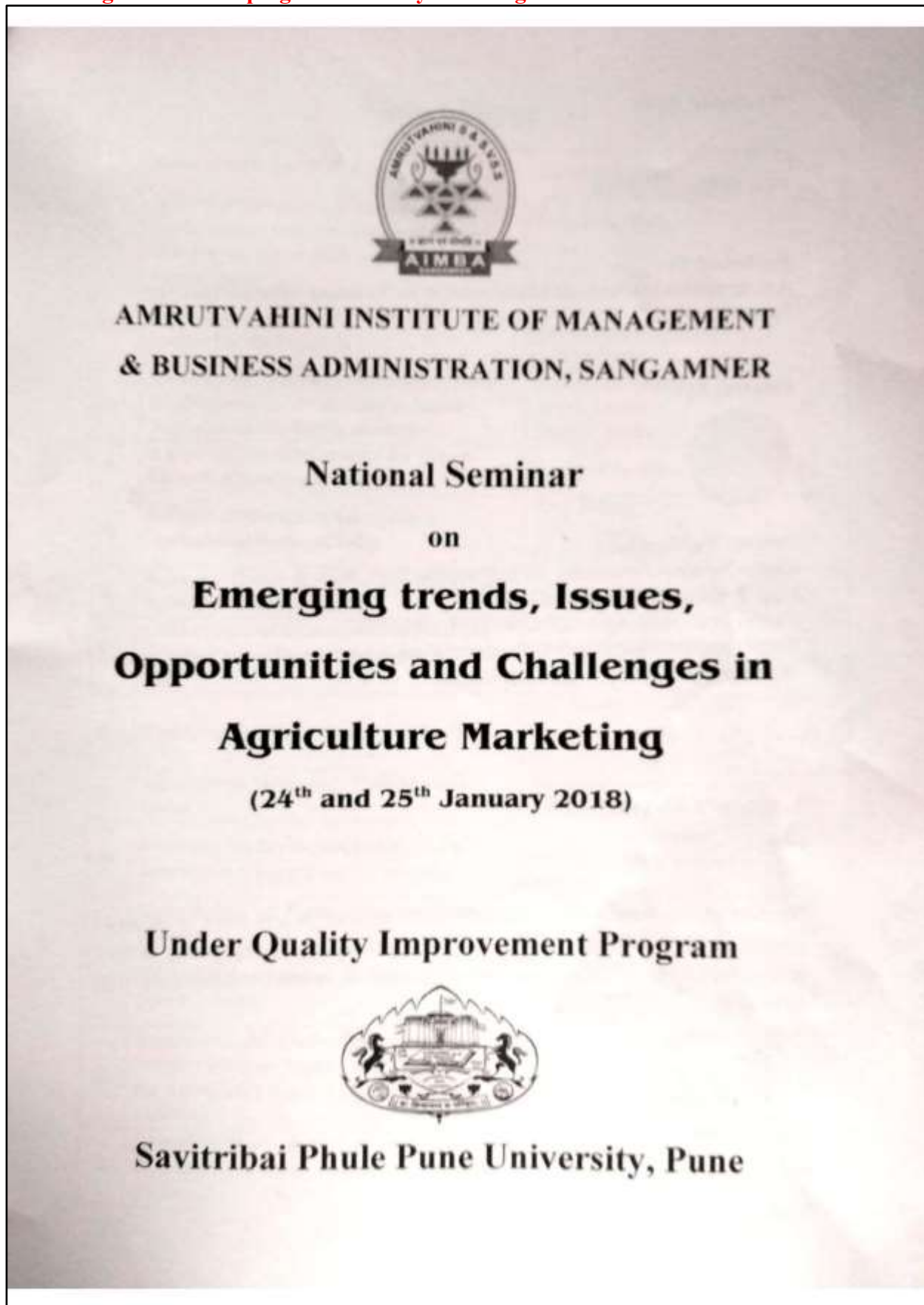
6. Strategies for developing Indian Dairy in Changed Global Scenario

© Editorial Team

First Published: 2018

Published By:
Amrutvahini Institute of Management & Business Administration,
Sangamner

Printing by:



Success Publications

Radha Krishna Apartment, 535, Shaniwar Peth,

Opp. Prabhat Theatre, Pune - 411030.

Contact - 8390848833, 020-24433374, 24434662

Email- marketing@sharpmultinational.com

Website- www.sharpmultinational.com

ISBN: 978-93-87317-96-3

No part of this book may be reproduced or utilized in any form or by any means, electronic or mechanical including photocopying, recording or by any information storage and retrieval system, without permission in writing from author.

List of Paper

Sr. No.	Name of Research Paper	Name of Author	Page No.
1.	Growth performance of agro Based Co-Operative Industries in Implicating Benchmark for Agricultural Marketing in Maharashtra	Mahesh M. Kadam Nilesh Tayade Amit N. Borkar	1
2.	Systematic Analysis of E-Agricultural Alert System for the Farmers	A. Nancy Dr. M. Balamurugan S. Vijaykumar	7
3.	Value Chain Analysis of Ethiopian Coffee (Coffea arabica)- A vital step to inbuilt Agricultural Marketing strategies.	Mahesh M. Kadam, Nilesh Tayade Amit N. Borkar	15
4.	A study of Market Potential for Wheat Flour in Ahmednagar Region	Dr. B. M. Londhe	22
5.	A Study of Marketing Strategies in Agricultural Sector of India	Albashi Baig Tanvi Tiwari Chaitanya Vispute	28
6.	Impact of Goods & Service Tax (GST) on Agriculture Sector in India	Prof. N. M. Nair	34
7.	Contribution of basmati rice from Indian economy specially with Reference to 2014 to 2017	Miss. Monali Waghmare Miss. Neha Pandit	40
8.	Emerging Trends in Agriculture Marketing	Ms. Rashmi Chauhan Ms. Gouri Alhat Ms. kanchan waghmare	49
9.	Agricultural Marketing: Problems and Issues	Mr. Jayraj Javheri Neha Yadav	55
10.	Strategies for developing Indian Dairy Industry in Changed Global scenario	Dr. Ashutosh Gadekar Prof. Ravindra B. Gawali Prof. Mayur P. Gawali	60
11.	Contribution of Fresh Vegetables Export in India	Shweta Ramesh Gunjal Akshada Manoj Kokane	68
12.	NABARD Contribution in Agricultural Sector in India	Miss. Ruchita S. Munot Miss. Pratibha R. Yadav Vedant M Chandak.	74
13.	Espousal Obstructions of M-Government Services towards Bottom of Pyramid (BoP) for Agriculture Related Mobile Applications (ARMA)	Dr. Jaswal A. R. Prof. Nitin S. Bhand	82
14.	Role of Agricultural Informative Resources on Rural Farmers of Ahmednagar District, Maharashtra: A Survey	Changdeo B. Kahandal Uday U. Kulkarni	86

Emerging trends, Issues, Opportunities and Challenges in Agriculture Marketing ISBN : 978-93-87665-27-7

STRATEGIES FOR DEVELOPING INDIAN DAIRY INDUSTRY IN CHANGED GLOBAL SCENARIO

Dr. Ashutosh Gadekar

Associate Professor,
Sinhgad Institute of Management and
Computer Application, Pune
E-mail: gadekarashutosh1@gmail.com
Cell No. 9762061967

Prof. Ravindra B. Gawali

Associate Professor,
Amrutvahini Institute of Management and
Business Administration, Sangamner
E-mail: ravindra_gawali@rediffmail.com
Cell No. 8379027889

Prof. Mayur P. Gawali

Ahmednagar Jilha Maratha Vidya Prasark Samaj's
New Arts Sciences and Commerce College, Parner
E-mail:
Cell No. 9028031521

Abstract

This paper aim at exploring the dairy development strategies in the light of changed global scenario. The authors reviewed reports, newspapers, websites, and working papers to collect authentic data. Dairying has its significance owing to its potential to generate employment and source of income for the majority of the people who live on agriculture for their livelihoods. In developing country like India where poverty, malnutrition, population and unemployment etc are major problems, development of dairy industry plays crucial and critical role in the development of socio economic condition of rural farmers. This paper throw lights on the emerging trends, issues and opportunities in the dairy industry and suggest appropriate dairy development strategies.

Key words: Dairy industry, Dairy development strategies

Introduction

Dairying is a monsoon based industry. It's high turnover low margin industry. Around 2/3rd of Indian population depends upon agriculture. Dairying is becoming their main occupation as its potential to generate regular source of income. It's also used as alternative risk management strategies to crop production which productions and prices are uncertain. India in number 01 in milk production. The credit for the same goes to white revolution and the success of Anand pattern. Dairy industry scenario changed as the Indian dairy industry delicensed in the year 1991 and exposed to private competition as a part of economic reforms. The dairy industry which was earlier dominated by cooperative sector now faces intense competition from the private sector dairy companies which entered into the market with the latest technologies and professional management. Then question arises whether the dairy cooperatives will survive in the changed economic order. Against this background it is important to take the stock of dairy development at domestic and global level.

Global Dairy Scenario

We live in a globally connected world. Economies of the nations are becoming interconnected and interdependent. Events in other countries affect our country. India is

Amrutvahini Institute of Management & Business Administration, Sangamner

60

Emerging trends, Issues, Opportunities and Challenges in Agriculture Marketing ISBN : 978-93-87665-??-?

no exception. It is therefore necessary that world dairy scenario, especially international dairy trade, world production and commodity price needs to be considered.

There has been a global meltdown in the agricultural commodity prices during the year including milk. As per FAO annual food price indices, dairy price index has slumped by 28% in 2015 over 2014, highest among all agricultural commodity prices. The Food Price index has declined by 19%.

Between December 2014 and December 2015, international price of SMP slumped by 20% and now stands at 1800 USD per ton from a high of 2850 USD per ton in March 2015. The comparative price of AMF fell by 10% and now stands at 3485 USD per Ton. When we observe successive GDT auctions, we find that prices have reached a low level equilibrium, lowest compared to past many years. The slump in international prices is essentially due to reduction in imports by few major consuming countries in the world. China, the world's biggest dairy importer, imported 40% less this year as it exhausted stockpiled milk powder and currently facing macroeconomic slowdown. The traditional large importer, Russia, reduced imports by 30%. Reduction in World trade of dairy commodities had a cascading effect on the major exporting countries, leading to reduction in producer prices of milk. Reports indicate that in New Zealand, milk prices paid to their milk producers declined by 40% during past 2 years and in EU milk prices to the producers fell by 25% during the above period. Many countries and Governments are devising innovative ways to handle the crisis.

The record global milk price in 2014 induced farmers to produce more milk and the world milk production increased to 805 million tonnes in 2015, growth rate almost doubling compared to 2013. Milk production in the US continued to rise for the fifth consecutive year. In the EU, removal of past 30 years' quota increased production – particularly in Ireland, the UK and the Netherlands.

Dairy Industry Scenario-India

In India, milk procurement by the cooperatives averaged at 405 LLPD during April-January 2016, up by 14% compared to last year same period. In absolute terms, the cooperatives received 50 LLPD additional milk per day, while they could sell only 10 LLPD. This excess milk supply is coming from dairy farmers who have been abandoned by the private players. Since they find milk collection and conversion into commodities uneconomic in the present market conditions, cooperatives have become the only savior of the milk producers. But dairy cooperatives have constraints like capacity, finite market for liquid milk and involuntary stock build up, but they cannot let down their members, a value system that is ingrained and reinforced in the producer centric organizations.

At a time when the external outlook does not appear promising, it is important that all stakeholders work together to safeguard the interests of domestic milk producers. It has been observed that some players gone in for aggressive cut in milk prices to the producers, while some want to take advantage of low international prices even if it means long term damage to our farmers and to themselves.

There are newspaper reports that farmers in some states where dairy cooperatives and producer owned institutions are weak are the worst hit. Coupled with lower price

Emerging trends, Issues, Opportunities and Challenges in Agriculture Marketing ISBN : 978-93-87665-??-?

for their milk, the valuation of their milch animal asset is also waning now. If this continues, there could be severe adverse consequences.

The dairy industry needs to analyze this situation carefully and come out with strategies to safeguard the interests of our milk producers. **Farmers interests should get top priority and the mantra should be the "Farmers First" and not do anything that affects the economic viability of dairy farming particularly of the small farmers.**

Milk feeding to address hunger and nutrition

The report of Global Hunger Index (2015), released recently, observes that the developing world has made considerable progress in reducing hunger since 2000, where the Global Hunger Index has dropped by 27 percentage points. In India, according to this report, undernourished population stands at 15%, incidence of stunting among the children under 5 years of age is 39% and under-five mortality is estimated at 5%. While the progress is good, we still have a long way to go. The Socio Economic Caste Census (2011) of government of India adopted 7 criteria for deciding on deprivation status of the households and it was found that 10.7 crore households accounting for 60% of all households have some kind of deprivation or other, out of which 30% fall under deprivation criteria of landless households who derive their income from casual labour.

Many of these hungry and under-nourished population live in the rural and backward areas, and milk as a provider of nutrition and dairying as a provider of employment and income have to be recognized as effective development interventions in the context of prosperity of the rural and backward areas.

In almost all the 17 Sustainable Development Goals adopted by the World leaders at the United Nations Special Summit in New York, milk has significant role to play, the most important being nutrition. A diet that contains sufficient milk or dairy to provide 25-33 percent of the daily protein requirement (about 200-250 ml of milk or 15-20 g of milk powder) may have a positive effect on weight gain and linear growth in children aged 6 months to 5 years who are suffering from moderate malnutrition. Every dairy processors and producers should discharge their corporate social responsibilities by gifting milk to the under nourished population.

Dairying to play out under Make in India

In the last 4 decades, India's small holder dairy production system has contributed substantially to the national milk production and to agricultural GDP. From a low base of 22 MMT in 1970, milk production has grown to 146 MMT in 2014-15, with a significant improvement in the per capita availability of milk at 322 grams per day. Increased investment in various sectors and a higher rate of growth will create increasing demand for agricultural produce including milk and dairy products. As stakeholders, we need to broaden our vision to meet the potential demand of quality milk and a variety of milk products. The time is opportune to promote some strong brands by combining our strengths.

Manufacturing of compound cattle feed requires greater attention. As structure of milk production changes in the coming days, there would be greater need to feed our animals with compound cattle feeds, which at present meet only 11% of the

Emerging trends, Issues, Opportunities and Challenges in Agriculture Marketing ISBN : 978-93-87665-??-?

requirements of bovine animals. These need to conform to quality standards and have a region specific focus.

Dairying as a source of livelihood

The All India Debt Investment Survey (NSSO 70th Round) indicates that 44% of the rural households own bovine animals and for about a quarter of the rural households in Tamil Nadu, Kerala (22%), AP (20%), Haryana (15%), Punjab (15%), Rajasthan (11%) and Gujarat (18%) dairying is the chief source of livelihood. The survey also suggests that about 50% of bovine owning households have bank accounts. *With our push for Jan Dhan Yojana, this will move to above 90% in areas with a strong milk procurement structure.*

It is also found another interesting data from our analysis of employment unemployment survey of the NSSO (68th Round). An estimated 15.75 crore rural women in India are engaged in domestic duties out of which 5.29 crore women are willing to undertake additional work. *Out of these, about 1 crore are willing to take up dairy as their preferred work over tailoring, poultry and spinning /weaving. Majority of these women who are inclined to initiate dairying as income generating activity belong to lower income strata and face significant entry barriers.* However, the potential for additional employment generation, especially among women, and incremental milk production are substantial.

It is also revealed that a significant proportion of rural consumers of milk source their milk from "purchases"- numerically rural milk purchasers out number milk producers by 2 times. Some states of Tamil Nadu, Kerala, AP, Maharashtra and West Bengal there are more "rural purchasers of milk" than "rural milk producers". **This has strong implication for exploring opportunities for rural marketing of milk in the organized sector** --something that has been successfully done in Gujarat.

Milk has always played a critical role in addressing hunger and malnutrition. When we turn our attention to what difference does it make when a family is "with" and "without milk production", we observe big differences in milk consumption pattern. Given that other attributes remaining unchanged between milk producing and non- milk producing family, the per capita consumption of milk rises 3 times in the milk producing family. The incremental milk intake is far more relevant in the poor and marginal producer category (per capita intake is higher by 4 times), because otherwise, these families would have gone by without milk, raising nutritional insecurity. *This diversity is not seen in any other items in the consumption basket including cereal, pulses and edible oil.*

In India, structure and composition of agricultural GDP has changed over the years. About three- fourths of the agriculture GDP now is contributed by High Value Agriculture which includes milk and dairy products besides fruit and vegetables, while about 3-4 decades ago, 75% of the agricultural GDP was from cereals. *It is now found that 75% of the food expenditure is towards High Value Agricultural crops including milk and dairy products.*

It is seen that number of cultivator population is reducing in our country even as landless household and agricultural labour population is rising, average land holding

Emerging trends, Issues, Opportunities and Challenges in Agriculture Marketing ISBN : 978-93-87665-??-?

per owner shrinking, urbanization is increasing and structure of agricultural production shifting from cereal to high value crops.

Government initiatives impacting structure of future production

The Government with its renewed focus on urbanization has announced a slew of measures for improving the current urban landscape of the country and building new ones. This is quite evident from the announced big ticket projects of *100 Smart Cities and Housing for all*. These initiatives will create huge employment opportunities in non-farm and non-service sectors, the two sectors that could provide major employment opportunities under skill India initiative. On the flip side, this would also lead to decline in the number of agri-producers, as is evident from the latest census which reported a drop in number of farmers in the country by a staggering 9 million during 2001 and 2011, meaning that there would be lesser hands to produce and more mouths to feed. Increasing productivity of our milch animals through appropriate technology, innovation and their implementation will be the only alternative. NDDDB is implementing National Dairy Plan Phase I (NDP I) which is a scientifically planned multi-state initiative to increase productivity of milch animals and thereby increase milk production to meet the rapidly growing demand for milk through scientific breeding and feeding and to provide rural milk producers with greater access to the organised milk processing sector. Under NDP, NDDDB has strengthened A & B grade semen stations to produce disease free quality semen from the high genetic merit bulls. These are evaluated through scientifically planned program to determine the best bulls & the semen of such bulls is used to produce off springs. The semen doses then produced will be used for AI improving the genetic potential of animals maintained by the farmers.

Ration Balancing Programme (RBP) is being implemented across eighteen states to educate milk producers so that they feed balanced ration to their milch animals for producing milk commensurate with the genetic potential. *About 17000 Local Resource Persons (LRPs) are providing balanced ration advisory services to 10 lakh farmers in 19000 villages for their 13 lakh milch animals using INAPH (Information Network for Animal Productivity and Health) software. Feedback received from a large number of samples indicates a cost advantage of Rs.15-20 per day per animal.*

Unexplored potential of the East

As is true with other sectors, dairying also has not progressed uniformly in all the regions. Eastern Region of the country needs special attention as it seems to be lagging behind in dairying as compared to some of the progressive dairying states such as Punjab, Gujarat and Karnataka. This situation also presents a unique opportunity to us as the Eastern Region seems to be the one which can contribute heavily in accelerating milk production. Fortunately, this can be achieved as the eastern region of the country is better resource endowed in terms of availability of water, fertile soil and man-power. *I envisage that the next Dairy Revolution in India will come from eastern part of our country.*

Emerging trends, Issues, Opportunities and Challenges in Agriculture Marketing ISBN : 978-93-87665-??-?

Lessons for future

Notwithstanding the bottleneck currently faced by the industry I am of the view that we need to prepare our programs with a longer term vision. We have a population of 1.25 billion to feed and meeting their diversified and increasing demand is our national priority. Milk production therefore needs to respond to future needs so that milk is made available at affordable rate and accessible to all.

In our future endeavor of producing more milk, we should not forget that the interests of the farmers should not be undermined. It is in this direction NDDDB through the dairy cooperative institutions and in the social media has been spearheading a campaign of "Farmers First" to educate the consumers about the value provided by dairy cooperatives to farmers. We believe that issues involving the milk producers can only be achieved when the interests of the farmers are safeguarded and they are provided with a sustainable ecosystem to produce milk. *The disturbing trend of over centralization and bureaucratization of state cooperatives coupled with somewhat lax and indifferent governance systems often insensitive to farmers' interests. This needs to change and change immediately.*

Around 85% of rural women are engaged in livestock rearing and agriculture related activities. In villages, it is women who care for, feed and milk the animals. However, in most instances, their contribution never gets highlighted. Raising their participation is essential to the long term strength of dairy cooperative movement. We need to reach-out to them as they can far better carry the message of breeding, feeding and veterinary care.

The need for modernization and expansion of the dairy processing infrastructure cannot be overlooked. The cooperatives are not able to undertake large capital investment for creation of additional capacities and modernizing the plants that were created some 3-4 decades ago. Therefore, investible capital on a soft lending term needs to be made available, which is the urgent need of the cooperatives. This is an area which requires urgent consideration.

The structure of milk production is likely to change. Our milk producers will increasingly adopt new technologies in milk production. Unlike in the past, availability of labour in the rural areas for milk production is becoming an issue. Use of hired labour would require a minimum scale in production. Alternatively, small farmer friendly machines may come in to play. It is our view that characteristics of India's milk production will undergo transformation in a manner that even within the smallholder production systems, improvisation through adoption of modern technology will become prominent.

There are some who argue in favour of duty free imports of milk and milk products to provide cheaper options to consumers. We have to be extremely cautious and sensitive in taking this route since we may end up destroying the economic and social fabric, we have so assiduously nurtured so far. While there is no case for over protection through tariffs and NTBs, a strong case for protecting the livelihood for our farmers exists even today. Let us, in the Dairy sector resolve to act in a manner that supports "Farmers First" in letter and spirit.

Emerging trends, Issues, Opportunities and Challenges in Agriculture Marketing ISBN : 978-93-87665-??-?

Bibliography

- 1] Andrews, N., I. Roberts and S. Hester (1994) "The Uruguay Round Outcomes: Implications for Agricultural and Resource Commodities" in Outlook 94, Proceedings of the National Agricultural and Resource Conference, held in Canberra on February 1-3; also published in World Commodity Markets Trade, Vol. 1, ABARE, Canberra, pp. 171-179.
- 2] Belch, George E., and Belch, Michael A. (1995). Introduction to Advertising and Promotion: An Integrated Marketing Communications Perspective. Boston: Irwin.
- 3] Boyle, Marie A., and Morris, Diane H. (1994). Community Nutrition in Action. St. Paul, MN: West Publishing.
- 4] Chetley, Andrew (1986). The Politics of Baby Foods: Successful Challenges to an International Marketing Strategy. New York: St.Martin's.
- 5] Connor, John M., et al. (1985). The Food Manufacturing Industries: Structure, Strategies, Performance, and Policies. Lexington, KY: D.C. Heath.
- 6] Dandekar, V. M. (1980) "Introduction to the Seminar on Measuring Agricultural Growth" Indian Jl. of Agricultural Economics, 35 (2):1-12.
- 7] Debroy, B., Jha B. and Pailwar V. (1996) India's Agricultural Exports in the Post-Uruguay Setup, a project report submitted to the National Council of Applied Economic Research, New Delhi. *International Journal of Trade, Economics and Finance, Vol. 2, No. 2, April 2011*143
- 8] Elder, John P. (2001). Behavior Change and Public Health in the Developing World. Thousand Oaks, CA: Sage.
- 9] EPM Communications (1998). "TV Is the Most-Often-Used Source of Health Information." Research Alert 16:7.
- 10] Food and Agricultural Organisation (FAO) Production Year Book, various issues.
- 11] Food and Agricultural Organisation (FAO) Trade Year Book, various issues.
- 12] Gandhi, V.P. and G. Mani (1995) "Average Monthly Per capita Consumption Expenditure" Indian Jl. of Agricultural Economics, 50 (3):283-293.
- 13] Goldberg, Jeanne P., and Hellwig, Jennifer P. (1997). "Nutrition Scientists in the Media: The Challenge Facing Scientists." Journal of the American College of Nutrition 16:544-550.
- 14] Goldin I. and D. van der Mensbrughe (1995) "The Uruguay Round: An Assessment of Economy wide and Agricultural Reforms." Paper presented in a World Bank Conference on The Uruguay Round and the Developing Economies, World Bank, Washington D.C.
- 15] Government of India (2002) Basic Animal Husbandry Statistics, published from Department of Animal Husbandry and Dairying, Ministry of Agriculture (GOI).
- 16] Gupta P.R. (1996) Dairy India 1997, an edited book (5th edition) published in A-25, Priyadarshini Vihar, New Delhi-92.
- 17] Hathaway, D.E. and Merlinda D. Ingo (1996) "Agricultural Liberalisation and the Uruguay Round" in Will Martin and L. Alan Winters (edited), The Uruguay Round and the Developing countries, Cambridge University Press, Cambridge.
- 18] Jain, D. K. (1992) Food Demand Analysis in India , an unpublished thesis submitted to National Dairy Research Institute (NDRI), Karnal, India.

Amrutvahini Institute of Management & Business Administration, Sangamner

66

Emerging trends, Issues, Opportunities and Challenges in Agriculture Marketing ISBN : 978-93-87665-??-?

- 19] Jeffrey, D. B.; McLellarn, R. W.; and Fox, D. T. (1982). "The Development of Children's Eating Habits: The Role of Television Commercials." *Health Education Quarterly* 9:174-189.
- 20] Jha, Brajesh (2000) *Indian Agriculture and the Multilateral Trading System*, Bookwell, New Delhi.
- 21] Jha, Brajesh (2002) "India's Tobacco Exports: Recent Trends, Determinants and Implications," *Indian JI. of Agricultural Economics*, 57(1): 53-64.
- 22] Jha, Brajesh (2003) *Indian Dairy in the Emerging Trade Order*, an unpublished report submitted to the Institute of Economic Growth, Delhi -7.
- 23] Jha, Brajesh and B. Debroy (2000) "Towards Globalising Indian Dairy Sector" *Asian Economic Review*, 42(2): 306-319.
- 24] Konandreas, P. (1999) "Next Round of Negotiations in Agriculture with Special Reference to Dairy Sector." *International Symposium on International Prospects for Dairying in the Next WTO Negotiating Round*, held at Buenos Aires, Argentina, June 3-4, 1999.
- 25] Kumar, P. (1998) *Food Demand and Supply Projections for India*, Agricultural Economics Policy Paper 98-01, Indian Agricultural Research Institute, Pusa, New Delhi -12.
- 26] Lalwani, M. (1989) "Technological Change in India's Dairy Farming Sector: Distribution and Decomposition of Output Gains" *Indian JI. Of Agricultural Economics*, 44 (1): 55-66.
- 27] Mathios, Alan D., and Ippolito, Pauline M. (1998). "Food Companies Spread Nutrition Information through Advertising and Labels." *Food Review* 21(2):38-44.
- 28] Munshi K.D. and Kirit S. Parikh (1994) "Milk Supply Behavior in India: Data Integration, Estimation and Implications for Dairy Development" *Jl. of Development Economics*, 45(2): 201-223.
- 29] Nestle, Marion. (2000). "Soft Drink 'Pouring Rights': Marketing Empty Calories to Children." *Public Health Reports* 115:308-319.
- 30] OECD (2001) "OECD PSE/CSE Database 2001" Organisation for Economic Cooperation and Development (OECD), Paris.
- 31] Radhakrishna R. and C. Ravi (1990) *Food Demand Projections for India*, Centre for Economic and Social Studies (CESS), Hyderabad, India.
- 32] Ramesh Chand (1999) *Liberalisation of Agricultural Trade and Net Social Welfare: A Study of Selected Crops*, *Economic and Political Weekly* Vol. 34 (52): A153-159.
- 33] Ratnam C. (1985) "Short Run Supply Functions of Milk: A Note" *Indian JI. of Agricultural Economics*, 40(3): 517-519.
- 34] Shankar Ravi (2003) "Policy and Regulations – Influencing Milk Producers" *Indian Dairyman*, 55(3): 96-100.
- 35] World Bank (1998) "India: The Dairy Revolution (The impact of Dairy Development in India and the World Bank's Contributions)", by Candler Wilfred and Nalini Kumar, World Bank Operations Evaluation Department, The World Bank, Washington, D.C.

Amrutvahini Institute of Management & Business Administration, Sangamner

67

7. Application of Graph theory in the digital electronics

National conference on
Graph Theory And It's Applications (NCGTA-2018)
 New Arts, Commerce And Science College, Parner
 INDIA, 19-20, Jan. 2018 ISBN: 978-81-930155-0-9

Application of Graph Theory in the Digital Electronics

Mr. B. G. Ghule*, Mr. V. B. Sherkar^{1*}, Mr. M. S. Parjane^{2*} & Mr. R. G. Korde^{3*}

Asst.Prof. Department of Physics
 New Arts, Commerce and Science College, Parner, Dist. – Ahmednagar
 SavitribaiPhule, Pune University, Pune (INDIA)
babajighule1992@gmail.com

Abstract:

This paper is showing the application of directed graph to design the digital electronic circuits for various applications and how to avoid the trial and error method to obtain the specified output condition in electronic circuits.

Keywords: Directed graph, Adjacency matrix, Digital electronics, Counter, Truth table.

Introduction:

Graph represents a pair-wise relationship between a set of objects.
 The components of graphs are

1. Vertex (nodes)
2. Edges (arc)



Fig.a**Fig.b**

V_1 and V_2 are the vertex and line joining the vertex is called edge of graph.

Graphs are also of two types,

1. Directed graph (di graph): It's have a pair of ordered vertices (u,v) as in fig. b
2. Undirected graph: It's have a pair of unordered vertices (u, v) and (v,u) are same as in fig. a

For designing the digital electronic circuits directed graphs are useful. The graph data structure is represented in two ways,

1. Adjacency matrix: Represents a graph with v nodes into a $v \times v$, 0-1 matrix. Where $A_{ij}=1$ means vertex i and j are connected.
2. Adjacency list.

Considering following examples of undirected and directed graph let's build the adjacency matrix.

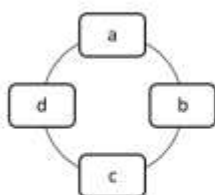

Undirected Graph

	a	b	c	d
a	0	1	0	1
b	1	0	1	0
c	0	1	0	1
d	1	0	1	0

Adjacency Matrix

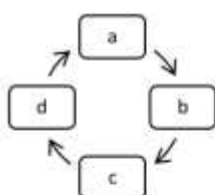

Directed Graph

	a	b	c	d
a	0	1	0	0
b	0	0	1	0
c	0	0	0	1
d	1	0	0	0

Adjacency Matrix

Present Work:

Designing of modulo -5 ripple counter using a 3 bit ripple counter. For above problem we can design the output state diagram as follows,

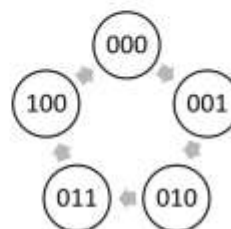
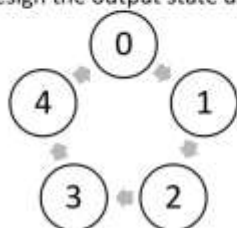

From above graph we get the idea that after state 4 i.e. 100 the counter should reset to 0 i.e. 000. Then we can construct the truth table for counter as below,

State	Q _c	Q _b	Q _a	Q _c ' for next step
0	0	0	0	1
1	0	0	1	1
2	0	1	0	1
3	0	1	1	1
4	1	0	0	1
5	1	0	1	0
6	1	1	0	0
7	1	1	1	0

To build the circuit for above truth table we can construct the k-map,

$Q_B Q_A$	00	01	11	10
Q_C	0	1	1	1
	1	1	0	0

Expression for Y is

$$Y = \bar{Q}_C + \bar{Q}_B \bar{Q}_A$$

The states 0 through 4 are valid states and the output Y of reset logic (Y) is inactive (1) for them. The state 5, 6 and 7 are invalid state. If counter enters into any one of these state that Y=0 (active) and will reset all the flip-flop. And the graph data structure is represented by adjacency matrix as,

	0	1	2	3	4
0	0	1	0	0	0
1	0	0	1	0	0
2	0	0	0	1	0
3	0	0	0	0	1
4	0	0	0	0	0

The circuit is then constructed as,

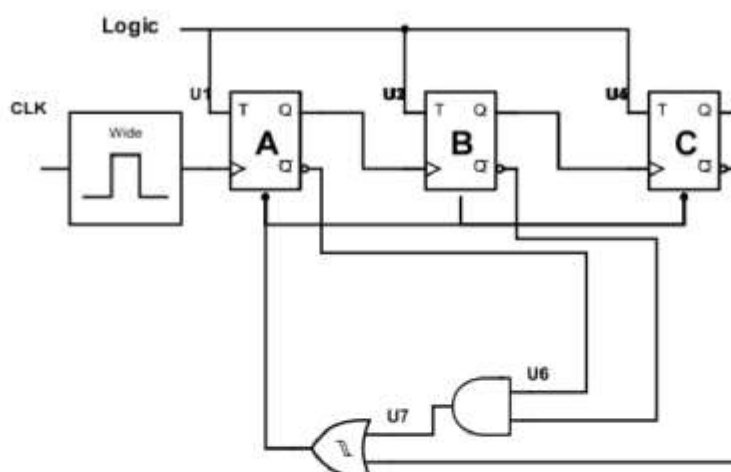

Conclusion:

Graph theory is a very interesting topic in mathematics due to numerous applications in various fields especially in computer and electrical engineering. We use the graph theory concept and techniques that we have developed to study digital electronics. Thus, graph theory has more practical application particulars in solving electric network.

A circuit network can be represented by different method which include

- Circuit representation
- Graph model representation
- Matrix method by using logical truth table

References :

1. A. Sudhakaran, Electrical circuit analysis, Tata Mc Grow-Hill Pvt Ltd.
2. B. Bollobas, Modern Graph Theory, Springer 1998.
3. F. Kirchoff's, Ubar die Auflosung der Gleichungen, aufwelche man bei der Untersuchung der linearen Verteilung galvanischer Stromefuehrt wird, Ann. Phys. chem. 72(1847), 497-508
4. Introductory Graph Theory for Electrical and Electronics Engineers, IEEE MULTIDISCIPLINARY ENGINEERING EDUCATION MAGAZINE.

8. Nanotechnology for energy applications

International Conference on Nanotechnology for Human Welfare 2018

ISBN : 978-93-87317-98-7

Nanotechnology for Energy Applications

Kadam S. L.

Department of Physics, New Arts, Commerce and Science College, Parner,
Dist. Ahmednagar, MS, India-414302.

Presenting author: mr.sukadeo@rediffmail.com

Abstract

Nanotechnology is an interdisciplinary science. It needs Physics, Chemistry, Engineering, Biology etc so that its full potential can be exploited for the advantage of mankind. It plays an important role in the field of energy. Natural energy resources coal, oil, natural gas used in all transportation, communication, agriculture, industry, houses and many other human activities are limited depleting very fast. The future generation will have to look alternative sustainable energy sources like nuclear, geothermal, wind, solar energy or hydrogen based fuel cells to satisfy their requirements. As the energy demands are increasing day by day, nanotechnology is developed. It gives more effective and efficient process to produce more energy. Nanoscience studies the phenomena and the manipulation of materials at atomic, molecular and macro-molecular scale which the physical properties such as electrical conductivity, magnetic properties, fluorescence, hardness or strength are very different compared to the material on a large scale. Nowadays, nano-scale materials made from carbon, composites, metals and alloys, polymers, glass and ceramics have already been available in the market. The examples of nanotechnology development in the energy sector include conventional energy sources (fossil and nuclear) and renewable energy sources (geothermal, solar, wind, hydro and biomass). The development of nanotechnology can be the key to solving the future energy problem. Current applications of nanotechnologies in the energy sector, such as lithium-ion batteries, fuel cells, light emitting diode (LED), ultra-capacitor and solar cell (including Gratzel cell) can improve the efficiency and utilization period. The problems that arise while improving the performance of Li-ion batteries are that there is no electrode material that can satisfy all required performance characteristics, such as high capacity, high operating voltage, and a long life cycle. To overcome this problem many researchers tried to optimize the electrode materials by designing composite structures at nano level. By reducing the size of the material used in battery, higher conductivity can be achieved so that the power of the battery will also increase. With nanotechnology, it is possible to have materials with different molecular structures in a single solar cell, resulting in absorption of photons in much wide wavelengths. Because of much smaller particle size, the area available for absorption of energy is also considerably higher. Efficiency can improve up to 50%. Capacitors are another form of energy storage. Because of the huge surface area requirements, the use of capacitors has limited to low energy applications. Because of the very small size of nanoparticles, it is possible to produce highly porous electrodes, which tremendously increase the surface area, leading to production of ultra-capacitors that can have much higher charging and discharging rates at higher voltage levels. Nanotechnology will help in producing much higher electric power. It will be possible to convert our daily movements to electricity that our mobile devices can power.

REFERENCES:

1. Sulbha K. Kulkarni, Nanotechnology: Principles and Practices
2. E. Christian, Edith, Selly, D. Adityawarman, A Indarto, Front. Energy -2013, 7(1), 6-18.

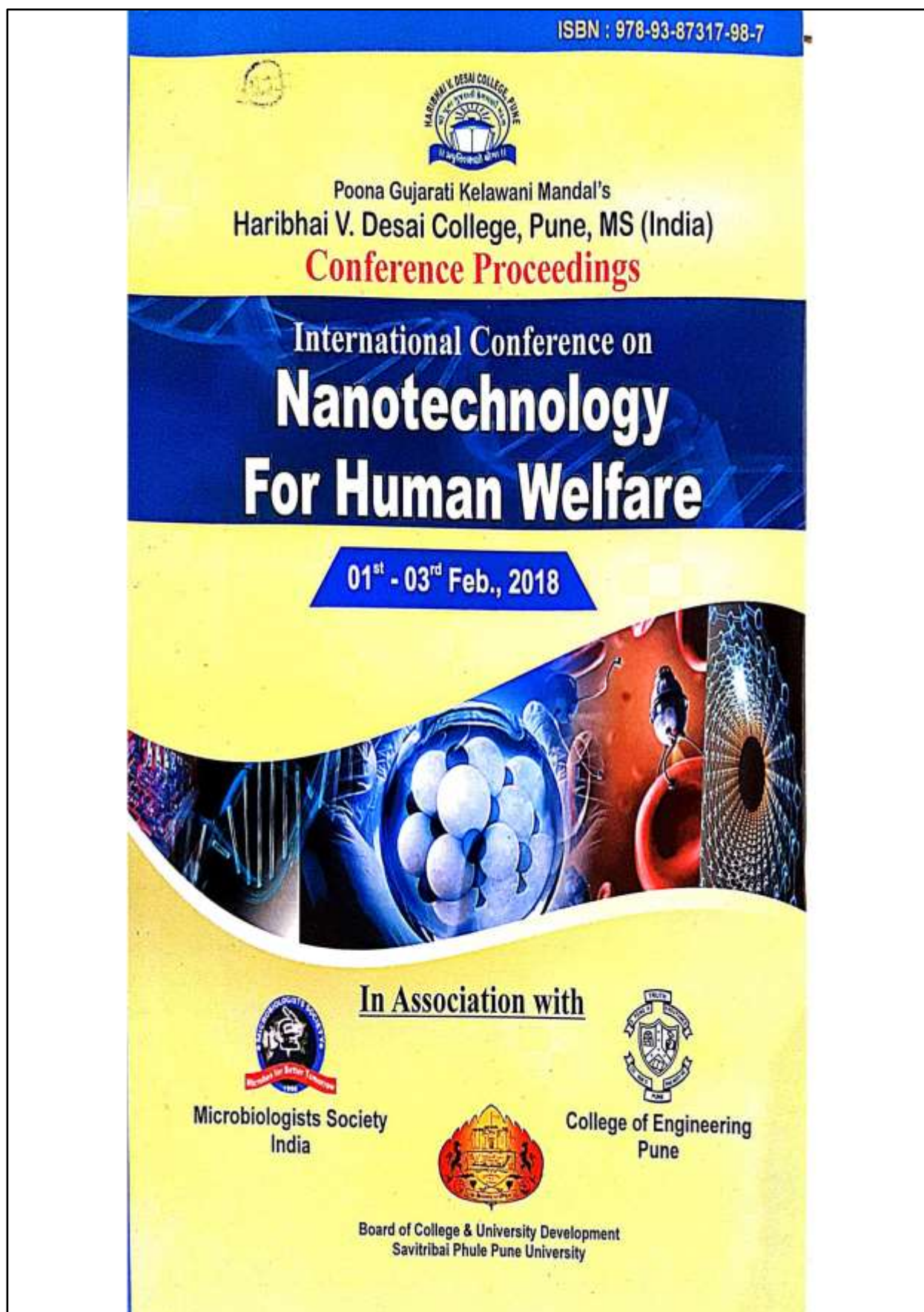

9. Solar energy and environment

6th International Conference on Recent Trends In Life Sciences (ICRTLS 2017)
29-30 December, 2017

SOLAR ENERGY AND ENVIRONMENT

S. L. KADAM

Post Graduate Department of Physics, New Arts, Commerce and Science College,
Parner, Dist. Ahmednagar, MS-414302, India.
Email- mr.sukadeo@rediffmail.com

ABSTRACT

Renewable energy plays an important role in reducing greenhouse gas emission. It is becoming an alternate energy source to conventional energy. It is increasing energy security by diversifying its energy mix and reducing import dependence on fossil fuels. There are five commonly used renewable energy sources. 1. Biomass- It includes wood and wood waste, municipal solid waste, landfill gas and biogas, ethanol and biodiesel. 2. Hydropower 3. Geothermal 4. Wind 5. Solar. In all these energy sources, worldwide the importance of solar energy is recognized. Solar power has strongest positive perception compared to other. Solar energy does not produce air or water pollution or greenhouse gases. Solar energy can have a positive, indirect effect on the environment. However, some toxic materials and chemicals are used to make the photovoltaic cells that convert sunlight into electricity. Many countries have a great potential to generate electricity from solar energy. Some solar thermal systems use potentially hazardous fluids to transfer heat. Leaks of these materials could be harmful to the environment. Some countries environmental laws regulate the use and disposal of these types of materials. Similar to other power plants, large solar power plants can affect the environment near their locations. Clearing land for construction and the placement of the power plant may have long-term effects on habitat areas for native plants and animals. Some solar power plants may require water for cleaning solar collectors and concentrators or for cooling turbine generators. Using large volumes of ground water or surface water in some arid locations may affect the ecosystems that depend on these water resources.

Keywords: *Renewable Energy, Solar energy, Environment.*

EFFECTS OF SHORT-TERM MAGNETIC FIELD EXPOSURE ON GERMINATION, GROWTH ON SEEDS OF PEA (*PISUM SATIVUM*), CHICK-PEA (*CICER ARIETINUM*).

ASHUTOSH KHADE AND AVINASH MANCHARKAR

Department of Physics,
New Arts, Commerce & Science College, Parner, 414302, India

ABSTRACT

The Numerous studies have been carried out to investigate the effect of short-term magnetic field exposure on plants, where seedlings (4–5 days old) were continuously exposed and grown under short exposure condition. Here, we have used a novel 'short-term magnetic field exposure experimental method' where imbibed seedlings were exposed to higher gauss values ranging from 300 gauss to 0.2 Tesla for a short interval time of 10 minutes. Changing patterns in peas and chick-peas germination and growth, along with various photosynthetic and biochemical parameters were studied. Results revealed the significant inhibition of germination and growth in short-term magnetic field exposure treated seeds over control. Photosynthesis parameters such as chlorophyll content were found to be affected significantly

*Department of Botany and Research Centre, NACS College, Parner,
Dist- Ahmednagar (M.S.) India, 414302*

95

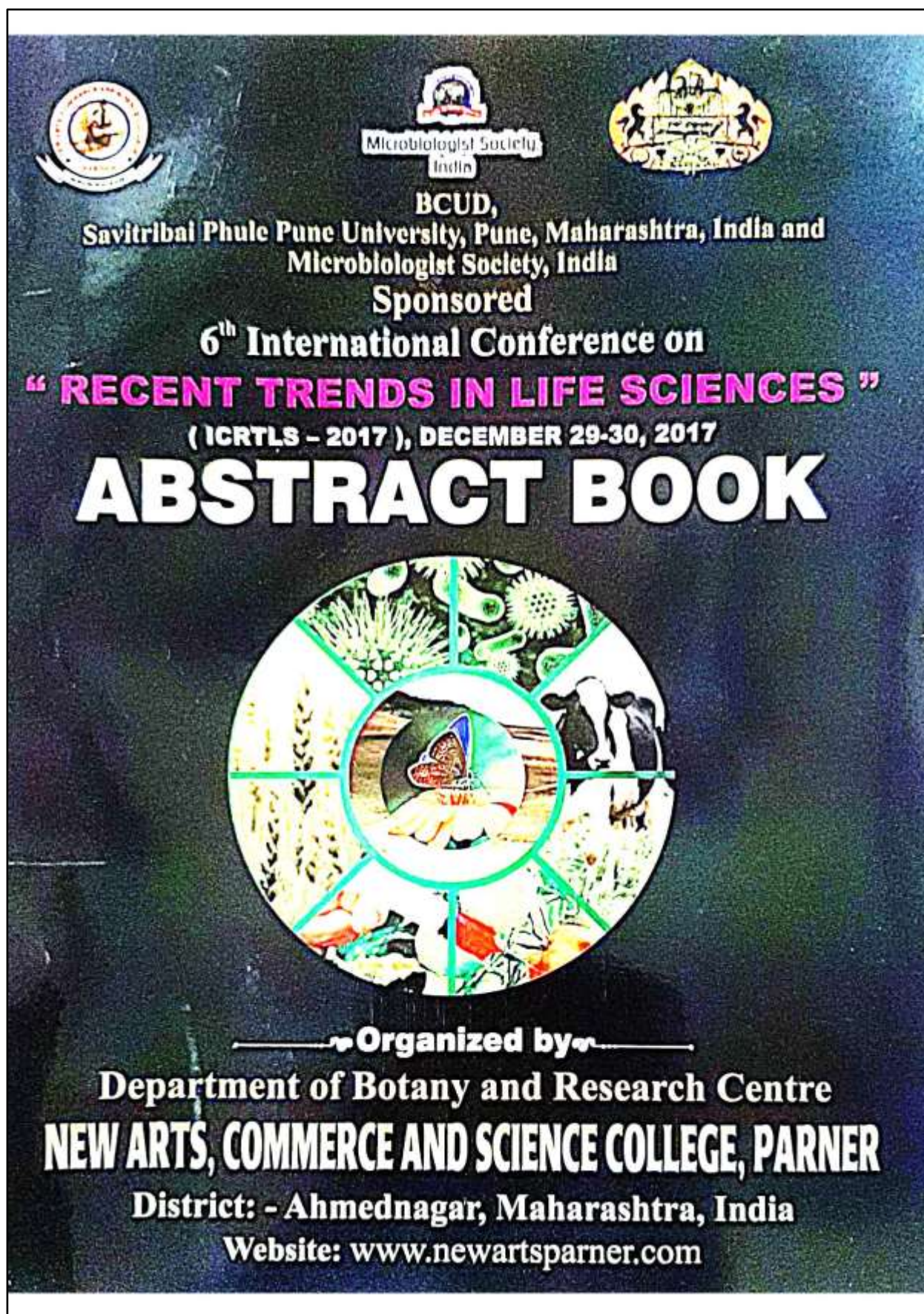

10. Interdisciplinary Application of Mathematics

National conference on
Graph Theory And It's Applications (NCGTA-2018)
New Arts, Commerce And Science College, Parner
INDIA, 19-20, Jan. 2018 ISBN: 978-81-930155-0-9

Interdisciplinary Approach of Graph Theory

Mrs. Rani Dadabhau Sonawane
Asst.Prof. Department of Mathematics
N. A. C. S. College, Parner, Dist-Ahmednagar-414302
rdsyr13@gmail.com

Abstract :

In general, graphs theory has a wide range of applications in diverse field's. Computer Science and Engineering fields have many situations where a knowledge of graph theory is needed. This paper aims to emphasize the applications of graph theory in daily life and technologies Computer science, Operation Research, Chemistry, etc.

11. Applications of Graph Theory in Science & Technology

National conference on
Graph Theory And It's Applications (NCGTA-2018)
New Arts, Commerce And Science College, Parner
INDIA, 19-20, Jan. 2018 ISBN: 978-81-930155-0-9

Applications of Graph Theory in Science And Technology

Mr. Gadage V. M.¹, Mr. Shinde S. A.²&Mr. Shinde R. A.³

Department of Mathematics¹, Department of Computer Science², Department of B.B.A.-C.A.³
N.A.C.S. College, Parner, Dist-Ahmednagar

Savitribal Phule Pune University, Pune

shindeshivajianun@gmail.com

Abstract:

Graph theory is a branch of Mathematics which has wide application in other area of Mathematics as well as in other branches of Science and Technology. It has also significant role in our everyday life. In this article we have discussed the application of Graph Theory in our daily life and different branches of science and technology such as Mathematics, Physics, Chemistry, Biology, Computer science, Operation research, Engineering ,logistic etc.

Keywords:Graph, Path, Eulerian Graph, Hamiltonian Graph ,Tree,Network.

Introduction:

In the first part of this article, we discuss the history and origin of Graph theory and some definitions which are frequently used in studying this subject. The main origin of graph theory was the problem of Konigsberg Bridge. The city Konigsberg was on the both sides of the river Pregl and included two large islands which were connected to each other or to the city by seven bridges. There was a question in the mind of residents of Konigsberg whether they could travel around the city, crossing each of the seven bridges once and only once. In 1736 Leonhard Euler (1707-1783) turned his mind to the problem of Konigsberg Bridge and he came to the conclusion that it did not matter how a man walked around the land or where exactly bridges were, it was not possible to do this. This lead to the concept of Eulerian graph. By solving this problem Euler introduced the new branch of mathematics namely Graph theory. In 1840, A.F. Mobius presented the idea of complete graph and bipartite graph. In 1845, Gustav Kircho introduced the concept of tree and he applied the concept of tree in calculation of currents in electrical circuits. In 1852, Thomas Gutherie found the famous four color problem. In 1856, P. Kirkman and William R. Hamilton studied the cycles of polyhydra and invented the concept of Hamiltonian graph. Although the four color problem was invented it was not solved then. This problem was solved after a century by Kenneth Appel and Wolfgang Haken in 1976. It was the first major theorem to be proved using computer. The term Graph was introduced by Sylvester in 1878. This is how the graph theory was developed.

Preliminaries:

In this section, we have listed some important definitions frequently used in Graph theory.

- **Graph:** A graph G is defined by $(V; E)$ where the elements of the set V are called vertices of graph G and the elements of the set E are called edges of graph G . Here is a function which assigns each edge of the graph G with two vertices.
- **Walk:** A walk on a graph is a finite alternating sequence of vertices and edges, beginning and ending with vertices, such that each edge is incident to its preceding and following vertices.
- **Length of Walk:** Length of a walk is given by the number of edges in the walk.
- **Trail:** A trail is a walk in which all edges are distinct.
- **Path:** A path or simple path is an open walk (walk whose beginning and ending vertices are not same) in which no vertex appears twice or more.
- **Euler Path:** A Euler path is a simple path in a graph which visits every edge of the graph exactly once.
- **Circuit:** A circuit is a path which ends at the same vertex where it begins.
- **Eulerian Graph:** A graph which contains either Euler path or Euler circuit is called Eulerian Graph.
- **Hamiltonian Path:** A path which contains each vertex of graph exactly once is called Hamiltonian path.
- **Hamiltonian Circuit:** A circuit that contains each vertex of graph exactly once except for the first and the last vertex is called Hamiltonian circuit.
- **Hamiltonian Graph:** A graph which contains either Hamiltonian circuit or Hamiltonian path is called Hamiltonian graph.
- **Directed Graph:** A Di-Graph or Directed Graph consists of a vertex set V and an edge set E such that each edge e in E is associated with an ordered pair of vertices. So, if is a function then it assigns every edge to a ordered pair of vertices.
- The difference of directed graph and the graph is in directed graph we use arrow sign in the edges means it has direction.

Applications of Graph Theory

The ideas and concepts of Graph theory are widely used in various branches of science and technology. In general, without knowing the concepts of graph we also use these in our day to day life. For example when we have to go to a place which is connecting with our starting point by different ways then we use the shortest road to arrive the destination soon. Here if we observe this problem from the point of view of graph theory the two places can be considered as vertices and roads are as edges. If we also consider the direction of travel, then the graph must be directed. Similarly, we can use these concepts of graph theory in various situations. A graph can be used to present almost any physical situation involving discrete and relationship among them. Here we are now going to discuss the applications of graph theory in various branches of science and technology.

Applications in Computer Science

There is a major role of graph theory in computer science. Graph theory concepts are used to develop the algorithm of different programs. Using these algorithms and programs we can solve different theoretical problems. There are some algorithms listed below:

- (1). Shortest path algorithm in a network.

- (2). Finding minimum spanning tree.
- (3). Finding graph planarity.
- (4). Algorithms to find adjacency matrices.
- (5). Algorithms to find the connectedness.
- (6). Algorithms to find the cycles in a graph etc.

There are many computer languages which help to solve different problems using graph theory concepts. Some computer languages available are

- (1). GTPL - Graph Theoretic Language.
- (2). GASP - Graph Algorithm Software Package.
- (3). HINT - Extension of LISP.
- (4). GRASPE - Another extension of LISP.
- (5). DIP - Directed Graph Processor.
- (6). An interactive Graph Theory System - Extension of FORTRAN.
- (7). GEA - Graphic Extended ALGOL.
- (8). GIRL - Graph Information Retrieval Language.
- (9). FGRAAL - FORTRAN Extended Graph Algorithmic Language.
- (10). AMBIT/G - Extension of AMBIT.

Applications in Operation Research

Graph theory is a very useful tool in operation research. There are some OR problems that can be solved using graphs. In transportation problem, when we need to minimize the transportation cost or maximize the profit, then the graph theoretical approach is very useful. It is also used in different assignment problems such as assigning different people to different jobs, Manage of time table for school, college etc.

Applications in Google map

Now a days, Google map is a very useful tool for travelling anywhere in the world. Using google map we can find all routes from any place to any other place and also can find the shortest route. In case of Google map, we can consider the places as vertices of graph and the routes as the edges. Then the software of Google map, when find the routes between two places it find all edges between these two places or vertices and also gives the shortest edge as the shortest path.

Applications in Internet

Internet is a very useful invention of modern science. In the working technique of internet the

concepts of graph theory are used. In case of connectivity of internet, all the users are considered as vertices and the connection between them are edges. Then all internet users form a very complicated graph and data and information from one user to another user are shared through the shortest route in between them. Similarly, in case of social networking sites one friend is connected to all of his friend and his friends are also connected to others. If we consider the friends as vertices of graph and draw an edge in between them if they are friend then it will be a graph.

Applications in Chemistry

Graph theory is used in chemistry for mathematical modeling of chemical phenomena. We can make natural model of a molecule where vertices represent atoms and edges represent bond. There is a branch of mathematical chemistry called Chemical graph theory (CGT) which deals with the non-trivial applications of graph theory to solve molecular problems. The pioneers of the chemical graph theory are Alexander Balaban, Ante Graovac, Ivan Gutman, Haruo Hosoya, Milan Randić and Nenad Trinajstić and others. Graph theory is also used in computational biochemistry.

Applications in Physics

Graph theory is also used in the field of physics. Generally, graph theory concepts are used in different electrical circuits. The current, voltage and resistance on a circuit can be drawn by using graph theory concept. When we want to show the flow of current in circuits then we can use directed graphs. Also we can connect the different physical process with the help of graph theory concepts.

Applications in logistic

The graph theory is a very adequate tool for resolving logistical problems. Let us highlight some of the problems that are resolved through the graph theory and are applicable for modeling of some problems in logistics which are appearing in everyday life: The Chinese postman problem is an example in which we are trying to search for a walk so that we go through every connection in the graph only once and do so in the shortest possible way, using the directed or undirected graph. For better understanding we could imagine a postman who is walking the streets (in our case the graph) and wants to deliver the mail for each house (vertices on the given graph) in the shortest time possible and then return to the post office (starting point). The postman is trying to save time, effort and money by finishing his job using the shortest route. The traveling salesman problem is very similar to the Chinese postman problem at the first sight. It considers the case in which we want search for a walk using directed or undirected graph in the way to cross every vertex of the graph at least once using the shortest possible way. The salesman has to visit all the vertices in the way that he uses the shortest path (the sum of all connections used must be minimal) and return to the starting point. We can imagine that a salesman starts at point a. If the distances between every pair of points are known the question is; what is the shortest route the salesman could take to visit all the other points and return to point a? Search for the minimum spanning tree considers the case in which we want components of unconnected graphs to be connected by using only some given edges. Search for the shortest path comes to use when we want to find the distance or the shortest way between two vertices in weighted graph. 9 Finally we could state that the problems mentioned above show us the problems of the real world very nicely. The solutions of the problems of the graph theory are also very likely to show us the solutions of

logistical problems in everyday life. For examples:

- The paths of the snowplows can be modeled with the help of the graph theory. For this purpose we usually use one of the variations of the Chinese postman problem.
- The construction of cable or electricity network, water supply lines etc. can be resolved with the search of minimum spanning tree.
- The routes and order of transporting goods from warehouses to shops can be modeled with the merchant problem.
- The planning of the phone cable network that is connecting several different objects is modeled with the search of minimum spanning tree.
- Searching for the shortest route is already one of the common problems in everyday life. The popular GPS technology is seen on many motor vehicles as a method of searching for the easiest way to determine the right path to the chosen point on the map.

Conclusion

The main objective of this article is to present the importance of graph theory in different branches of science and our everyday life . Here we have discussed only a few applications of graph theory. There are many application of graph theory in different branches like economics, logistics etc. Therefore graph theory has developed into a subject itself with variety of applications.

References

1. F.Harary, Graph Theory, Narosa Publishing House, (2013).
2. N.Deo, Graph Theory, Prentice Hall of India, Private Ltd, New Delhi, (2007).
3. S.G.Shrinivas, S.Vetrivel and N.M.Elango, Applications of graph theory in computer science an overview, International Journal of Engineering Science and Technology, 2(9)(2010), 4610-4621.
4. NarasinghDeo, Graph theory with applications to engineering and computer science, Prentice Hall of India, (1990).
5. J.A.Bondy, U.S.R.Murty, Graph theory with applications, The Macmillan Press Ltd., (1982).

12. The Domination in Graph Theory

National conference on
Graph Theory And It's Applications (NCGTA-2018)
 New Arts, Commerce And Science College, Parner
 INDIA, 19-20, Jan. 2018 ISBN: 978-81-930155-0-9

The Domination In Graph Theory

Mr. Saurabh Radhakisan Shinde

Asst.Prof. Department of Mathematics,
 New Arts, Commerce and Science College, Parner, Dist. – Ahmednagar
 Savitribai Phule, Pune University, Pune (INDIA)
shindesaurabh21@gmail.com

Abstract:We now introduce concept of domination in graph theory.

Introduction:

Domination means, a set D of vertices from graph G called dominating set if every vertex not in D is adjacent to at least one vertex in D . Graph Theory is one of the most flourishing branches of modern mathematics and computer applications. From last many years tremendous growth of graph theory due to its wide applications to discrete optimization problems, combinatorial problems. It has very wide range of applications to many fields like engineering and all other sciences. The theory of Dominations has been the nucleus to research activity in graph theory in recent times. The study of domination in graphs came from study of games and recreational mathematics. Domination means, a set D of vertices from graph G called Dominating set if every vertex not in D is adjacent to at least one vertex in D . Domination is a concept which is also known as coding theory. If we define a graph G and $V(G)$ is the set of n -dimensional vectors with co-ordinates chosen from $\{1,2,3,\dots,q\}$ and for which $V'(G)$ is the set of pairs of vectors from $V(G)$ which differ in one co-ordinate then the set of vectors i) (n,q) covering sets ii) single error correcting codes iii) perfect covering sets are all dominating sets of G with certain additional properties.

• Graph-Theoretic Definitions:

In particular, mathematicians studied how chess pieces of a particular type could be placed on a chessboard in such a way that they would attack, or dominate, every square on the board. With this in mind, graph theoretical definitions will be related to the game of chess where applicable.

Envision a standard 8×8 chessboard, as can be seen in Figure 1. Each square can be represented by a vertex in a graph G . Consider placing several queens on the board. A queen may move any number of spaces vertically, horizontally, or diagonally. Any square (or vertex) to which a queen is able to move is adjacent to the square containing the queen. Therefore, there is an edge between those two squares, or vertices of the graph G . Since the chessboard is 8×8 , with each square represented by a vertex of the graph G , the order of G is 64. The size of G depends on the number, type, and placement of chess pieces on the board. **(Figure 1)**

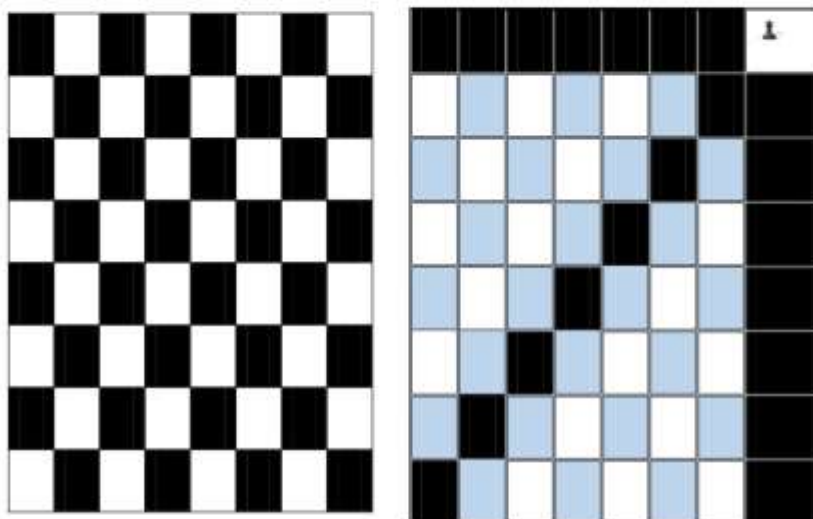

Figure1. The first image depicts a standard 8 × 8 chessboard. The second image has a queen placed in the upper right corner. If we represent every square on the board by a vertex in a graph, then we would draw an edge from the queen to every vertex representing one of the shaded squares.

Consider, once again, placing several queens on a chessboard. Assume the space occupied by one of the queens is denoted by vertex v . Then the number of possible moves for the queen occupying that space, including those occupied by other queens, is equal to $\text{deg}(v)$. If we count the number of possible spaces to which the queen in Figure 1 can move, we see that it has 21 possible moves. Thus, if we represent that chessboard by a graph and denote the space containing the queen as vertex v , we have $\text{deg}(v) = 21$. The degree of a vertex v , denoted $\text{deg}(v)$ is the number of edges incident with v . alternatively, we can define $\text{deg}(v) = |\text{In}(v)|$.

• **(1, 2)–Domination:**

A new type of dominating set, (1, 2)–dominating set is introduced by Steve Hedetniemi and Sandee Hedetniemi. In this paper we also present some basic theoremson these sets and the relation between the usual domination and (1, 2) -

domination. A $(1, 2)$ -dominating set in a graph $G = (V, E)$ is a set S having the property that for every vertex v in $V-S$ there is at least one vertex in S at distance 1 from v and a second vertex in S at distance at most 2 from v . The order of the smallest $(1, 2)$ -dominating set of G is called the $(1, 2)$ -domination number of G . From the definition of $(1, 2)$ -dominating sets, we see that a $(1, 2)$ -dominating set contains at least 2 vertices, $(1, 2)$ -domination number of a graph will be always ≥ 2 and $(1, 2)$ -dominating sets occur in graphs of order at least 3.

Applications of Domination in Graph

Domination in graphs has applications to several fields. Domination arises in facility location problems, where the number of facilities (e.g., hospitals, fire stations) is fixed and one attempts to minimize the distance that a person needs to travel to get to the closest facility. A similar problem occurs when the maximum distance to a facility is fixed and one attempts to minimize the number of facilities necessary so that everyone is serviced.

- School Bus Routing
- Locating Radar Stations Problem
- Modelling Social Networks
- Facility Location Problems
- Coding Theory
- Computer Communication Networks:
- Radio Stations:

CONCLUSION :

The main aim of this project is to present the importance of graph theoretical ideas in various areas of Science & Engineering for researches that they can use Domination in graph theoretical concepts for the research. An overview is presented especially to project the idea of graph theory. So, the graph theory section of each paper is given importance than to the other sections. Researches may get some information related to graph theory and its applications in various field and can get some ideas related to their field of research. Some theorems and results on the medium domination number of a graph are given. Also we found $(1, 2)$ -domination number of some graphs and compared them with the domination number. Also some preliminary theorems on $(1, 2)$ -dominating sets are proved.

REFERENCES :

1. R. B. Allan and R. C. Laskar. On domination and independent domination numbers of a graph. *Discrete Math.*, 23:73-76, 1978.
2. C. Berge, *Theory of Graphs and its Applications*. Methuen, London, 1962.
3. B. Brežsar. On Vizing's conjecture. *Discuss. Math. Graph Theory*, 21(1):5-11, 2001.
4. Boštjan Brežsar, Vizing-like conjecture for the upper domination of Cartesian products of graphs - the proof. *Electron. J. Combin.*, 12:Note 12, 6 pp. (electronic), 2005.
5. Robert C. Brigham and Julie R. Carrington, Global Domination. *Domination in Graphs*. Edited by Teresa W. Haynes, Stephen T. Hedetniemi and Peter J. Slater. 301-320, 1998.
6. E. J. Cockayne, R. M. Dawes and S. T. Hedetniemi, Total domination in graphs. *Networks*, 10:211-219, 1980.
7. D. C. Fisher, Domination, fractional domination, 2-packing, and graph products. *SIAM J. Discrete Math.*, 7(3):493-498, 1994.
8. M. S. Jacobson and L. F. Kinch, On the domination number of products of graphs: I. *Ars Combin.* 18: 33-44, 1983.
9. W. W. Rouse Ball, *Mathematical Recreation and Problems of Past and Present Times*, 1892.
10. V. G. Vizing, Some unsolved problems in graph theory. *Uspehi Mat. Nauk*23:117-134, 1968.
11. H. B. Walikar, B. D. Acharya, and E. Sampathkumar. Recent developments in the theory of domination in graphs. *MRI Lecture Notes in Math.*, Mahta Research Instit., Allahabad, volume 1, 1979.

13. Survey of Graph Energy's

National conference on
Graph Theory And It's Applications (NCGTA-2018)
New Arts, Commerce And Science College, Parner
INDIA, 19-20, Jan. 2018 ISBN: 978-81-930155-0-9

Survey of Graph Energies

Mr. Medhekar Chandrashekhar V.¹, Miss. Borude Sujata A.² & Gavhane Hemant R.³

¹Asst.Prof. Department of Mathematics, Sarada College Ahmednagar, Ahmednagar

^{2, 3} Department of mathematics, N.A.C.S.College Parner, Maharashtra

Chandrashekhar294@gmail.com¹, sujataboudemathematics@gmail.com²,

hemantgavhane111@gmail.com³

.....

Abstract :

The graph energy is a graph–spectrum–based quantity, introduced in the 1970s. After a latent period of 20–30 years, it became a popular topic of research both in mathematical chemistry and in “pure” spectral graph theory, resulting in over 600 published papers. Eventually, scores of different graph energies have been conceived. In this article we provide the basic facts on graph energies, in particular historical and bibliographic data.

Keywords:Energy, Spectrum, Graph.

14. Application of Graph Theory in Electrical Circuit.

National conference on
Graph Theory And It's Applications (NCGTA-2018)
 New Arts, Commerce And Science College, Parner
 INDIA, 19-20, Jan. 2018 ISBN: 978-81-930155-0-9

Applications of Graph Theory in electric Circuit

Mrs. TawareArchanaM.
Asst.Prof. Department of Mathematics
N.A.C.S. College Parner, Tal-Parner,Dist-Ahmednagar.
Savitribai Phule University,Pune

Abstract:

Graph theory is helpful in various practical problems solving in circuit or network analysis and data structure. It leads to graph practically not possible to analyse without the aid of computer. In electrical engineering the word is used for edge, node for vertex and loop for circuit. An electrical network is the set of electronic components i.e. resistors, inductors and capacitors etc. Electric network analysis and synthesis are the study of network topology. Electric network problem can be represented by drawing graphs. In this paper, we present a circuit network in the concept of graph theory application and how to apply graph theory to model the circuit network.

Keywords: Graph theory, Adjacency matrix, Electrical circuit and analysis

Introduction

A connected graph without closed path i.e. tree was implemented by G.Kirchhoff in 1847 and he employed graph theoretical concept in the calculation of currents in network or circuits and was improved upon J.C.Maxwell in 1892.[4] Ever since, graph theory has been applied in electrical network analysis .An electrical network is a collection of components and device interconnected electrically .The network components are idealized of physical device and system, in order to for them to represent several properties, they must obey the Kirchhoff's law of currents and voltage. A graph representation of electrical network in terms of line segments or arc called edges or branches and points called vertices or terminals.

Basic Definition of Graph Theory

Graph:

A graph G is defined by $(V; E)$ where the elements of the set V are called vertices of graph G and the elements of the set E are called edges of graph G . A vertex is represented by a dot and an edge is represented by line segment connecting the dots associated with the edge.

Directed Graph:

If the edges of a graph direct one vertex to the other vertex, then the graph is called as a directed graph. Otherwise graph is called an undirected graph. In an undirected graph $G= (V, E)$, the edges are unordered pairs, and each edge e_1 in E is associated with two vertices v_1 and v_2 , and it is written as either $e_1= (v_1,v_2)$ or $e_1= (v_2, v_1)$.But, In a directed graph, each edge e_1 in E is associated with an ordered pairs of vertices (v_1, v_2) and it is denoted the directed edge e_1 from v_1 to v_2 . Two vertices

v_1 and v_2 of a graph are adjacent, if there is an edge, v_1v_2 connecting them, then vertices are them considered incident to the edge v_1v_2 .

Analysis of Electrical Circuit

Ohm's law states that for an edge 'e', the current flowing across that edge e is given by $i_e = V/R$ We see that this means that $i\{uv\} = -i\{vu\}$ and the negative current as positive currents flowing the different way. The weight of an edge as the conductance of that edge, which Both the resistance and conductance are independent of edge such as $r\{vu\} = r\{uv\}$ and $c\{uv\} = c\{vu\}$.

Kirchhoff's Circuit Law

Kirchhoff's voltage law states that for a closed loop $\sum V = 0$ or $\sum V$ rise is equal to $\sum V$ drops. The total resistance of 'n' resistors in series is $R_T = R_1 + R_2 + R_3 + \dots + R_n$ and the total power are $P_T = P_1 + P_2 + P_3 + \dots + P_n$ series, So that the same current flows through all the components but a different potential voltage can exist across every one. In parallel, so that the same potential difference exists across every components but each component may carry a different current.

Representation of circuit and its graph:

A graph model is used to represented circuit network inn graph by tracing the nodes of the circuit and edges contain in circuit.

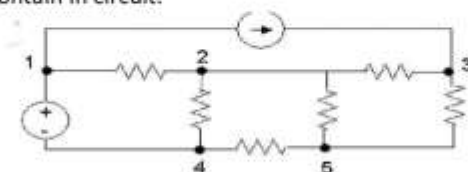

Here is the graph of the circuit

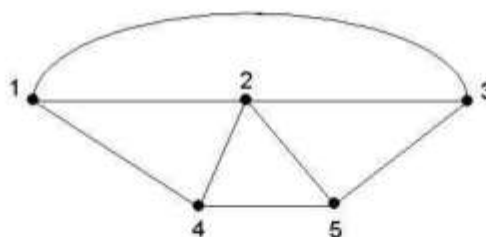

Figure 2

A circuit is a path which ends at the vertex it begins. An electric circuit is a closed loop formed by source, wires, load, and a switch, when switch is turned on the electrical circuit is complete and current flows from negative terminals of the power source. An electrical circuit is categories in to three type namely series, parallel and series and parallel circuit. The representation of graph in circuit network are one of the type of representation of graph in which the current flows in circuit and present the linking of connection.

Network graph between resistors series and parallel connection are determined in the circuit. The representation is

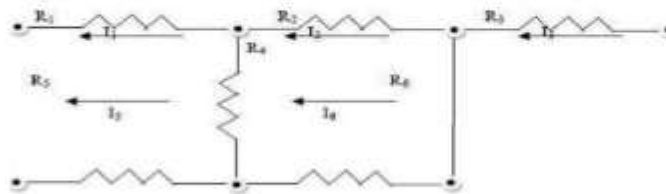
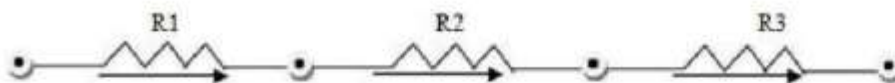

Figure 3

The schematic figure of the electric circuit is as follows,



Graph Representation of Matrix

A graph can actually be represented using matrices method the two of the most widely used matrices for graph representation is adjacency and incidence matrices. An adjacency matrix is a square matrix in which each row and column is represented by a vertex. Consider figure 4, as an example it has three vertices $V=\{ R1, R2,R3\}$ this mean that the square matrix must be 3x3 let each row and column is represented by each of the six vertices in V.

	R1	R2	R3
R1	0	1	0
R2	1	0	1
R3	0	1	0
R4	0	0	1
R5	0	0	0
R6	0	1	1

The adjacency matrix of 3x3 matrix square matrix represented as follows

$$G = \begin{bmatrix} 0 & 1 & 0 \\ 1 & 0 & 1 \\ 0 & 1 & 0 \\ 0 & 0 & 1 \\ 0 & 0 & 0 \\ 0 & 1 & 1 \end{bmatrix}$$

Conclusion

*National conference on
Graph Theory And It's Applications (NCGTA-2018)
New Arts, Commerce And Science College, Parner
INDIA, 19-20, Jan. 2018 ISBN: 978-81-930155-0-9*

In this research we focus on the application of graph theory to electrical network analysis and matrix approach as an electrical network analysis. Graph theory is a very interesting topic in mathematics due to numerous applications in various fields especially in computer and electrical engineering. We use the graph theory concept and techniques that we have developed to study electrical networks. Thus, graph theory has more practical application particulars in solving electric network.

References

1. Sudhakaran, Electrical circuit analysis, Tata Mc Grow-Hill Pvt Ltd.
2. B.Bollobas, Modern Graph Theory, Springer 1998.
3. Introductory Graph Theory for Electrical and Electronics Engineers, IEEMULTIDISCIPLINARYENGINEERING EDUCATION MAGAZINE.
4. NarasihDeo, Graph theory & its Application to computer science.

15. Application of Graph theory in combinatorics

National conference on
Graph Theory And It's Applications (NCGTA-2018)
New Arts, Commerce And Science College, Parner
INDIA, 19-20, Jan. 2018 ISBN: 978-81-930155-0-9

Application of Graph Theory in Combinatorics

Mrs. Anjali Suresh Tarade
Asst.Prof. Department of Mathematics
NACS College Parner, Dist-Ahmednagar
anjalitarade@gmail.com

.....

Abstract:

Graph theory plays an important role in to solve many real life problems. Graphs are basic objects in combinatorics. The questions range from counting e.g. the number of graphs on n vertices with k edges. There are strong connections between graph theory and combinatorics. In paper we used graph to solve combinatorics problems.

One of the oldest and most accessible parts of combinatorics is graph theory which by itself has numerous natural connections to other areas. Combinatorics is well known for the breadth of the problems it tackles. Combinatorial problems arise in many areas of pure mathematics. In this paper we used tree graph and complete bipartite graph to solve some combinatorics problems.

Keywords :Tree graph , Complete bipartite graph, Combinatorics.

16. Applications of Spectral Theory

National conference on
Graph Theory And It's Applications (NCGTA-2018)
 New Arts, Commerce And Science College, Parner
 INDIA, 19-20, Jan. 2018 ISBN: 978-81-930155-0-9

Applications of Spectral Graph Theory

Mr. DipakVishwanath Dhokrate¹& Mr. Deepak Damodhar Pathave²

¹Asst.Prof. Department of Mathematics,
 Adv. M. N. Deshmukh Arts, Science & Commerce College, Rajur,
 Tal-Akole Dist.- Ahmednagar,SavitribaiPhule Pune University, Pune (INDIA)

²Asst.Prof. Department of Mathematics,
 New Arts, Commerce and Science College, Parner, Dist. – Ahmednagar
 SavitribaiPhule Pune University, Pune (INDIA)
dipakdhokrat3@gmail.com¹&pathavedeepak@gmail.com²

Abstract:

There are numerous applications of mathematics, specifically spectral graph theory, within the sciences and many other fields. This paper is applications of spectral graph theory, including the fields of chemistry, biology, and graph colouring. Topics such as the isomers of alkanes, the importance of eigenvalues in protein structures, and the aid that the spectra of a graph provides when colouring a graph are covered, as well as others. The key definitions and properties of graph theory are introduced. Important aspects of graphs, such as the walks and the adjacency matrix are explored. In addition, bipartite graphs are discussed along with properties that apply strictly to bipartite graphs. The main focus is on the characteristic polynomial and the eigenvalues that it produces, because most of the applications involve specific eigenvalues. The maximum degree of the graph tells us the most carbon atoms attached to any given carbon atom within the structure. The Laplacian matrix and many of its properties are discussed at length, including the classical Matrix Tree Theorem and Cayley's Tree Theorem.

Introduction:

A **graph** $G = (V, E)$ is a pair of vertices V and a set of edges E , assumed finite i.e. $|V| = n$ and $|E| = m$. The set of edges may be empty. The **degree** of a vertex v , $\deg(v)$, is the number of edges incident on v . A graph is **regular** if all vertices have equal degrees. A graph is a **complete graph** if each pair of vertices is joined by an edge. In the example graph below,

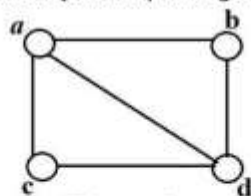

Figure-1

the set of vertices is $V(G) = \{a, b, c, d\}$ while the set of edges is $E(G) = \{ab, ac, ad, bd, cd\}$. The graph is not complete because vertices c and b are not joined by an edge. $\text{deg}(b) = 2 = \text{deg}(c)$, $\text{deg}(a) = 3 = \text{deg}(d)$. Two vertices are **adjacent** if there is an edge that connects them. In Figure-1, vertices a and b are adjacent, while vertices b and c are not.

A real world applications can be modeled using vertices and edges of a graph. Examples include electrical nodes and the wires that connect them, the stops and rails of a subway system and communication systems between cities.

The **order of G** is the cardinality of the vertex set $V(G)$. It is denote by $p(G)$ or p . The size of G is the cardinality of the edge set $E(G)$. It is denoted by $q(G)$ or q . A graph G can be denoted as a $G(p, q)$ graph.

A $v_i v_j$ **walk** in G is a finite sequence of adjacent vertices that begins at vertex v_i and ends at vertex v_j . In Figure-1, a walk from b to c would be bdc . The graph is **connected** if each pair of vertices in a graph is joined by a walk. The **distance** between any two vertices in a graph is the number of edges "traced" on the shortest walk between the two vertices. The distance from b to c is 2. The **diameter** of the graph G is the maximum distance between all of the pairs of vertices of a graph. It is denoted by $\text{diam}(G)$. In Figure-1, the distance between any two vertices is either 1 or 2, making $\text{diam}(G) = 2$. The vertices and edges may have certain attributes such as colour or weight. When the edges are given direction we have a **digraph** or **directed graph**. Digraphs can be used to model road maps. The vertices represent landmarks, while the edges represent one-way or two-way streets.

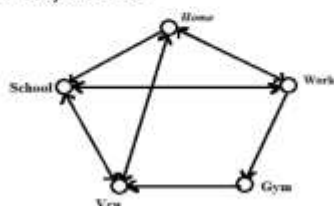

Figure-2

An **incidence matrix** associated with a digraph G is a $q \times p$ matrix whose rows represent the edges and columns represent the vertices. If an edge k starts at vertex i and ends at vertex j , then row k of the incidence matrix will have +1 in its (k, i) element and -1 in its (k, j) element. All other elements are 0.

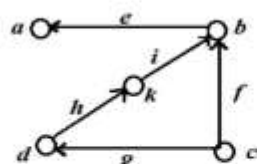

Figure-3

$$I = \begin{matrix} & \begin{matrix} a & b & c & d & k \end{matrix} \\ \begin{matrix} e \\ f \\ g \\ h \\ i \\ k \end{matrix} & \begin{bmatrix} -1 & 1 & 0 & 0 & 0 \\ 0 & -1 & 1 & 0 & 0 \\ 0 & 0 & 1 & -1 & 0 \\ 0 & 0 & 0 & 1 & -1 \\ 0 & 0 & 0 & -1 & 1 \end{bmatrix} \end{matrix}$$

A graph is called as **multi-graph** if two vertices are joined by more than one edge.

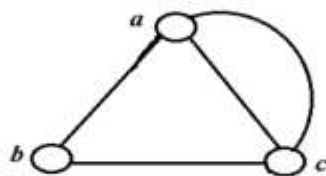

Figure-4

When a pair of vertices is not distinct, then there is a self-loop. A graph that admits multiple edges and loops is called a **pseudograph**. In the pseudograph below, edge *aa* is joining a pair of non-distinct vertices. Therefore, there is a self-loop at vertex *a*.

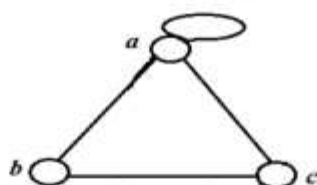

Figure-5

Graphs *G* and *H* are **isomorphic** if there is a vertex bijection $f: V(G) \rightarrow V(H)$ such that for all $u, v \in V(G)$, u and v adjacent in *G* \leftrightarrow $f(u)$ and $f(v)$ are adjacent in *H*.

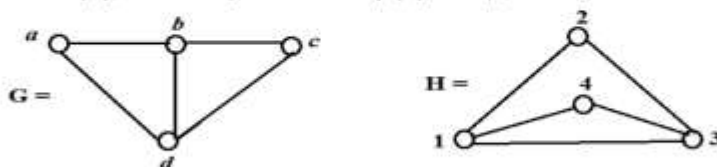

Figure-6

Graphs *G* and *H* are isomorphic, because a vertex bijection between them is: $f(a) = 2$, $f(b) = 3$, $f(c) = 4$, and $f(d) = 1$.

There is a great deal of importance and application to representing a graph in matrix form. One of the key ways to do this is through the **adjacency matrix**. The rows and columns of an adjacency matrix represent the vertices and the elements tell whether or not there is an edge between any two vertices. Given any element,

$$a_{ij} = \begin{cases} 1 & \text{if } a_i \text{ and } a_j \text{ are connected} \\ 0 & \text{otherwise} \end{cases}$$

For example,

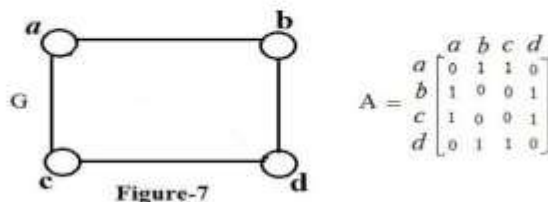

Figure-7

$$A = \begin{matrix} & \begin{matrix} a & b & c & d \end{matrix} \\ \begin{matrix} a \\ b \\ c \\ d \end{matrix} & \begin{bmatrix} 0 & 1 & 1 & 0 \\ 1 & 0 & 0 & 1 \\ 1 & 0 & 0 & 1 \\ 0 & 1 & 1 & 0 \end{bmatrix} \end{matrix}$$

Note that the diagonal of an adjacency matrix of a graph contains only zeros because there are no self-loops. Remember that our graphs have no multiple edges or loops. This causes the **trace** of the adjacency matrix $tr(\mathbf{A})$ is the sum of its main diagonal to be zero. Also, when \mathbf{A} represents a graph, it is square, symmetric and all of the elements are non-negative. In other words, $a_{ij} = a_{ji}$.

Result-1: The number of walks of length l from v_i to v_j in G is the element in position (i, j) of the matrix \mathbf{A}^l .

For example,

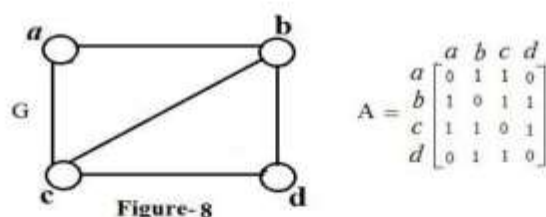

$$\mathbf{A} = \begin{matrix} & \begin{matrix} a & b & c & d \end{matrix} \\ \begin{matrix} a \\ b \\ c \\ d \end{matrix} & \begin{bmatrix} 0 & 1 & 1 & 0 \\ 1 & 0 & 1 & 1 \\ 1 & 1 & 0 & 1 \\ 0 & 1 & 1 & 0 \end{bmatrix} \end{matrix}$$

The number of walks from vertex b to vertex d of length 2 can be found by squaring matrix \mathbf{A} .

$$\mathbf{A}^2 = \begin{matrix} & \begin{matrix} a & b & c & d \end{matrix} \\ \begin{matrix} a \\ b \\ c \\ d \end{matrix} & \begin{bmatrix} 2 & 1 & 1 & 2 \\ 1 & 3 & 2 & 1 \\ 1 & 2 & 3 & 1 \\ 2 & 1 & 1 & 2 \end{bmatrix} \end{matrix}$$

Therefore if we look at element $(b, d) = \text{element}(d, b) = 1$. There is one walk from b to d of length 2. That walk is bcd .

Result-2: The trace of \mathbf{A}^2 is twice the number of edges in the graph.

In our example in Figure 8, the trace of \mathbf{A}^2 is 10 and the number of edges is 5.

Result-3: The trace of \mathbf{A}^3 is six times the number of triangles in the graph.

In our example in Figure 8,

$$\mathbf{A}^3 = \begin{bmatrix} 2 & 5 & 5 & 2 \\ 4 & 4 & 5 & 5 \\ 5 & 4 & 4 & 4 \\ 2 & 5 & 5 & 2 \end{bmatrix}$$

The trace of \mathbf{A}^3 is 12 and the number of triangles in the figure is 2.

The **characteristic polynomial** of a graph G of order n is the determinant $\det(A - \lambda I)$, where I is the $n \times n$ identity matrix and A is adjacency matrix of graph G . The general form of any characteristic polynomial is $\lambda^n + c_1\lambda^{n-1} + c_2\lambda^{n-2} + \dots + c_n$.

Result-3: The coefficients of the characteristic polynomial that coincide with matrix A of a graph G have the following characteristics:

- i) $c_1 = 0$
- ii) $-c_2$ is the number of edges of G
- iii) $-c_3$ is twice the number of triangles in G .

In our example in **Figure 8**, the characteristic polynomial is $\det(A - \lambda I) = \lambda^4 - 5\lambda^2 - 4\lambda$

- i) There is no λ^3 , so $c_1 = 0$
- ii) The number of edges of G is 5 because $-c_2 = 5$
- iii) The number of triangles in G is 2 because $-c_3 = 4$, so

The roots of a characteristic polynomial are called the **eigenvalues**. Setting the characteristic polynomial $\det(A - \lambda I) = \lambda^4 - 5\lambda^2 - 4\lambda$ equal to zero and solving we get the eigenvalues $\{-1, -1, 2\}$.

Result-4: The sum of the eigenvalues of a matrix equals its trace.

The **algebraic multiplicity** of an eigenvalue is the number of times that the value occurs as a root of the characteristic polynomial. The **geometric multiplicity** is the dimension of the **eigenspace** or the subspace spanned by all of the eigenvectors.

Result-5: If a matrix is real symmetric, then each eigenvalue of the graph relating to that matrix is real.

Result-6: The geometric and algebraic multiplicities of each eigenvalue of a real symmetric matrix are equal.

Result-7: The eigenvectors that correspond to the distinct eigenvalues are orthogonal.

Note that when u and v are two orthogonal eigenvectors of A associated with two distinct eigenvalues λ and μ then the unit vectors $\frac{u}{\|u\|}$ and $\frac{v}{\|v\|}$ are orthonormal eigenvectors associated with λ and μ respectively.

Result-8: If a graph is connected, the largest eigenvalue has multiplicity of 1.

Spectral graph theory is a study of the relationship between the topological properties of a graph with the spectral (algebraic) properties of the matrices associated with the graph. The most common matrix that is studied within spectral graph theory is the adjacency matrix. Originally, spectral graph theory analyzed the adjacency matrix of a graph, especially its eigenvalues.

The **spectrum** of a graph G is the set of eigenvalues of G , together with their **algebraic multiplicities**, or the number of times that they occur.

Result-9: A graph with n vertices has n eigenvalues.

If a graph has k distinct eigenvalues $\lambda_1 > \lambda_2 > \dots > \lambda_k$ with multiplicities $m(\lambda_1), m(\lambda_2), \dots, m(\lambda_k)$, then the spectrum of G is written

$$Spec(G) = \left(\begin{matrix} \lambda_1 & \lambda_2 & \dots & \lambda_k \\ m(\lambda_1) & m(\lambda_2) & \dots & m(\lambda_k) \end{matrix} \right) \text{ where } \sum_{i=1}^k \lambda_i = n.$$

For example,

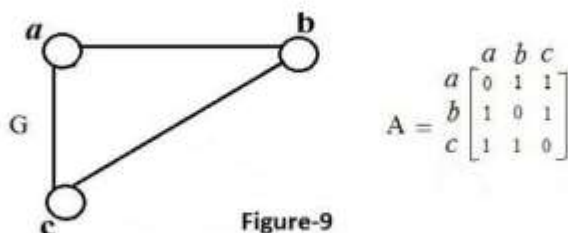

Figure-9

The characteristic polynomial is $\lambda^3 - 3\lambda - 2$ with eigenvalues $\{-1, -1, 2\}$. Our graph has two distinct eigenvalues: -1 and 2, hence the spectrum of the graph G is given by

$$Spec(G) = \left(\begin{matrix} -1 & 2 \\ 2 & 1 \end{matrix} \right)$$

A graph is **connected** if for every pair of vertices u and v , there is a walk from u to v . When we have a k -regular graph (all vertices have degree k), then $\lambda_1 = k$. When we have a complete graph (all vertices are adjacent to one another) with n vertices, $\lambda_1 = n - 1$. If G is a connected graph then λ_1 is less than or equal to the largest degree of the graph. Also, λ_1 increases with graphs that contain vertices of higher degree. In addition, the degrees of the vertices adjacent to the vertex with the largest degree affect the value of λ_1 .

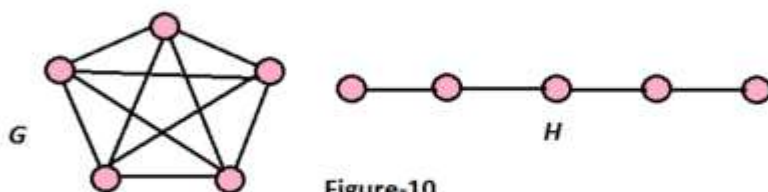

Figure-10

Both have 5 vertices. The degree of each vertex in G is 4. In other words, G is a complete graph, so $\lambda_1(G) = 4$. The second graph H is a path, the degrees of the vertices of H are 1 and 2, much smaller than that of G : $\lambda_1(H) = 3 \approx 1.732$.

A **bipartite graph** G is one whose vertex-set V can be partitioned into two subsets U and W such that each edge of G has one endpoint in U and one in W . The pair U, W is called the **bipartition** of G , and U and W are called the **bipartition subsets**.

Result-10: A graph is bipartite if and only if it contains no odd cycles.

Result-11: If G is a bipartite graph and λ is an eigenvalue then $-\lambda$ is also an eigenvalue.

Result-12: The spectrum of a bipartite graph is symmetric around 0.

Result-13: If G is a bipartite graph then $c_{2k-1} = 0$ for $n \geq 1$.

A **minimal polynomial** of a graph G is the monic polynomial $q(x)$ of smallest degree such that $q(G) = 0$.

Result-14: The degree of the minimal polynomial is larger than the diameter.

Result-15: If a graph G has diameter d and has m distinct eigenvalues then $m > d + 1$.

A **complete graph** is one in which every pair of vertices is joined by an edge. A complete graph with n vertices is denoted by K_n .

Result-16: The complete graph is the only connected graph with exactly two distinct eigenvalues.

Result-17: The complete graph K_p is determined by its spectrum.

The **Laplacian** L of a graph is the square matrix that corresponds to the vertices of a graph. The main diagonal of the matrix represents the degree of the vertex while the other entries are as follows:

$$A_{ij} = \begin{cases} -1 & \text{if } v_i \text{ and } v_j \text{ are adjacent} \\ 0 & \text{otherwise} \end{cases}$$

The Laplacian can also be derived from $D - A$, where D is the diagonal matrix whose entries represent the degrees of the vertices and A is the adjacency matrix.

For example,

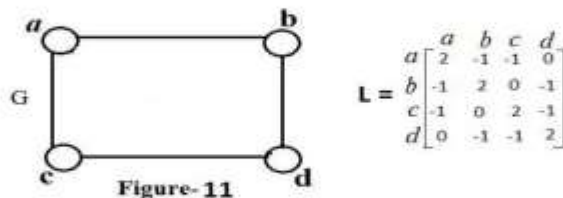

The Laplacian of a connected graph has eigenvalues $\lambda_1 \leq \lambda_2 \leq \dots \leq \lambda_n$. The algebraic connectivity is defined to be λ_2 , the second smallest eigenvalue. The name is a result of its connection to the vertex connectivity and the edge connectivity of a graph.

The Laplacian concerns the number of spanning trees of a graph. The Matrix Tree Theorem is one of the most significant applications of the Laplacian and is usually attributed to Kirchhoff. It is discussed in the next section.

A positive semidefinite matrix is one that is Hermitian, and whose eigenvalues are all non-negative. A Hermitian matrix is one which equals its conjugate transpose. This is usually written: $A^H = \overline{A^T} = A$.

The characteristic function is the function for which every subset N of X , has a value of 1 at points of N , and 0 at points of $X - N$. In other words, it takes the value of 1 for numbers in the set and 0 for numbers not in the set.

Result-18: The smallest eigenvalue of L is 0.

Result-19: The multiplicity of 0 as an eigenvalue of L is the number of connected components in the graph.

Result-20: The algebraic connectivity is positive if and only if the graph is connected.

A tree is a connected graph that has no cycles.

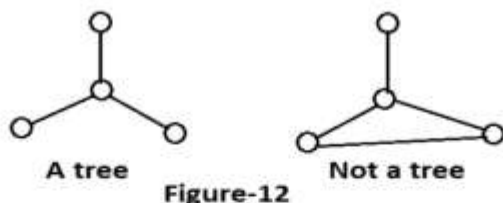

A subgraph H of a graph G is a graph whose vertex and edge sets are subset of $V(G)$ and $E(G)$ in that order. Some subgraphs of the tree above are

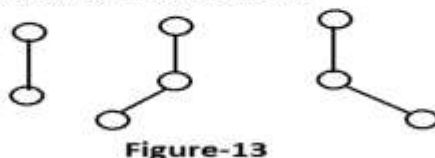

A subgraph H is said to **span** a graph G if $V(H) = V(G)$. A **spanning tree** of a graph is a spanning subgraph that is a tree. Given graph G below, graph H is a spanning tree of G .



Figure-14

Result-21(The Matrix Tree Theorem): Given a graph G , its adjacency matrix A and its degree matrix C , the number of nonidentical spanning trees of G is equal to the value of any cofactor of the matrix $C - A$.

Result-22(Cayley's Tree Formula): The number of different trees on n labeled vertices is n^{n-2} .

Chemical Applications:

A chemical tree is a tree where no vertex has a degree higher than 4. Chemical trees are molecular graphs representing constitutional isomers of alkanes. If there are n vertices, each chemical tree represents a particular isomer of C_nH_{2n+2} . The first four are methane, ethane, propane, and butane. After that, the alkanes are named based on Greek numbers. For example, C_5H_{12} is pentane. Compounds whose carbons are all linked in a row, like the two below, are called **straight-chain alkanes**. For example, if $n = 1$, we have the graph in Figure-15, which represents methane.

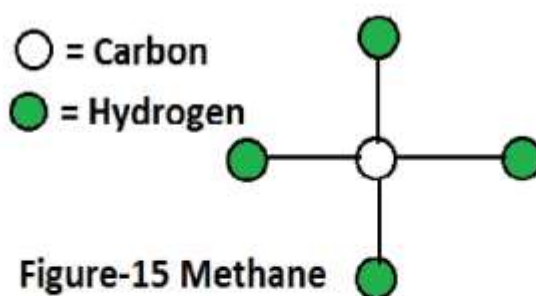

Figure-15 shows us butane, which is C_4H_{10} .

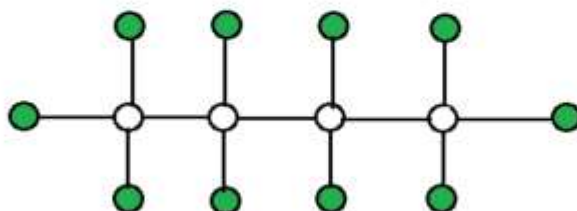

Figure-16 Butane

Compounds that have the same formula, but different structures, are called **isomers**. When C_4H_{10} is restructured as in Figure-17, we have isobutane or 2-Methylpropane. Butane and 2-Methylpropane are isomers.

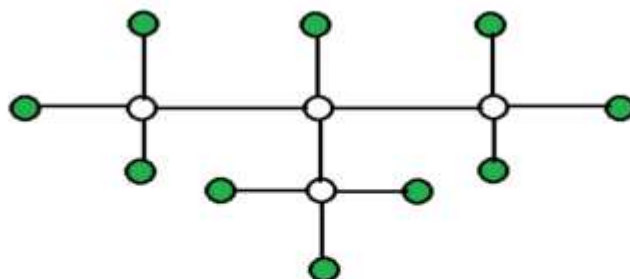

Figure-17 Isobutane or 2-Methylpropane

Compounds with four carbons have 2 isomers, while those with five carbons have 3 isomers. The growth, however, is not linear. The chart below compares the number of carbons with the number of isomers.

Formula	Number of Isomers
C_6H_{14}	5
C_7H_{16}	9
C_8H_{18}	18
C_9H_{20}	35
$C_{10}H_{22}$	75
$C_{15}H_{32}$	4347

When a carbon has four carbons bonded to it, we have a **quaternary** carbon. An example is below in Figure-18, which is called a 2,2-Dimethylpropane. It is isomeric to Pentane.

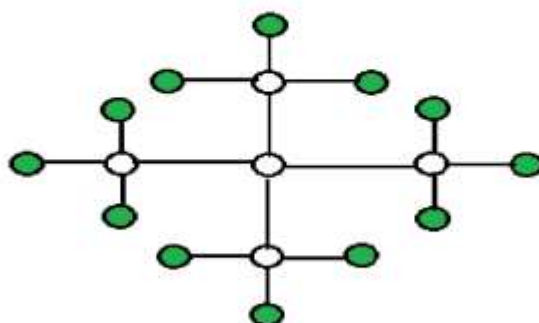

Figure-18 2,2-Dimethylpropane

For simplicities sake, we will just draw the carbon atoms from this point on, with the understanding that there are enough hydrogen atoms attached to each carbon to give that carbon atom a degree of 4.

Study was done on the eigenvalues of molecular graphs and in particular λ_1 (the largest eigenvalue of a graph). When the isomeric alkanes are ordered according to their λ_1 values, regularity is observed.

Let Δ denote the maximum degree of a graph. The chemical trees that pertain to the 18 isomeric octanes C_8H_{18} follow a pattern with respect to their largest eigenvalue λ_1 . The isomer with the smallest λ_1 (3.8478) value is the straight-chain octane in Figure-19, that has $\Delta = 2$.

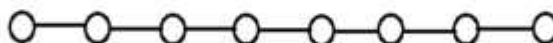

Figure-19

The next 10 isomers have various extensions of branching, but none possess a quaternary carbon atom. All of them have $\Delta = 3$ and their λ_1 's are greater than that of the straight-chain graph in Figure 4-5, where $\Delta = 2$ and less than the following seven, who have $\Delta = 4$. They are shown below in Figure-20.

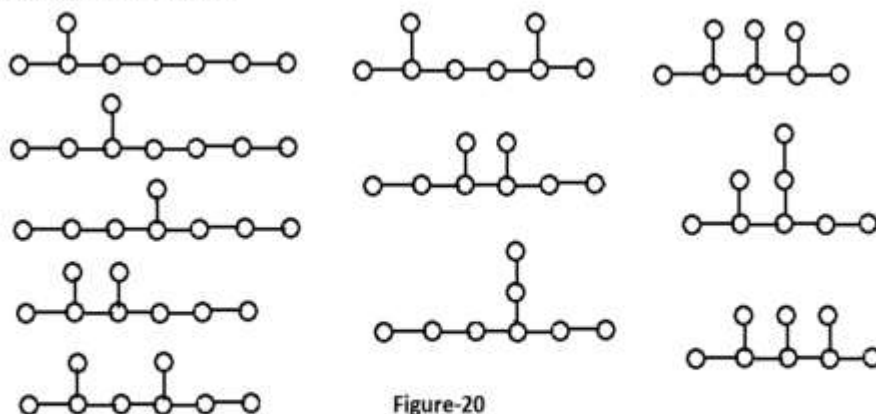

Figure-20

The 12th through the 18th octanes contain a quaternary carbon atom, they all have $\Delta = 4$, and they have the largest λ_1 . The largest one $\lambda_1 = 5.6458$ and is the last tree shown below in Figure-21.

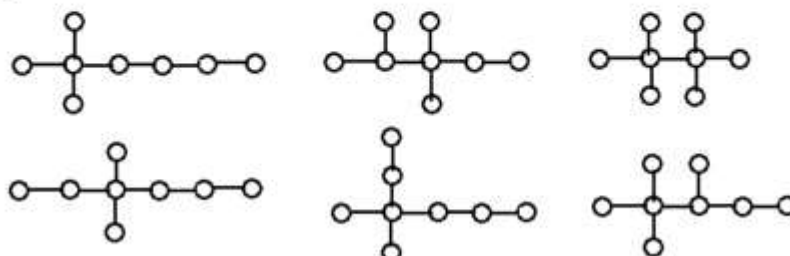

Figure-21

This same regularity occurs with isomeric alkanes with n carbon atoms, discussed above. The normal alkane with $\Delta = 2$ has the smallest λ_1 . All alkanes with $\Delta = 3$ have λ_1 greater than the alkanes with $\Delta = 2$, and smaller than any isomer with $\Delta = 4$. We can therefore draw the conclusion that Δ , which tells us whether or not there is a quaternary carbon atom, is the main molecular structure descriptor affecting the value λ_1 , the largest Laplacian eigenvalue of an alkane. It has been discovered that λ_1 can be bounded by

$$\Delta + 1 < \lambda_1 < \Delta + 1 + 2\sqrt{\Delta - 1}$$

Also, by using a linear combination of the lower and upper bounds, λ_1 can be estimated by

$$\lambda_1 \approx \Delta + 1 + \gamma \Delta - 1,$$

where γ depends on both n and Δ . For alkanes, it has been discovered through numerical testing that $\gamma \approx 0.2$. It is possible to establish the alkane isomers with $\Delta = 3$ or $\Delta = 4$ that have the minimal λ_1 . Give P_n , below, T_n^{min} is the tree that establishes the minimal λ_1 for $\Delta = 3$, and Q_n^{min} is the tree that establishes the minimal λ_1 for $\Delta = 4$.

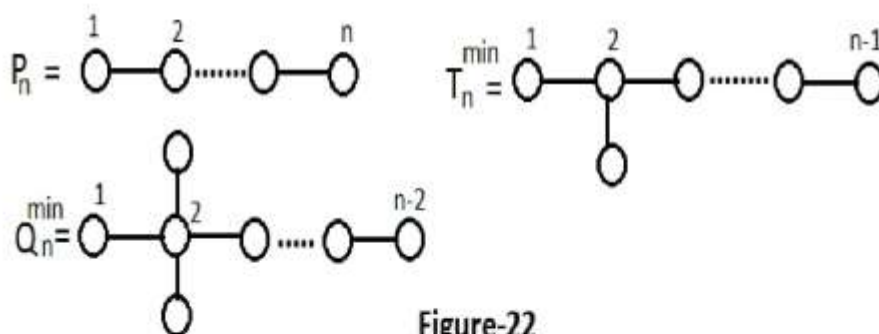

Figure-22

The structure trees that represent the maximal λ_1 are more complex. The T_n^{max} and Q_n^{max} coincide with the chemical trees that have the same Δ and n , having maximal λ_1 and minimal W , where W represents the Wiener topological index of alkanes and conforms to the formula $W = \lambda$. The exact characterizations of these trees are complex and will not be covered here.

National conference on
Graph Theory And It's Applications (NCGTA-2018)
New Arts, Commerce And Science College, Parner
INDIA, 19-20, Jan. 2018 ISBN: 978-81-930155-0-9

References:

1. Md. Saidur Rahman, Basic Graph Theory, Bangladesh University of Engineering and Technology (BEUT), Dhaka, Bangladesh.
2. J. A. Bondy and U. S. R. Murty. Graph Theory, volume 244 of Graduate Texts in Mathematics, Springer, 1st edition, 2008.
3. D.B. West. Introduction to Graph Theory. Prentice Hall of India, 2005.
4. Gary Chartrand and Linda Lesniak Graphs and Digraphs, Chapman & Hall, London, 1996.
5. Fan Chung, Spectral Graph Theory, American Mathematical Society, Providence RI, 1997.
6. Michael Doob, "Algebraic Graph Theory", Handbook of Graph Theory, Edited by Jonathan Gross and Jay Yellen. CRC Press, Boca Raton, FL, 2004.
7. Ivan Gutman, Dusica Vidovic, Dragan Stevanovic, Chemical Applications of the Laplacian Spectrum, *J. Serb Chemical Society* 67(6)407-413, February, 2002.
8. John McMurry, Organic Chemistry, 6th Edition. Thomson Learning, Inc, 2004.
9. Bojan Mohar Some Applications of Laplace Eigenvalues of Graphs, NATO ASI Seminar C 497, Kluwer, 1997.
10. Bojan Mohar The Laplacian Spectrum of Graphs, *Graph Theory, Combinatorics, and applications*, Vol 2, 1991 p 871-898.
11. Peter Oliver and Chehrzad Shakiban, Applied Linear Algebra, Pearson Prentice Hall, Upper Saddle River, NJ, 2006.
12. Jason Rosenhouse, Isoperimetric Numbers of Cayley Graphs Arising From Generalized Dihedral Groups, Kansas State University, November 19, 2002
13. Allen Schwenk Graph Theory and Linear Algebra Unpublished Lecture Notes, June 15-19, 1987.
14. Spectral Graph Theory Home Page, www.sgt.pep.ufrj.br, accessed March, 2008.
15. R.L. Graham, B.L. Rothschild, and J.H. Spencer. Ramsey Theory. Wiley Interscience in Discrete Mathematics, 1980.

17. Application of Graph Theory in Computer Science

National conference on
 Graph Theory And It's Applications (NCGTA-2018)
 New Arts, Commerce And Science College, Parner
 INDIA, 19-20, Jan. 2018 ISBN: 978-81-930155-0-9

Applications of Graph Theory In computer Science

Miss. Shinde Shubhangi Baban

Asst.Prof. Department of Mathematics,

B.P.H.E. Society's Ahmednagar College, Ahmednagar, Dist. – Ahmednagar
 Savitribai Phule, Pune University, Pune (INDIA)

Abstract:

A Graph has two main components: Vertices and Edges. The vertices are connected using edges. There are two types of graphs, directed and undirected. The major application of graph is representing network on paper.

Keywords: Graph, Directed, Undirected.

Introduction:

A Graph $G=(V,E)$ is a structure consisting of set of vertices $V=\{v_1,v_2,v_3,\dots\}$ and set of edges $E=\{e_1,e_2,e_3,\dots\}$ where each edge connect a pair of vertices.[1,2]

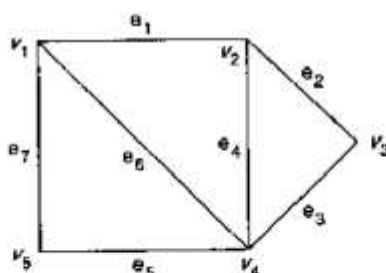

Figure 1. Example of a graph.

In Figure 1, we have $V=\{v_1,v_2,v_3,v_4,v_5\}$ and $E=\{e_1,e_2,e_3,e_4,e_5,e_6,e_7\}$. Edge e_1 connects vertices v_1 and v_2 . Vertices v_1 and v_2 are *adjacent* to each other as they are connected by a same edge.

Undirected-

An undirected graph is a graph in which edges have no orientation. The edge (x, y) is identical to the edge (y, x) , i.e., they are not ordered pairs, but sets $\{x, y\}$ (or 2-multisets) of vertices.

Directed-

A directed graph or digraph is a graph in which edges have orientations. An arrow (x, y) is considered to be directed from x to y ; y is called the head and x is called the tail of the arrow; y is said to be a direct successor of x and x is said to be a direct predecessor of y .

Graph as a Data Structure:

In computer science, a *graph* is an abstract data type that is meant to implement the undirected graph and directed graph concepts from mathematics. A graph data structure consists of a finite (and possibly mutable) set of vertices or nodes or points, together with a set of unordered pairs of these vertices for an undirected graph or a set of ordered pairs for a directed graph. These pairs are known as edges, arcs, or lines for an undirected graph and as arrows, directed edges, directed arcs, or directed lines for a directed graph. The vertices may be part of the graph structure, or may be external entities represented by integer indices or reference. A graph data structure may also associate to each edge some edge value, such as a symbolic label or a numeric attribute (cost, capacity etc.).

Graph Applications:

Graphs are used in many situations of reality, and tasks on graphs model multiple real problems that often need to be resolved. We will give just a few examples:

1. **Map of a city** can be modeled by a *weighted oriented graph*. On each street, edge is compared with a length, corresponding to the length of the street, and direction – the direction of movement. If the street is a two-way, it can be compared to two edges in both directions. At each intersection there is a node. In such a model there are natural tasks such as searching for the shortest path between two intersections, checking whether there is a road between two intersections, checking for a loop searching for a path with a minimum number of turns, etc.
2. **Computer network** can be modeled by an *undirected graph*, whose vertices correspond to the computers in the network, and the edges correspond to the communication channels between the computers.

Network Representation Using Graphs:

Examples of networks are: an arrangement of intersecting lines, or a group or system of interconnected people or things, a system of computers connected by communications lines (cables); a group of connected radio or television stations; *a network of roads, etc.*

Representing a problem as a graph can make a problem much simpler. More accurately, converting a network into graph can provide the appropriate tools for solving the problem.

Nodes and edges

In graph-like problems, these components have natural correspondences to problem elements - Entities are nodes and interactions between entities are edges, and the property for which the problem is considered, is taken as the cost of the edges (e.g. distance, traffic, etc.).



Figure 2.1. A graph of connected cities

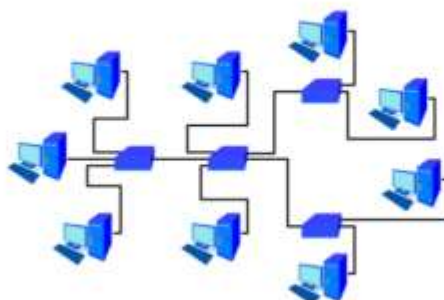

Figure 2.2. A graph of connected computer

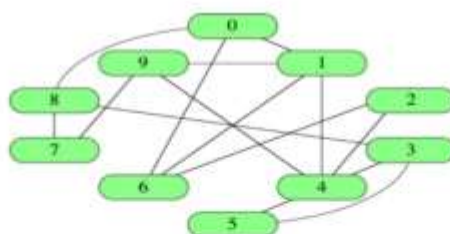

Figure graph 2.3. A social network graph.

References :

1. Germander Soothill (April 27, 2010). The Euclidean Steiner Problem.
2. Marshall W. Bern and Ronald L. Graham (January 1989). The shortest network problem, Scientific American.
3. E. N. Gilbert and H. O. Pollak (Volume 16 no. 1, January 1968). SIAM Journal of Applied Mathematics.
4. M.B.Chandak, R.Dharaskar, "Natural Language processing based context sensitive, content specific architecture and its speech based implementation for smart homes, International Journal of Smart homes, 4(2), 1-10, 2010.
5. F.Riaz, K.M.Ali, "Application of graph theory in Computer Science" Third International Conference on Computational Intelligence, Communication Systems and Networks.
6. H.Selim, P.Chopade, "Structural analysis and interactive visualization of large scale big data networks" IEEE 11th International Conference on Networking, Sensing and Control.
7. N.Lakshmi Prasanna, "Application of Graph labelling in communication networks" Oriental Journal of Computer Science and Technology" ISSN-09724-6471
8. Dr. S.M. Hegde, "Labeled graphs and Digraphs: Theory and Applications", 12-01-2012 Research Promotion Workshop on IGGA

18. Applications of Graphs in Real Line

National conference on
Graph Theory And It's Applications (NCGTA-2018)
 New Arts, Commerce And Science College, Parner
 INDIA, 19-20, Jan. 2018 ISBN: 978-81-930155-0-9

Applications of Graphs in Real-Life

Miss. UjjwalaSakharamChaudhari
 Asst.Prof. Department Of Mathematics,
 NACS College, Parner, Dist-Ahmednagar
 Savitribai Phule PuneUniversity,Pune
dhanshri2602@gmail.com

Abstract:

Graphs are becoming increasingly significant as it is applied to other areas of mathematics, science and technology. This paper gives an overview of the applications of theory in heterogeneous fields. It is being actively used in fields as varied as biochemistry, electrical engineering, computer science and operations research.

Introduction:

Graph theory is rapidly moving into the mainstream of mathematics mainly because of its applications in diverse fields which include biochemistry (genomics), electrical engineering (communications networks and coding theory), computer science (algorithms and computations) and operations research (scheduling). For example, a data structure can be designed in the form of tree which in turn utilized vertices and edges. Similarly modeling of network topologies can be done using graph concepts. In the same way the most important concept of graph coloring is utilized in resource allocation, scheduling. Also, paths, walks and circuits in graph theory are used in tremendous applications say traveling salesman problem, database design concepts, resource networking.

Applications:

Graphs in Biology:

Biology graphs are usually on higher level where nodes represent amino acids and edges represent connections or contacts among amino acids. In computational biochemistry there are many situations where we wish to resolve conflicts between sequences in a sample by excluding some of the sequences.

Map Coloring and GSM Mobile Phone Networks:

Groups Special Mobile (GSM) is a mobile phone network where the geographical area of this network is divided into hexagonal regions or cells. Each cell has a communication tower which connects with mobile phones within the cell. All mobile phones connect to the GSM network by searching for cells in the neighbors. Since GSM operate only in four different frequency ranges, it is clear by the concept of graph theory that only four colors can be used to color the cellular regions. These four different colors are used for proper coloring of the regions.

Computer Network Security:

A team of computer scientists led by Eric Filiol at the Virology and Cryptology Lab, ESAT, and the French Navy, ESCANSIC, have recently used the vertex cover algorithm to simulate the

propagation of stealth worms on large computer networks and design optimal strategies for protecting the network against such virus attacks in real-time.

Airline route maps:

Vertices represent airports, and there is an edge from vertex A to vertex B if there is a direct flight from the airport represented by A to the airport represented by B. Airlines use minimum spanning trees to work out their basic route system. Assuming that there are k aircrafts and they have to be assigned n flights. The i^{th} flight should be during the time interval (a_i, b_i) . If two flights overlap, then the same aircraft cannot be assigned to both the flights. This problem is modeled as a graph as follows. The vertices of the graph correspond to the flights. Two vertices will be connected, if the corresponding time intervals overlap. Therefore, the graph is an interval graph that can be colored optimally in polynomial time.

Conclusion:

The main aim of this paper is to present the importance of graph theoretical ideas in various areas of Real life. An overview is presented especially to project the idea of graph.

References:

1. "Planarizing Graphs", Journal of Graph Algorithms and Applications, [http://www.cs.brown.edu/publications/jgaa/vol. 5, no. 1, 2001](http://www.cs.brown.edu/publications/jgaa/vol.5, no.1, 2001).
2. ShariefuddinPirzada and AshayDharwadker, "Applications of Graph Theory", Journal of the Korean Society for Industrial and applied Mathematics, Volume 11, No.4,2007.
3. Alexandru T. Balaban, Journal of Chemical Information and Computer Science, 1985, 25 (3), pp 334–343 DOI: 10.1021/ci00047a033.
4. G. Lancia, V. Afna, S. Istrail, L. Lippert, and R. Schwartz,SNPsProblems, Complexity and Algorithms, ESA 2002, LNCS 2161, pp. 182-193, 2001. Springer-Verlag 2001.
5. AshayDharwadker, The Vertex Coloring Algorithm, 2006, http://www.dharwadker.org/vertex_coloring
6. AshayDharwadker, " a new proof of The four colour theorem", Institute of Mathematics, Haryana, India. <http://www.dharwadker.org/>
7. Eric Filiol, Edouard Franc, Alessandro Gubbioli, Benoit Moquet and Guillaume Roblot, Combinatorial Optimisation of Worm Propagation on an Unknown Network, Proc. World Acad. Science, Engineering and Technology, Vol 23, August 2007.

19. Application Of Graph Theory In Daily Human Life

National conference on
Graph Theory And It's Applications (NCGTA-2018)
 New Arts, Commerce And Science College, Parner
 INDIA, 19-20, Jan. 2018 ISBN: 978-81-930155-0-9

Application of Graph Theory in Daily Human Life

Miss. Nutan Tatyaba Mandge

Asst. Prof. Department of Mathematics,
 New Arts, Commerce and Science College, Parner, Dist. – Ahmednagar
 Savitribai Phule, Pune University, Pune (INDIA)
nutanmandge2226@gmail.com

Abstract:

Graphs are considered as an excellent modeling tool which is used to model many type of relations amongst any physical situation. Many problems of real world can be represented by graphs. This paper explores different concepts involved in graph theory and their applications in computer science to demonstrate the utility of graph theory. These applications are presented especially to project the idea of graph theory and to demonstrate its objective and importance in computer science engineering.

Keywords:

Graphs, connectivity, constraints, graph colouring, graph drawing, Web designing, Eulerian Graph, Four Colour Theorem, Hamiltonian Graph etc.

Introduction:

Graph theory is a branch of discrete mathematics. Graph theory is the study of graphs which are mathematical structures used to model pair wise relations between objects. A graph is made up of vertices V and edges E that connect them. A graph is an ordered pair $G = (V, E)$ consisting a set of vertices V with a set of edges E . Graph theory is originated with the problem of Koinsberg bridge, in 1735. This problem escort to the concept of Eulerian Graph. Euler studied the problem of Koinsberg Bridge and established a structure to resolve the problem called Eulerian graph. In 1840, A.F Mobius presented the idea of complete graph and bipartite graph and Kuratowski proved that they are planar by means of recreational problems. The concept of tree, by Gustav Kirchoff in 1845, and he enrolled graph theoretical ideas in the calculation of currents in electrical networks or circuits. In 1852, Thomas Gutherie established the famous four colour problem. Then in 1856, Thomas. P. Kirkman and William R. Hamilton measured cycles on polyhydra and contrived the concept called Hamiltonian graph by studying trips that visited certain sites exactly once [3]. In 1913, H.Dudeney mentioned a puzzle problem. Eventhough the four colour problem was invented it was solved only after a century by Kenneth Appel and Wolfgang Haken [10]. This is considered as origin of Graph Theory. In 1852, Thomas Gutherie established the famous four colour problem.

Applications Of Graph Theory In Everyday Life:

There is n-number of applications of graph theory, few are represented as follows:

1. GPS or Google Maps:

GPS to find a shortest route from one destination to another. The destinations are Vertices and their connections are Edges consisting distance. The optimal route is determined by the software. Schools/ Colleges are also using this technique to pick up students from their stop to school. Each stop is a vertex and the route is an edge. A Hamiltonian path represents the efficiency of including every vertex in the route.

2. Traffic lights :

The functioning of traffic lights i.e. turning Green/Red and timing between them. Here vertex colouring technique is utilized to solve conflicts of time and space by identifying the chromatic number for the number of cycles needed.

3. Social Networks:

We connect with friends via social media or a video gets viral, here user is a Vertex and other connected users create an edge therefore videos get viral when reached to certain connections.

4. Google Search:

While using Google to search for WebPages, Pages are linked to each other by hyperlinks. Each page is a vertex and the link between two pages is an edge.

Applications of Graph Theory In Technology:

1.1 Graphs in Computer Science

Data Mining: Data mining is process of perceiving required information from huge data with the help of various methods. Mostly the data we deal with in data science can be shaped as graphs. These graphs can be mined utilizing known algorithms and various techniques in graph theory to understand them in better way, e.g. in social networks every person in the network could be supposed as a vertex and any connection between them is supposed as an edge. Graph is captivating model of data backed with a strong theory and a set of quality algorithms to solve related problems.

1.2 GSM Mobile Phone Networks and Map Colouring:

All mobile phones connect to the GSM network by searching for cells in the neighbors. Since GSM operate only in four distinct frequency ranges, it is clear by the concept of graph theory that only four colours may be utilized to colour the cellular regions. These four different colours are used for proper colouring of the regions. The vertex colouring algorithm can be used to allocate at most four distinct frequencies for any GSM mobile phone network.

1.3 Web Designing:

Website designing can be modeled as a graph, where the web pages are entitled by vertices and the hyper links between them are entitled by edges in the graph. This concept is called as web graph. Other implementation areas of graphs are in web community. Where the vertices represent classes of objects, and each vertex representing one type of objects, and each vertex is connected to every vertex representing other kind of objects. In graph theory such a graph is called a complete bipartite graph. There are many benefits graph

theory in website development like: Searching and community discovery, Directed Graph is used in web site utility evaluation and link structure.

1.4 Graphs in Chemistry:

The structural formulae of covalently bonded compounds are graphs; they are known as constitutional graphs. Graph theory provides the basis for definition, enumeration, systematization, codification, nomenclature, correlation. The importance of graph theory for chemistry originates mainly from the existence of the phenomenon of isomerism, which is extenuated by chemical structure theory. This theory accounts for all constitutional isomers by using purely graph-theoretical methods.

Conclusion:

The objective of this paper is to investigate applications of graph theory in technology. This paper is valuable for students and researchers to get the overview of graph theory and its application in diverse fields like everyday life, computer science, Operation Research, Chemistry. There are many problems in this area which are yet to be examined. This review would magnetize many new researchers into graph theory.

References:

1. The role of data structure in multiple disciplines in computer science: A Review by N.Sobhna Rani and Suman S.P, International Journal of Scientific & Engineering Research, Volume 4, Issue 7, July-2013
2. Graph Databases: Adrian Silvescu, Doina Caragea, Anna Atramentov Artificial Intelligence Research Laboratory Department of Computer Science Iowa State University Ames, Iowa 50011
3. Applications of Graph Coloring in Modern Computer science by Shamim Ahmed (ijcit, issn 2078-5828 (print), ISSN 2218-5224 (online), volume 03, issue 02, manuscript code: 130101(2012)
4. Applications of graph theory in computer science an overview by S.G.Shirinivas, S.Vetrivel and Dr. N.M.Elango (International Journal of Engineering Science and Technology, Vol. 2(9), 2010, 4610-4621)
5. Graph theory application in developing software test strategies for networking system by Vladimir. V. Riabov (2007) 4-graph application to data structures by V.manjula (2012)
6. International Journal of Engineering Science and Technology Vol. 2(9), 2010, 4610-4621.

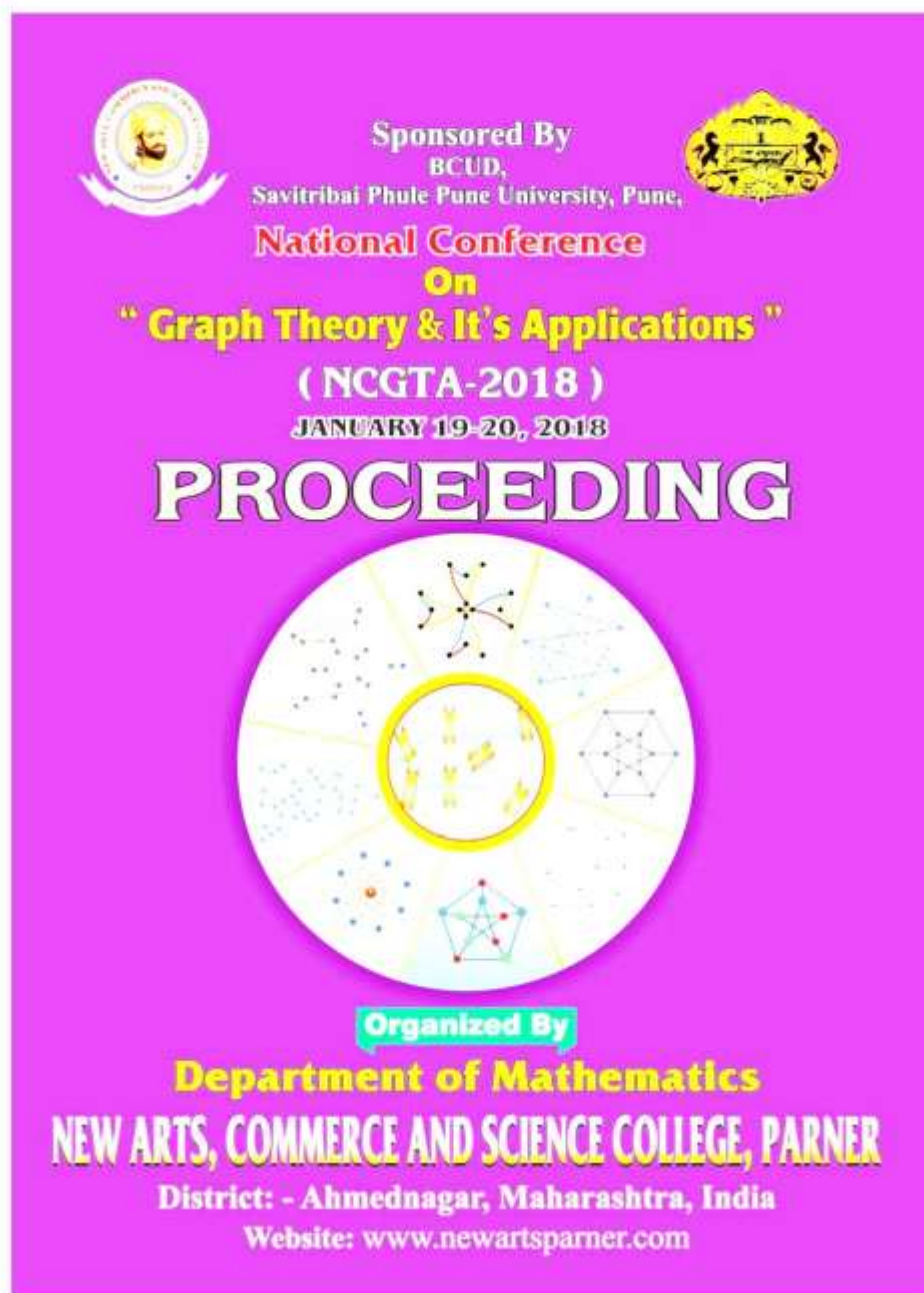
20. Applications of Graph Theory in Science and technology

National conference on
Graph Theory And It's Applications (NCGTA-2018)
New Arts, Commerce And Science College, Parner
INDIA, 19-20, Jan. 2018 ISBN: 978-81-930155-0-9

Applications of Graph Theory in Science And Technology

Mr. Gadage V. M.¹, Mr. Shinde S. A.² & Mr. Shinde R. A.³
Department of Mathematics¹, Department of Computer Science², Department of B.B.A.-C.A.³
N.A.C.S. College, Parner, Dist-Ahmednagar

Savitribal Phule Pune University, Pune

shindebhavivare@pmef.com

Abstract:

Graph theory is a branch of Mathematics which has wide application in other area of Mathematics as well as in other branches of Science and Technology. It has also significant role in our everyday life. In this article we have discussed the application of Graph Theory in our daily life and different branches of science and technology such as Mathematics, Physics, Chemistry, Biology, Computer science, Operation research, Engineering, logistic etc.

Keywords: Graph, Path, Eulerian Graph, Hamiltonian Graph, Tree, Network.

Introduction:

In the first part of this article, we discuss the history and origin of Graph theory and some definitions which are frequently used in studying this subject. The main origin of graph theory was the problem of Königsberg Bridge. The city Königsberg was on the both sides of the river Pregl and included two large islands which were connected to each other or to the city by seven bridges. There was a question in the mind of residents of Königsberg whether they could travel around the city, crossing each of the seven bridges once and only once. In 1736 Leonhard Euler (1707-1783) turned his mind to the problem of Königsberg Bridge and he came to the conclusion that it did not matter how a man walked around the land or where exactly bridges were, it was not possible to do this. This led to the concept of Eulerian graph. By solving this problem Euler introduced the new branch of mathematics namely Graph theory. In 1840, A.F. Möbius presented the idea of complete graph and bipartite graph. In 1845, Gustav Kirchhoff introduced the concept of tree and he applied the concept of tree in calculation of currents in electrical circuits. In 1852, Thomas Guthrie found the famous four color problem. In 1856, P. Kirkman and William R. Hamilton studied the cycles of polyhedra and invented the concept of Hamiltonian graph. Although the four color problem was invented it was not solved then. This problem was solved after a century by Kenneth Appel and Wolfgang Haken in 1976. It was the first major theorem to be proved using computer. The term Graph was introduced by Sylvester in 1878. This is how the graph theory was developed.

Preliminaries:

In this section, we have listed some important definitions frequently used in Graph theory.

National conference on
 Graph Theory And It's Applications (NCOTA-2018)
 New Arts, Commerce And Science College, Parner
 INDIA, 19-20, Jan, 2018 ISBN: 978-81-930155-8-9

- **Graph:** A graph G is defined by (V, E) where the elements of the set V are called vertices of graph G and the elements of the set E are called edges of graph G . Here is a function which assigns each edge of the graph G with two vertices.
- **Walk:** A walk on a graph is a finite alternating sequence of vertices and edges, beginning and ending with vertices, such that each edge is incident to its preceding and following vertices.
- **Length of Walk:** Length of a walk is given by the number of edges in the walk.
- **Trail:** A trail is a walk in which all edges are distinct.
- **Path:** A path or simple path is an open walk (walk whose beginning and ending vertices are not same) in which no vertex appears twice or more.
- **Euler Path:** A Euler path is a simple path in a graph which visits every edge of the graph exactly once.
- **Circuit:** A circuit is a path which ends at the same vertex where it begins.
- **Eulerian Graph:** A graph which contains either Euler path or Euler circuit is called Eulerian Graph.
- **Hamiltonian Path:** A path which contains each vertex of graph exactly once is called Hamiltonian path.
- **Hamiltonian Circuit:** A circuit that contains each vertex of graph exactly once except for the first and the last vertex is called Hamiltonian circuit.
- **Hamiltonian Graph:** A graph which contains either Hamiltonian circuit or Hamiltonian path is called Hamiltonian graph.
- **Directed Graph:** A Di-Graph or Directed Graph consists of a vertex set V and an edge set E such that each edge e in E is associated with an ordered pair of vertices. So, if f is a function then it assigns every edge to a ordered pair of vertices.
- The difference of directed graph and the graph is in directed graph we use arrow sign in the edges means it has direction.

Applications of Graph Theory

The ideas and concepts of Graph theory are widely used in various branches of science and technology. In general, without knowing the concepts of graph we also use these in our day to day life. For example when we have to go to a place which is connecting with our starting point by deferent ways then we use the shortest road to arrive the destination soon. Here if we observe this problem from the point of view of graph theory the two places can be considered as vertices and roads are as edges. If we also consider the direction of travel, then the graph must be directed. Similarly, we can use these concepts of graph theory in various situations. A graph can be used to present almost any physical situation involving discrete and relationship among them. Here we are now going to discuss the applications of graph theory in various branches of science and technology.

Applications in Computer Science

There is a major role of graph theory in computer science. Graph theory concepts are used to develop the algorithm of different programs. Using these algorithms and programs we can solve different theoretical problems. There are some algorithms listed below:

- (1). Shortest path algorithm in a network.

- (2). Finding minimum spanning tree.
- (3). Finding graph planarity.
- (4). Algorithms to find adjacency matrices.
- (5). Algorithms to find the connectedness.
- (6). Algorithms to find the cycles in a graph etc.

There are many computer languages which help to solve different problems using graph theory concepts. Some computer languages available are

- (1). GTPL - Graph Theoretic Language.
- (2). GASP - Graph Algorithm Software Package.
- (3). HINT - Extension of LISP.
- (4). GRASPE - Another extension of LISP.
- (5). DIP - Directed Graph Processor.
- (6). An interactive Graph Theory System - Extension of FORTRAN.
- (7). GEA - Graphic Extended ALGOL.
- (8). GIRL - Graph Information Retrieval Language.
- (9). FGRAAL - FORTRAN Extended Graph Algorithmic Language.
- (10). AMBIT/G - Extension of AMBIT.

Applications in Operation Research

Graph theory is a very useful tool in operation research. There are some OR problems that can be solved using graphs. In transportation problem, when we need to minimize the transportation cost or maximize the profit, then the graph theoretical approach is very useful. It is also used in different assignment problems such as assigning different people to different jobs, Manage of time table for school, college etc.

Applications in Google map

Now a days, Google map is a very useful tool for travelling anywhere in the world. Using google map we can find all routes from any place to any other place and also can find the shortest route. In case of Google map, we can consider the places as vertices of graph and the routes as the edges. Then the software of Google map, when find the routes between two places it find all edges between these two places or vertices and also gives the shortest edge as the shortest path.

Applications in Internet

Internet is a very useful invention of modern science. In the working technique of internet the

National conference on
Graph Theory And It's Applications (NCOTA-2018)
New Arts, Commerce And Science College, Parner
INDIA, 19-20, Jan, 2018 ISBN: 978-81-930135-0-0

concepts of graph theory are used. In case of connectivity of internet, all the users are considered as vertices and the connection between them are edges. Then all internet users form a very complicated graph and data and information from one user to another user are shared through the shortest route in between them. Similarly, in case of social networking sites one friend is connected to all of his friend and his friends are also connected to others. If we consider the friends as vertices of graph and define an edge in between them if they are friend then it will be a graph.

Applications in Chemistry

Graph theory is used in chemistry for mathematical modeling of chemical phenomena. We can make natural model of a molecule where vertices represent atoms and edges represent bond. There is a branch of mathematical chemistry called Chemical graph theory (CGT) which deals with the non-trivial applications of graph theory to solve molecular problems. The pioneers of the chemical graph theory are Alexander Balaban, Ante Graovac, Ivan Gutman, Haruo Hosoya, Milan Randić and Nenad Trinajstić and others. Graph theory is also used in computational biochemistry.

Applications in Physics

Graph theory is also used in the field of physics. Generally, graph theory concepts are used in different electrical circuits. The current, voltage and resistance on a circuit can be drawn by using graph theory concept. When we want to show the flow of current in circuits then we can use directed graphs. Also we can connect the different physical process with the help of graph theory concepts.

Applications in logistic

The graph theory is a very adequate tool for resolving logistical problems. Let us highlight some of the problems that are resolved through the graph theory and are applicable for modeling of some problems in logistics which are appearing in everyday life: The Chinese postman problem is an example in which we are trying to search for a walk so that we go through every connection in the graph only once and do so in the shortest possible way, using the directed or undirected graph. For better understanding we could imagine a postman who is walking the streets (in our case the graph) and wants to deliver the mail for each house (vertices on the given graph) in the shortest time possible and then return to the post office (starting point). The postman is trying to save time, effort and money by finishing his job using the shortest route. The traveling salesman problem is very similar to the Chinese postman problem at the first sight. It considers the case in which we want search for a walk using directed or undirected graph in the way to cross every vertex of the graph at least once using the shortest possible way. The salesman has to visit all the vertices in the way that he uses the shortest path (the sum of all connections used must be minimal) and return to the starting point. We can imagine that a salesman starts at point a . If the distances between every pair of points are known the question is; what is the shortest route the salesman could take to visit all the other points and return to point a ? Search for the minimum spanning tree considers the case in which we want components of unconnected graphs to be connected by using only some given edges. Search for the shortest path comes to use when we want to find the distance or the shortest way between two vertices in weighted graph. Finally we could state that the problems mentioned above show us the problems of the real world very nicely. The solutions of the problems of the graph theory are also very likely to show us the solutions of

*National conference on
Graph Theory And It's Applications (NCGTA-2018)
New Arts, Commerce And Science College, Parner
INDIA, 19-20, Jan. 2018 ISBN: 978-81-930155-0-9*

logistical problems in everyday life. For examples:

- The paths of the snowplows can be modeled with the help of the graph theory. For this purpose we usually use one of the variations of the Chinese postman problem.
- The construction of cable or electricity network, water supply lines etc. can be resolved with the search of minimum spanning tree.
- The routes and order of transporting goods from warehouses to shops can be modeled with the merchant problem.
- The planning of the phone cable network that is connecting several different objects is modeled with the search of minimum spanning tree.
- Searching for the shortest route is already one of the common problems in everyday life. The popular GPS technology is seen on many motor vehicles as a method of searching for the easiest way to determine the right path to the chosen point on the map.

Conclusion

The main objective of this article is to present the importance of graph theory in different branches of science and our everyday life . Here we have discussed only a few applications of graph theory. There are many application of graph theory in different branches like economics, logistics etc. Therefore graph theory has developed into a subject itself with variety of applications.

References

1. F.Harary, Graph Theory, Narosa Publishing House, (2013).
2. N.Deo, Graph Theory, Prentice Hall of India, Private Ltd, New Delhi, (2007).
3. S.G.Shrinivas, S.Vetrivel and N.M.Elango, Applications of graph theory in computer science an overview, International Journal of Engineering Science and Technology, 2(9)(2010), 4610-4621.
4. NarasinghDeo, Graph theory with applications to engineering and computer science, Prentice Hall of India, (1990).
5. J.A.Bondy, U.S.R.Murty, Graph theory with applications, The Macmillan Press Ltd., (1982).

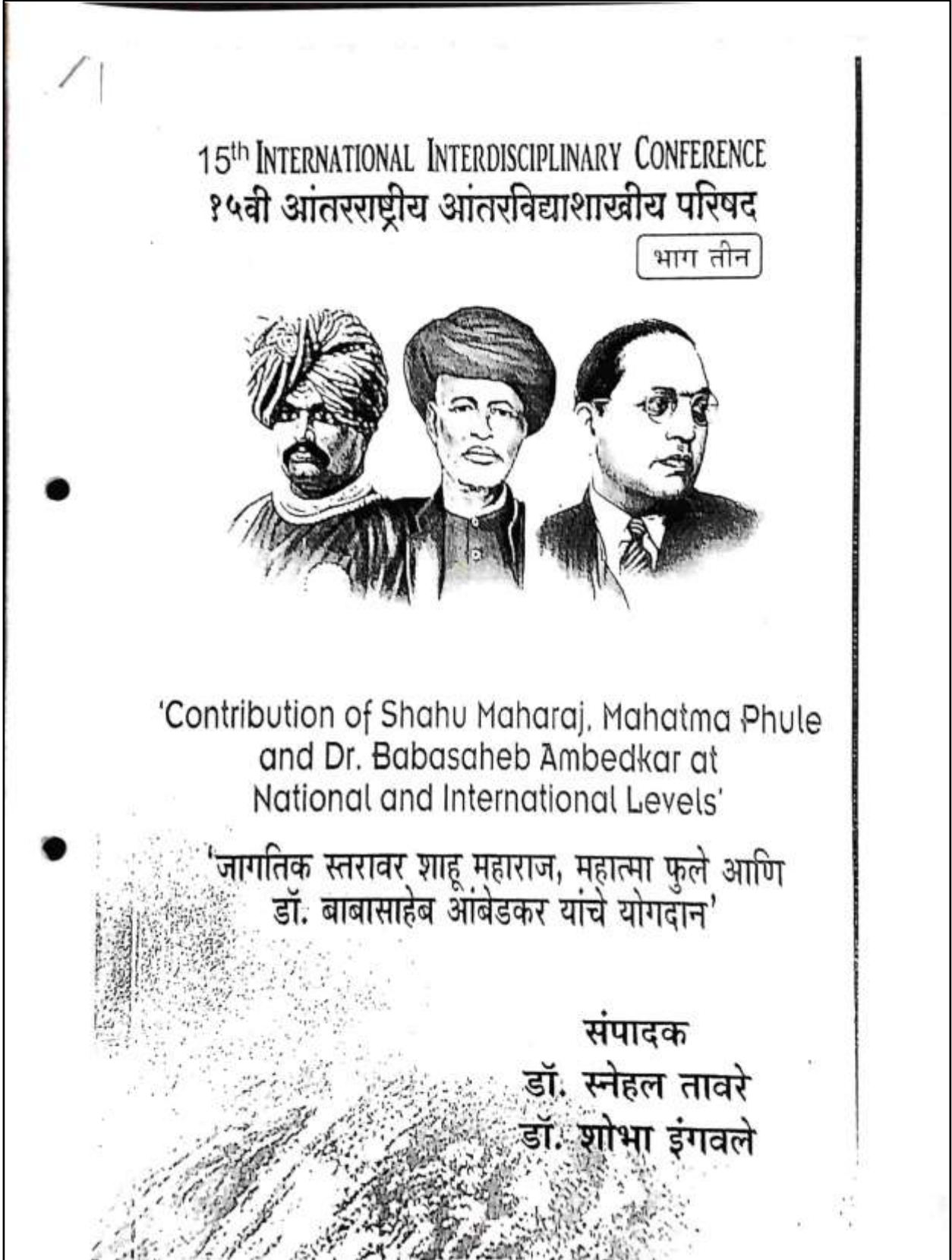
21. Dr. Babasaheb Ambedkar Yanche Shikshan Vishayak Vichar

- ❧ स्नेहवर्धन प्रकाशन : क्र. १२५०
- ❧ 'जागतिक स्तरावर शाहू महाराज, महात्मा फुले आणि डॉ. बाबासाहेब आंबेडकर यांचे योगदान' (भाग तीन)
(समीक्षा - संदर्भ)
- ❧ प्रकाशक आणि मुद्रक :
डॉ. एल. व्ही. तावरे
स्नेहवर्धन, ८६३ सदाशिव पेठ, महात्मा फुले सभागृहामागे,
पुणे - ४११०३०.
स्थिरभाष : (०२०) २४४७ २५ ४९ / २४४३६९६९
ई-मेल : snehaltawre@gmail.com
- ❧ © सर्व हक्क सुरक्षित
- ❧ प्रथमावृत्ती : ७ फेब्रुवारी २०१९
पंघरावी आंतरराष्ट्रीय आंतरविद्याशाखीय परिषद, पुणे
- ❧ मुखपृष्ठ : संतोष धोंगडे
- ❧ अक्षरजुळणी : एस. एस. ग्राफिक्स, पुणे
- ❧ मुद्रणस्थळ : स्मिता प्रिंटर्स, पुणे
- ❧ ISBN 978-93-87628-42-7
- ❧ पृष्ठसंख्या : २२८
- ❧ मूल्य : ₹ २५०/-
\$ 4

अनुक्रमणिका

संपादकीय -	डॉ. स्नेहल तावरे / ९ डॉ. शोभा इंगवले
१) सर्व क्षेत्रांत समानता तत्त्व आणि महिला अधिकारांचे समर्थक	डॉ. नीलम गोन्हे / ११ डॉ. बाबासाहेब आंबेडकर
२) युगपुरुषांचा पत्रव्यवहार - एक चिंतन	डॉ. माधवी खरात / १५
३) डॉ. बाबासाहेब आंबेडकर यांचे जलधोरण विषयक विचार	डॉ. मंजुश्री बोवडे / १९
४) डॉ. बाबासाहेब आंबेडकर : एक कला प्रेमी	डॉ. चंद्रकांत मंडलिक / २३
५) डॉ. बाबासाहेब आंबेडकरांचे ग्रंथलेखन-राष्ट्रीय-आंतरराष्ट्रीय-अनुबंध !	डॉ. मधुकर मोकाशी / २७
६) थोर समाजसुधारक, व्यासंगी अभ्यासक आणि शिक्षण प्रसारक : भारतरत्न डॉ. बाबासाहेब आंबेडकर	डॉ. चंद्रकांत रुद्राक्षे / ३१
७) जागतिक स्तरावर डॉ. बाबासाहेब आंबेडकर यांचे शैक्षणिक योगदान	डॉ. यशवंत गायकवाड / ३५
८) देशपातळीवरील पाणी प्रश्न आणि डॉ. बाबासाहेब आंबेडकर यांचे विचार आणि कार्य	डॉ. सूर्यकांत गित्ते / ३९
९) डॉ. बाबासाहेब आंबेडकर यांचे अर्थशास्त्रातील योगदान	डॉ. रमेश देसाई / ४३
१०) डॉ. बाबासाहेब आंबेडकर : शोषित वर्गाबाबतचे वैश्विक विचार	डॉ. सुभाष आहरे / ४७
११) सामाजिक समतेचे उध्वर्यु : डॉ. बाबासाहेब आंबेडकर	डॉ. नंदिनी रणखांबे / ५१
१२) डॉ. आंबेडकर यांचे पाकिस्तान विषयक धोरण	डॉ. संतोष कदम / ५५
१३) डॉ. बाबासाहेब आंबेडकर : स्त्री मुक्तीचे उद्गाते	डॉ. संजय गायकवाड / ५९
१४) डॉ. बाबासाहेब आंबेडकर यांचे अर्थशास्त्रविषयक विचार	डॉ. आर. एम. कोठारी / ६३
१५) डॉ. बाबासाहेब आंबेडकर यांचे शिक्षणविषयक विचार	डॉ. हरेश शेळके / ६६

डॉ. बाबासाहेब आंबेडकर यांचे शिक्षण विषयक विचार

डॉ. हरेश संपत शेळके

भ्रमणभाष : १७६७१७६६५१

शिक्षणविषयक विचार

“सामाजिक न्यायावर आधारित सम्यक परिवर्तन केवळ शिक्षणाने येऊ शकते. शिक्षण हेच सामाजिक क्रांतीचे साधन आहे.”

बरील अवतरणावरून लक्षात येते की, डॉ. आंबेडकरांनी अत्यंत तळमळीने, दूरदृष्टीचा विचार करून शिक्षणविषयक विचार प्रकट केले आहे. समाजात सामाजिक समता, न्याय, स्वातंत्र्य आणि ज्ञान या मानवी मूल्यांची पेरणी करायची असेल तर शिक्षण हा सर्वात चांगला मार्ग आहे. हा विचार तळागाळापर्यंत पोहचविण्यासाठी, त्यांच्यात महत्त्वाकांक्षा निर्माण करण्यासाठी डॉ. आंबेडकरांनी प्रचंड परिश्रम घेतलेले दिसून येतात. त्यांच्या शिक्षणविषयक विचारात जसा भविष्यकाळाचा वेध आहे तसेच प्राप्त परिस्थितीत शिक्षण घेऊन माणसाला आत्मविश्वासाने आणि आत्मसन्मानाने जीवन जगायला भाग पाडणारा दृष्टिकोनही आहे.

डॉ. आंबेडकर म्हणतात, “जगातील प्रत्येक समाजाचे भवितव्य त्या त्या समाजातील सुशिक्षित लोकांवर अवलंबून असते. आजपर्यंत तुमच्यात चळवळ झाली नाही याचे कारण तुमच्यात कोणी शिकलेले लोकच नव्हते. शिक्षणामुळे माणसाला डोळसपणा प्राप्त होतो.”

बरील विवेचनावरून लक्षात येईल की, डॉ. आंबेडकर शिक्षणाचा किती व्यापक परिघात विचार करतात. ते सुरुवातीलाच “जगातील प्रत्येक समाजाचे भवितव्य त्या त्या समाजातील सुशिक्षित लोकांवर अवलंबून असते.” असे म्हणतात. यावरून लक्षात येते की, प्रत्येक समाजाचा विकास होण्यासाठी, प्रत्येक समाजात परिवर्तन घडून येण्यासाठी सुशिक्षित जे लोक आहेत त्यांनी अधिक गांभीर्याने विचार करून, सर्वांना विश्वासात घेऊन, सामाजिक परिवर्तनासाठी प्रयत्नशील राहिले पाहिजे. डॉ. आंबेडकर अस्पृश्य समाजाला उद्देशून म्हणतात की, “तुमच्यामध्ये आजपर्यंत कोणी शिकले नाही त्यामुळे तुमच्यात चळवळ झाली नाही, तुमच्यात परिवर्तन होऊ शकले नाही. म्हणून शिक्षण हे फार महत्त्वाचे आहे कारण त्यातून व्यक्तीला, समाजाला डोळसपणा प्राप्त होतो, समाजातील प्रश्न, समस्या कशा सोडवायच्या याबद्दलचा दृष्टिकोन मिळतो, व्यक्तीचा समाजविषयक व जीवनविषयक दृष्टिकोन बदलतो. म्हणून शिक्षणाची शिदोरी सर्वांपर्यंत पोहचणे आवश्यक आहे”

जागतिक स्तरावर डॉ. बाबासाहेब आंबेडकर यांचे योगदान ४७ ६६

असे डॉ.आंबेडकर तळमळीने म्हणतात.

राजकीय चळवळी इतकेच शिक्षणप्रसाराला महत्त्व देताना डॉ.आंबेडकर म्हणतात, "आपण राजकीय चळवळीला जितके महत्त्व देतो तितकेच महत्त्व शिक्षण प्रसाराला दिले पाहिजे, कारण शिक्षणाशिवाय आपल्याला मान्याच्या जागा काबीज करता येणार नाहीत आणि जोपर्यंत मान्याच्या जागा आपण काबीज करीत नाही तोपर्यंत खरीखुरी सत्ता आपल्या हाती आली असे म्हणता येणार नाही."

वरील संदर्भावरून लक्षात येते की, डॉ. आंबेडकर एकूणच अस्पृश्य समाजाला व शिक्षणापासून वंचित राहिलेल्या समूहाला उद्देशून म्हणतात की, "राजकीय चळवळ करून आपण जे स्वातंत्र्य मिळवणार आहोत, संघटित होणार आहोत, आपल्या मागण्यांचा पाठपुरावा करणार आहोत, आपल्या अस्तित्वासाठी झगडणार आहोत. इतके महत्त्व आपण आपल्या एकूण जीवनमानात राजकीय चळवळीला दिलेले आहे हे जसे महत्त्वाचे आहे तितकेच महत्त्वाचे म्हणजे आपण शिक्षणाच्या प्रसारालाही महत्त्व दिले पाहिजे. कारण आपण जर शिकलो तर आपल्याला मान्याच्या जागा काबीज करता येतील म्हणजेच जेणेकरून समाजात अस्पृश्य समजल्या गेलेल्या व समाजाने दुर्लक्षित ठेवलेल्या घटकांना शिक्षणामुळे आपल्या अस्तित्वाची ओळख होईल, त्यांच्यात आत्मविश्वास येईल आणि या सर्व गोष्टींमुळे जर ते महत्त्वाच्या पदावर पोहचले तर इतरांसाठी त्यांना खूप मोठे कार्य करता येईल जेणेकरून आपल्या मागे राहिलेल्या वर्गाला पुढे आणण्यासाठी, त्यांना दिशा दाखविण्यासाठी त्यांना आपल्या अस्तित्वाची ओळख करून देण्यासाठी. तसेच अस्पृश्य व इतर दुर्लक्षित घटकांना मुख्य प्रवाहापर्यंत आणण्यासाठी महत्त्वाच्या पदापर्यंत पोहचणे आपल्याला अपरिहार्य आहे." असा विचार डॉ.आंबेडकर खूप तळमळीने व्यक्त करताना दिसतात.

राजकीय सत्ता मिळविण्यासाठी आपल्याजवळ विद्या पाहिजे कारण विद्या नसेल तर राजकीय सत्तेच्या दोऱ्या आपल्या हातात येण्यास उशीर होईल. या विचाराचे महत्त्व स्पष्ट करताना डॉ.आंबेडकर म्हणतात, "शिक्षण व विद्या या गोष्टींशिवाय आपला उद्धार होणार नाही." ते पुढे म्हणतात, "जिच्या हाती पाळण्याची दोरी तीच..." असे काही म्हटले जाते. त्याचप्रमाणे "राजकारणाच्या दोऱ्या विद्येशिवाय आपल्या हाती येणार नाहीत."

वरील संदर्भावरून लक्षात येईल की, डॉ.आंबेडकर अस्पृश्य समाजाला केवळ विद्येचे आणि शिक्षणाचे महत्त्व सांगून थांबत नाहीत तर आपल्या उज्वळ भवितव्यासाठी, सामाजिक उन्नतीसाठी विद्या आणि शिक्षण हे अत्यंत आवश्यक आहे. असा विचार ते तळमळीने रूजवताना दिसतात. तसेच ते हेही स्पष्ट करतात की, "जिच्या हाती पाळण्याची दोरी..." ती जगाला उद्दारी तसेच जोपर्यंत राजकारणाच्या दोऱ्या आपल्या हातात येणार नाहीत तोपर्यंत आपला उद्धार होणार नाही. म्हणूनच डॉ. आंबेडकर विद्या आणि शिक्षण या घटकांवर अधिक भर देतात. कारण विद्येमुळे, ज्ञानामुळे आपल्याला उच्च प्रतीच्या मानाच्या जागा मिळवता

डॉ. बाबासाहेब आंबेडकर यांचे शिक्षण विषयक विचार ४० ६७

येतील आणि आपल्या विकासाची वाट अधिक सोपी करता येईल. डॉ.आंबेडकर शिक्षणाचे महत्त्व पटवून देताना म्हणतात, "हिंदू समाजाच्या अगदी खालच्या थरातून आल्यामुळे शिक्षणाचे किती महत्त्व आहे हे मी जाणतो. खालच्या समाजाची उन्नती करण्याचा प्रश्न आर्थिक असल्याचे मानण्यात येते. पण ही मोठी चूक आहे. हिंदुस्थानातील दलित समाजाची उन्नती करणे म्हणजे त्यांच्या अन्न, वस्त्र व निवाऱ्याची सोय करून पूर्वीप्रमाणेच त्यांना उच्च वर्गाची सेवा करावयास लावणे नव्हे. खालच्या वर्गाची ज्याच्यामुळे प्रगती खुंटून त्यांना दुसऱ्याचे गुलाम व्हावे लागते, तो न्यूनगंड त्यांच्यातून नाहिसा करणे, चालू समाजपद्धतीमुळे जे त्यांचे जीवन निर्दयपणे लुबाडण्यात आले आहे त्याचे त्यांच्या स्वतःच्या आणि राष्ट्राच्या दृष्टीने काय महत्त्व आहे याची त्यांना जाणीव करून देणे हाच खालच्या वर्गाचा प्रश्न आहे. उच्च शिक्षणाच्या प्रसाराखेरीज कशानेच हे साध्य होणार नाही. आमच्या सर्व दुखण्यावर माझ्या मताप्रमाणे हेच औषध आहे."^{१८}

बरील विवेचनावरून लक्षात येते की, डॉ. आंबेडकर शिक्षणाचा किती व्यापक परिघावरून विचार करतात. कारण शिक्षण घेत असतानाच त्यांनी अस्पृश्य म्हणून दुय्यमपणे मिळणाऱ्या सर्व वागणुकीच्या वेदना सहन केल्या होत्या. म्हणूनच डॉ. आंबेडकर म्हणतात, अस्पृश्य समाजातील मूलभूत प्रश्न सोडवायचे असतील तर शिक्षण हेच महत्त्वाचे आहे. कारण अस्पृश्य समाजाच्या उन्नतीचा प्रश्न हा आर्थिकतेशी निगडीत नसून तो उच्च शिक्षणाशी जास्त निगडीत आहे असे ते म्हणतात.

डॉ.आंबेडकरांचा हा विचार आजही तितकाच महत्त्वाचा आहे. कारण आजही वंचित समाजातील, दुर्बल घटकांतील विद्यार्थ्यांपर्यंत चांगले शिक्षण पोहचण्यासाठी त्यांना त्यांचे भवितव्य घडविण्यासाठी जर बसतिगृहांची उभारणी करण्यात आली तर विद्यार्थी आपले उज्ज्वल भवितव्य घडवू शकतात.

राजकीय स्वातंत्र्य जितके आवश्यक आहे तितकेच शिक्षणही महत्त्वाचे आहे या विषयाचे महत्त्व स्पष्ट करताना डॉ.आंबेडकर म्हणतात, "केवळ राजकीय प्रगतीने जीवनातील सर्व प्रश्न सुटत नाहीत. जीवनाच्या प्रगतीकरिता ज्या अनेक गोष्टींची गरज आहे, त्यापैकी राजकीय स्वातंत्र्य ही एक होय. शिक्षण हीच खऱ्या अर्थाने जीवनाच्या प्रगतीकरिता महत्त्वाची बाब होय. गेल्या २५ वर्षांपासून मी राजकारणात काम करीत आहे. पण माझ्या इतक्या दिवसांच्या अनुभवावरून मला असे वाटते, की शिक्षण हीच जीवनातल सर्वात महत्त्वाची बाब आहे."^{१९}

बरील विवेचनावरून लक्षात येईल की, डॉ.आंबेडकर शिक्षणावर अधिक भर देतात कारण अस्पृश्य समाजाला आपल्या अस्तित्वाची ओळख लवकर होणे आवश्यक होते, समाजात त्यांना सन्मानाची वागणूक मिळणेही आवश्यक होते. हे सर्व शिक्षणामुळेच घडून येणार होते यामुळे डॉ. आंबेडकर शिक्षण हा व्यक्तीच्या विकासातल अत्यंत महत्त्वाचा पैलू मानतात. कारण शिक्षणामुळेच मनुष्य विचार करायला लागतो, शिक्षणामुळे त्याची प्रगती होण्यास सुरुवात होते. तो समाज जागतिक स्तरावर डॉ. बाबासाहेब आंबेडकर यांचे योगदान ४० ६८

वाचवायला शिकतो, आपल्यावर होणाऱ्या अन्यायाची त्याला जाणीव व्हायला लागते. त्याचा जीवनविषयक दृष्टिकोन बदलण्यास मदत होते. इत्यादी सर्व गोष्टीत शिक्षणामुळे व्यक्तीच्या जीवनात परिवर्तन घडून येण्यास मदत होते. वर्षानुवर्षे ज्या अस्पृश्य समाजाला शिक्षणापासून वंचित रहावे लागले आहे. त्यामुळेच त्यांच्यावर अशा पध्दतीने जगण्याची वेळ आली आहे त्यांच्या जीवनात परिवर्तन घडवून आणावयाचे असेल तर शिक्षणाशिवाय पर्यायच नाही याचा डॉ. आंबेडकरांनी अतिशय गांभीर्याने विचार केला होता कारण राजकीय स्वातंत्र्याने सामाजिक जीवनात बदल जरूर घडतील परंतु व्यक्तीच्या विकासासाठी, त्याचा दृष्टिकोन बदलण्यासाठी, त्याला आपल्या अस्तित्वाची ओळख व्हावी यासाठी शिक्षण हे खूपच आवश्यक आहे. म्हणूनच जीवनाच्या प्रगतीकरिता शिक्षण ही अतिशय महत्त्वाची बाब आहे असे डॉ. आंबेडकर स्पष्ट करतात.

अशा प्रकारे डॉ. बाबासाहेब आंबेडकरांचे शिक्षणविषयक विचार आपल्याला समजून घेता येतील.

संदर्भ सूची -

- १) लुलेकर प्रल्हाद, 'अनंत पैलूंचा सामाजिक योद्धा', दलितेतरांसाठी डॉ.बाबासाहेब आंबेडकर, सायन पब्लिकेशन, पुणे, प्रथमावृत्ती २०११, पृ.क्र.१५२.
- २) तत्रैव पृ.क्र.७५
- ३) जाधव नरेंद्र, (अनु.व संपा), 'बोल महामानवाचे', डॉ.बाबासाहेब आंबेडकर यांची ५०० मर्मभेदी भाषणे, खंड-३, ग्रंथाली प्रकाशन, मुंबई, पहिली डिलक्स आवृत्ती २४ ऑक्टो २०१२, पहिली जनआवृत्ती २४ ऑक्टो.२०१२, पृ.क्र.४२०
- ४) तत्रैव पृ.क्र.४२०
- ५) जाधव नरेंद्र, (अनु.व संपा), 'बोल महामानवाचे', डॉ.बाबासाहेब आंबेडकर यांची ५०० मर्मभेदी भाषणे, खंड-२, ग्रंथाली प्रकाशन, मुंबई, पहिली डिलक्स आवृत्ती २४ ऑक्टो २०१२, पहिली जनआवृत्ती २४ ऑक्टो.२०१२, पृ.क्र.२१३
- ६) तत्रैव पृ.क्र.२१८
- ७) तत्रैव पृ.क्र.२१८
- ८) तत्रैव पृ.क्र.२१८
- ९) तत्रैव पृ.क्र.२२७
- १०) तत्रैव पृ.क्र.१९६, १९७
- ११) तत्रैव पृ.क्र.१९७
- १२) तत्रैव पृ.क्र.२२०

४०४०

डॉ. बाबासाहेब आंबेडकर यांचे शिक्षण विषयक विचार ४० ६९

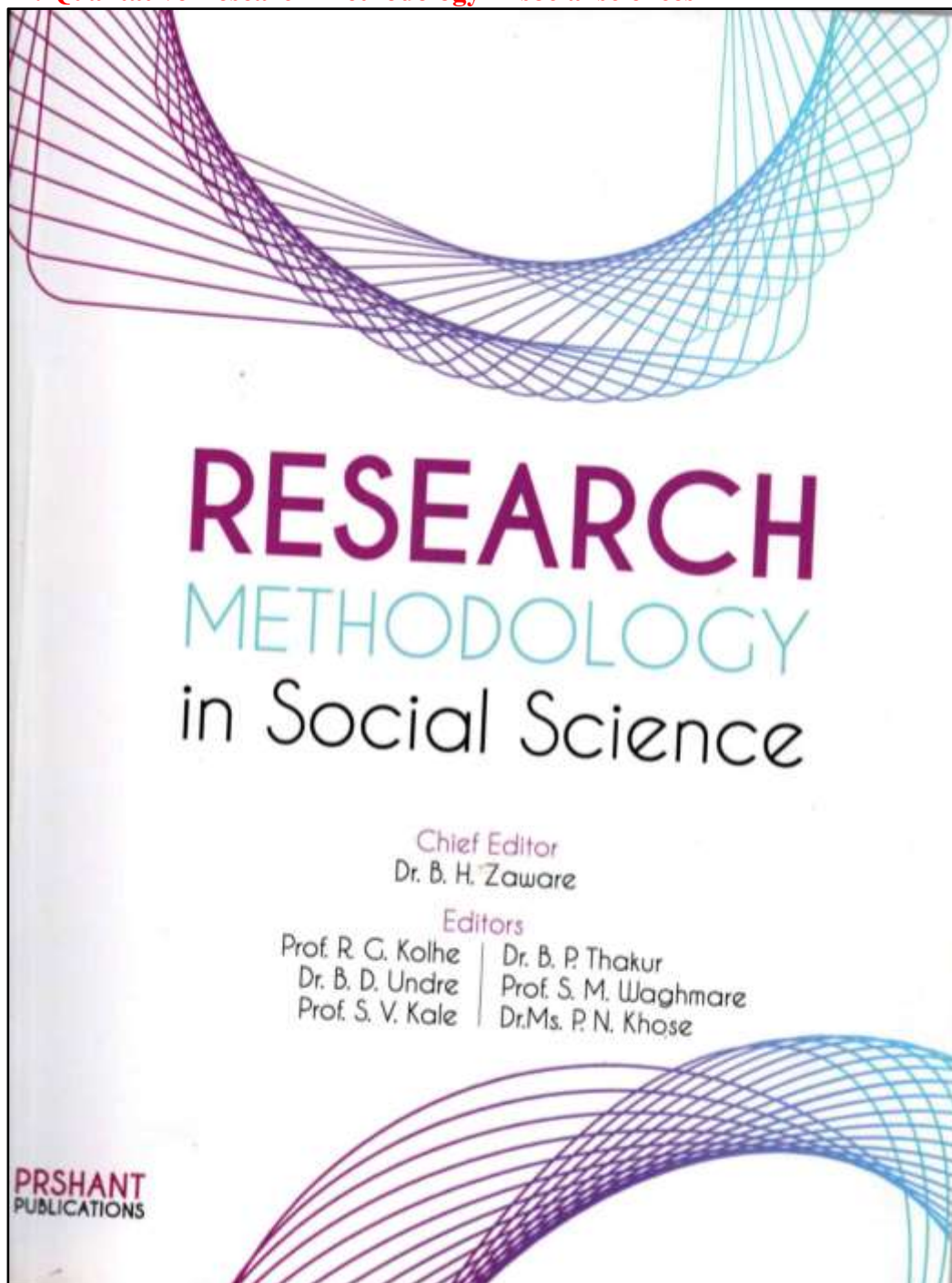
22. Qualitative Research Methodology in social sciences

35. Importance of Tabulation in Research Methodology.....	123
- Waghmare Santosh Marutirao	
36. Research And Social Science	126
- Gadadare Ananda Baban	
37. Challenges of Social Sciences Research.....	128
- Dr. Undre Baliram Dadarao	
38. Scope of Social Science Research.....	131
- Nanwate N. N.	
39. Qualitative Research Methodology in Social Sciences.....	134
- Dr. Sontakke Deepak P., Dr. Ghorpade Ashok V.	
40. Ethics in Historical Research	138
- Satbhai Ravi S.	
41. संशोधनातील आराखड्याचे महत्त्व	140
- डॉ. तोडकर बी. डी.	
42. अर्थशास्त्रीय संशोधन व संशोधन आराखडा	146
- कुंडगीर बी. आर.	
43. सामाजिक संशोधन : संकल्पना, स्वरूप व प्रकार	149
- इंगोले तक्षशिला आनंदराव	
44. इतिहास संशोधन स्वरूप आणि कार्य पध्दती	151
- शिरसाठ संदिप हरीभाऊ	
45. समाजशास्त्रीय संशोधनात गुणात्मक संशोधनाचे महत्त्व.....	157
- गावित हरिदास जकू	
46. सामाजिक संशोधन आणि समाज शास्त्र एक दृष्टीक्षेप	161
- पाऊलबुध्दे अनुराधा रामभाऊ, डॉ. कोरडे अशोक	
47. इतिहास लेखातील प्रायोगिक संशोधनाच्या भूमिकेचे परीक्षण	164
- पाटोळे रूपाली अशोक	
48. सामाजिक शाखांतील संशोधनाचे महत्त्व.....	167
- डॉ. भागानगरे एस. डी.	
49. सामाजिक संशोधनातील वस्तूनिष्ठतेचे महत्त्व	171
- डॉ. भिंगारदिवे सुरेखा	
50. संशोधन आणि सामाजिक विज्ञान.....	174
- डॉ. चौधरी मोहन किसनराव	
51. सामाजिक शास्त्रातील संशोधनातील मुल्यात्मक निर्णय व मूल्यनिरपेक्षता	177
- डॉ. बगाडे अमन	
52. समकालीन इतिहासातील संशोधनाची उपयुक्तता	179
- शितोळे रमेश अंबराजी	

Qualitative Research Methodology in Social Sciences

Dr. Sontakke Deepak P., Dr. Ghorpade Ashok V.
New Arts, Commerce and Science College, Parner.

Introduction:

Qualitative research is a type of social science research that collects and works with non-numerical data and that seeks to interpret meaning from these data that help us understand social life through the study of targeted populations or places. People often frame it in opposition to quantitative research, which uses numerical data to identify large-scale trends and employs operations to determine causal and correlative relationships between variables.

Within sociology, qualitative research is typically focused on the micro-level of social interaction that composes everyday life, whereas quantitative research typically focuses on macro-level trends and phenomena.

Methods of qualitative research include observation and immersion, interviews, open-ended surveys, focus groups, content analysis of visual and textual materials, and oral history.

Objective of the Study:

This study analyses the qualitative research methodology for the new researchers. We have tried to highlight aspects of qualitative research strategy in social sciences and related subjects. This study will bear the following specific objectives:

- To provide a basic understanding of qualitative research.
- To equip with sufficient information to appreciate how qualitative research is undertaken.
- To highlight different types of qualitative research.

Methods of Qualitative Research:

Qualitative researchers use their own eyes, ears, and intelligence to collect in-depth perceptions and descriptions of targeted populations, places, and events. Their findings are collected through a variety of methods, and often, a researcher will use at least two or several of the following while conducting a qualitative study.

- **Direct observation:** With direct observation, a researcher studies people as they go about their daily lives without participating or interfering. This type of research is often unknown to those under study, and as such, must be conducted in public settings where people do not have a reasonable expectation of privacy. For example, a researcher might observe the ways in which strangers interact in public as they gather to watch a street performer.
- **Open-ended surveys:** While many surveys are designed to generate quantitative data, many are also designed with open-ended questions that allow for the generation and analysis of qualitative data. For example, a survey might be used to investigate not just which political

candidates voters chose, but why they chose them, in their own words.

- **Focus group:** In a focus group, a researcher engages a small group of participants in a conversation designed to generate data relevant to the research question. Focus groups can contain anywhere from 5 to 15 participants. Social scientists often use them in studies that examine an event or trend that occurs within a specific community. They are common in market research too.
- **In-depth interviews:** Researchers conduct in-depth interviews by speaking with participants in a one-on-one setting. Sometimes a researcher approaches the interview with a predetermined list of questions or topics for discussion but allows the conversation to evolve based on how the participant responds. Other times, the researcher has identified certain topics of interest but does not have a formal guide for the conversation, but allows the participant to guide it.
- **Oral history:** The oral history method is used to create a historical account of an event, group, or community, and typically involves a series of in-depth interviews conducted with one or multiple participants over an extended period of time.
- **Participant observation:** This method is similar to observation, however with this one, the researcher also participates in the action or events in order to not only observe others but to gain the first-hand experience in the setting.
- **Ethnographic observation:** Ethnographic observation is the most intensive and in-depth observational method. Originating in anthropology, with this method, a researcher fully immerses herself into the research setting and lives among the participants as one of them for anywhere from months to years. By doing this, the researcher attempts to experience day-to-day existence from the viewpoints of those studied in order to develop in-depth and long-term accounts of the community, events, or trends under observation.

Analysis of Qualitative Data :

Data analysis is actually a dynamic process weaving together recognition of emerging themes, identification of key ideas or units of meaning and material acquired from the literature. An intensive data analysis only starts when all data have been collected and prepared. Sometimes the process begins before all the data are collected. Each transcript is read thoroughly in its entirety. The aim at this stage is to use the data to think with, and one looks to see whether any interesting patterns can be identified [Hammersley & Atkinson,

Advantages of Qualitative Research:

The advantages of performing qualitative research are as follows .

- It is flexible to follow unexpected ideas during research and explore processes effectively.
- It raises the sensitivity to contextual factors.
- A researcher has a clear vision on what to expect.
- Issues and subjects covered can be evaluated in depth and in detail.
- Smaller sample sizes are used, which save costs.
- Here subject materials can be evaluated with some greater details.
- Complexities and subtleties about the subjects of the research can be avoided in many positivistic inquiries.

RESEARCH METHODOLOGY IN SOCIAL SCIENCE | 135

23. Phase changes under heat treatment during synthesis of Alpha-Al₂O₃ by Sol Gel method

International Conference on Materials and Environmental Science (ICMES-2018)

A-124

Electron Irradiated Polyaniline Thin Films: Promising Material for High-Performance Electrochemical Supercapacitor Electrode

U.M. Chougale¹, M. C. Rath², V. J. Fulari^{1*}

¹Holography and Materials Research Laboratory,

Department of Physics, Shivaji University, Kolhapur-416 004, Maharashtra, India

²Radiation and Photochemistry Division, BARC, Mumbai-400 085

E-mail: vijayfulari@gmail.com

Abstract:

Herein, Polyaniline (PANI) thin films were prepared by easy, economical and environmentally benign electrochemical polymerization with optimized parameters. These films were irradiated with 10 MeV electron beam (EB) at the different radiation doses viz. 10, 30 and 50 kGy. The effect of irradiation on structure and morphology of PANI was analyzed by XRD, FTIR, SEM and contact angle measurement. The electron irradiation modifies structure and morphology of PANI thin films by chain scission and cross-linking processes. Due to irradiation, an increase in crystallinity and increase in average size of fibers has been observed. The electrochemical properties of the irradiated PANI electrodes were studied with cyclic voltammetry, galvanostatic, and electrochemical impedance spectroscopy techniques in the suitable electrolyte. It has been found that an increase in irradiation dose decreases the specific capacitance of PANI electrodes but 14% enhancement in stability determined by long-term cycling performance after irradiation. Subsequently, EIS analysis reveals a decrease in electrode resistance after electron irradiation. Enhanced electrochemical stability with decreased electrode resistance of electron-irradiated PANI films put forward its suitability as supercapacitor electrodes for electrochemical energy storage application.

Keywords: Supercapacitors; polyaniline; electrodeposition; electron irradiation.

A-126

Phase Changes Under Heat Treatment During Synthesis of α -Al₂O₃ Nanoparticles By Sol-Gel Method

Vijaya Pandurang Dhawale¹, Satish Damodar Kulkarni²

¹Post Graduate Department of Physics, New Arts Commerce and Science College, Parner, Ahmednagar, India

²Post Graduate Department of Environmental Science, New Arts Commerce and Science College, Ahmednagar, India

Email: vijaya.dhawale2009@gmail.com

Abstract:

In the present study, α -Al₂O₃ nanoparticles were synthesized using alcoholic solution of AlCl₃, 25% NH₃ and Polyvinyl alcohol (PVA). PVA act as a capping agent. All these chemicals were inexpensive raw materials. Stable crystalline phase of α -Al₂O₃ nanoparticles occurred at a temperature 1100°C. During heat treatment, stable α -Al₂O₃ can be obtained through the series of phase transformations from boehmite, γ , δ , θ to α - phase of Al₂O₃. Crystalline nanoparticle formation of the dried sol was investigated using x-ray diffractometry (XRD). XRD shows crystal size increases from 25 nm to 32 nm when calcination temperatures increases from 500°C to 1100°C. It was shown that crystal size increases during the heat treatment. Morphology of α -Al₂O₃ nanoparticles was studied using Scanning Electron Microscopy (SEM), along with energy-dispersive X-ray analysis (EDAX). TGA and DTA shows, 77% weight loss and phase transformations. Synthesized α -Al₂O₃ nanoparticles were applied in waste water treatment as an adsorbent.

Key words: Sol-gel method, Phase change, Heat treatment, Calcination.

24. Phototoxicity of nanoparticles on plant growth

C. T. Bora College, Shirur, EMAN-2019

Phytotoxicity of Nanoparticles

V.P. Dhawale¹, K.C. Mohite², S. D.Kulkarni³

¹Post Graduate Department of Physics, New Arts Commerce and Science College, Parner, Ahmednagar, India

²Post Graduate Department of Physics, C.T. Bora College, Shirur, Pune, India

³Post Graduate Department of Environmental Science, New Arts Commerce and Science College, Ahmednagar, India

Email address: vijaya.dhawale2009@gmail.com

ABSTRACT

Phytotoxicity study was an important tool to understand environmental impacts of nanoparticles on plants. In present study, effect of nanoparticles aluminium oxide, silver and nanocomposites of aluminium oxide and silver were studied on *Vigna radiata* (Vr) and *Vigna aconitifolia* (Va) plants. Study was carried out with the help of parameters %germination, biomass, root length, shoot height and dry weights of the plants. Three concentrations of nanoparticles were taken 50,100, 150 mg/L for the analysis. Study reveals that, %germination was not affected by nanoparticles in both type of plants. In *Vigna radiata* (Vr), biomass and dry weights were higher than biomass of control plants whereas slightly higher biomass and almost same dry weights as that of control plants of *Vigna aconitifolia* (Va) except slightly less biomass was found in silver nanoparticles and nanocomposites of aluminium and silver in *Vigna aconitifolia* (Va). Root length was highest in nanocomposite than control whereas shoot height of control was maximum in *Vigna radiata* (Vr). In case of *Vigna aconitifolia* (Va) root length and shoot height was comparable and slightly higher than control plant. The dosage of nanoparticles (50-150 mg/L) were used in relevance of the study of degradation of crystal violet, malachite green and methylene blue dye using aluminium oxide, silver nanoparticles and aluminium-silver nanocomposite. Overall study revealed that, waste water containing smaller dosage of nanoparticles was not toxic to the plants.

Key words: Phytotoxicity, biomass, root length, shoot height, nanoparticles.

25. Synthesis and Characterization of Bismuth Ferrite by Sol gel method

The image shows the cover of an abstract book. At the top left is a circular portrait of a man in a cap and glasses. To the right of the portrait, the text reads: "Pune District Education Association's Baburaoji Gholap College Sangvi, Pune - 411027, Maharashtra, India Affiliated to Savitribai Phule Pune University, Pune NAAC B+ grade (Reaccredited)". To the right of this text is the PDEA logo. The central text reads: "ABSTRACT BOOK for International Conference on Sustainable Materials for Advanced Research in Technology SMART-2019 February 5th-6th, 2019". Below this is a large, stylized graphic of a microscope with blue molecular models. Below the graphic, it says "Sponsored by" followed by the Savitribai Phule Pune University logo and name: "Savitribai Phule Pune University Ganeshkind, Pune 411 007". At the bottom, there is a blue banner with the text "SMART-2019" in large, stylized letters. Below the banner are images of various materials: colorful layered structures, a dark car-like object, a hand holding a curved strip, and a blue starburst pattern.

Pune District Education Association's
Baburaoji Gholap College
Sangvi, Pune - 411027, Maharashtra, India
Affiliated to Savitribai Phule Pune University, Pune
NAAC B+ grade (Reaccredited)

ABSTRACT BOOK
for
International Conference on
Sustainable Materials for Advanced Research in Technology
SMART-2019
February 5th-6th, 2019

Sponsored by

Savitribai Phule Pune University
Ganeshkind, Pune 411 007.

SMART-2019



This improves the efficiency of the conventional Otsu's thresholding method. The proposed method of segmentation utilizes gray level thresholding for segmentation and then morphological operators and thresholding are used for extracting the optic disk and blood vessel. The method is tested on the different optical disc images. The method is less complex and efficiently recognizes the boundary of the optic disc and also evaluates the blood vessel. The optical centers are tabulated for original and fundus images.

Keywords: Diabetic retinopathy (DR); Non-proliferative diabetes retinopathy (NPDR); Microaneurysm; hemorrhage; Optic disk.

*Corresponding author: Tel.: +91 020 26994404 (Office), +91 9029075387 (Mobile).
E-mail: shar_chaudhari@yahoo.co.in, jyot.physics@gmail.com

PP – 19

Synthesis and characterization of bismuth ferrite by sol gel method

S. L. Kadam

Post Graduate Department of Physics, New Arts, Commerce and Science College, Parner, Dist.
Ahmednagar -414 302, Maharashtra, India.

Abstract

Bismuth ferrite (BiFeO_3) multiferroic nanoparticles synthesized by sol gel method using bismuth nitrate and iron nitrate as starting materials and citric acid as chelating agent, respectively followed by thermal treatment annealed at 300°C , 400°C and 500°C . It is found that BiFeO_3 nanoparticles crystallized at annealed 300°C . BiFeO_3 nanoparticles with different size distributions show obvious ferromagnetic properties and the magnetization are increased with reducing the particle size. The prepared samples were characterized by X-ray diffraction of powder (XRD), scanning electron microscope (SEM) or extracting their surface morphology and their crystallographic structure and revealed a homogenous size distribution of nanometric Bismuth Ferrite perovskite powders with a grain size of 200 nm which is in well agreement.

Keywords: Bismuth ferrite; Nanoparticles; X-ray diffraction; SEM.

*Corresponding author: E-mail: mr.sukadeo@rediffmail.com

26. Synthesis and Characterization of silica nanoparticles via stober's method

Innovation in physical, Chemical and Life Sciences (IPCLS-2018)

ISBN: 978-81-926129-6-6

Synthesis and characterization of silica nanoparticles via stober's method

S. L. Kadam

*Post Graduate Department of Physics, New Arts, Commerce and Science College, Parner,
Dist. Ahmednagar-414 302, SPPU, Pune (Maharashtra), INDIA.*

E-mail: mr.sukadeo@rediffmail.com

Abstract

More attention has been focused on silica nanoparticles by scientific community due to its advanced applications in various fields. The optical properties of silica nanoparticles can be attained with respect to surface defect related to large surface/volume ratio according to the applications. In this paper, silica nanoparticles were synthesized by using tetraethylorthosilicate (TEOS \geq 99% GC) (Sigma Aldrich), ammonia solution (NH₄OH) 30% (S D fine-chem. Limited) and absolute ethanol (Changshu Yanqun, China). All chemical were analytical grade. This is well known Stober's Method. The infrared spectra of silica nanoparticles of various sizes are similar. TEM measurements has also confirmed that the particles are monodisperse, spherical in nature and having a size of around 130 nm. The SAED pattern shows that the particles are amorphous in nature. The compositional ratio of silicon and oxygen is analyzed by EDX and found that the particles are composed only of Si and Oxygen. The nanoparticles are monodisperse and amorphous in nature.

Keywords: Silica Nanoparticles, Stober Method, FTIR, Amorphous.

New Arts, Commerce and Science College, Parner, Dist. A'Nagar, M.S, INDIA



27. Effect of Sintering On Zn- Mn Ferrite

AJMVPS Centenary Year ISBN: 978-81-926129-6-6

7th International conference
on
**'Innovations in Physical, Chemical and
Life Sciences'**
(IPCLS-2018)
December, 27-28th, 2018

Organized by
Post Graduate Department of Physics
&
Internal Quality Assurance Cell
New Arts, Commerce & Science College, Parner.
Dist. Ahmednagar
Pin- 414302 (Maharashtra), India.

Journal of Research in Physical, Chemical and Life Sciences (JPCLS-2018)

ISBN: 978-81-926129-6-6

Effect of Sintering on Zn-Mn ferrite

S. L. Kadam

*Post Graduate Department of Physics, New Arts, Commerce and Science College, Parner,
Dist. Ahmednagar-414 302, SPPU, Pune (Maharashtra), INDIA.*

E-mail: mr.sukadeo@rediffmail.com

Abstract

Nanocrystalline ZnMnFeO₄ ferrite was prepared by using sol-gel autocombustion method. The sample was sintered at different temperatures in air. The structural and magnetic properties were studied by X-ray diffraction, scanning electron microscopy, and FTIR techniques. X-ray diffraction data reveals that the manganese substituted Zinc ferrites are cubic at temperature 973K and tetragonal at higher sintering temperature. The shape and size of ferrites were obtained from the scanning electron microscopy technique. FTIR study of ferrite was also carried out. The magnetic studies indicated that, the ferrimagnetic behavior increases with sintering temperature.

Keywords: Ferrites, X-ray diffraction, FTIR, Magnetic studies

Department of Physics, New Arts, Commerce and Science College, Parner, Dist. A'Nagar, M.S, INDIA



28. A Comparison of Classification Methods: Naïve Bayes and Support Vector Machine

A COMPARISON OF CLASSIFICATION METHODS: NAÏVE BAYES AND SUPPORT VECTOR MACHINE

Pankaj Patil*, Mohd. Abdul Raffey¹, W.K. Sarwade², Sunil Kawale³

* Corresponding Author, Dept. of management science, Dr. Babasaheb Ambedkar Marathwada University, Aurangabad.

¹ Assistant Director, HRDC, Dr. Babasaheb Ambedkar Marathwada University, Aurangabad.

² Director, Dept. of management science, Dr. Babasaheb Ambedkar Marathwada University, Aurangabad.

³ Head, Dept. of Statistics, Dr. Babasaheb Ambedkar Marathwada University, Aurangabad.

Abstract: Nowadays the most popular classification technique Naïve Bayes and Support Vector Machine (SVM) used in machine learning and Natural Language Processing fields to predicting the feature about sales as well as other areas. This paper shows the best method among them by comparing them. The paper focuses on comparing the classifier for the accuracy of classification depends on data set size and n-gram methods. Product reviews are taken from Twitter to carry out the experiments.

Keywords: Naïve Bayes, Support Vector Machine, NLP, PCA, Bags of words.

1. Introduction

Support Vector Machine introduced in 1992 and was initially used for handwritten digit recognition. SVM worked based on Kernel method. It is a supervised machine learning algorithm which is used in regression and classification challenges but mostly used in classification problems. Support Vector Machines depend on the idea of decision planes that define decision limits. A decision plane is one that isolates between arrangements of items having distinctive class participation.

Naïve Bayes is the classification techniques based on Bayes theorem in which assumption is made that independence among predictors. More simply the Naïve Bayes assumes that there is no relation of the presence of the particular feature in a class with the presence of any other feature.

In the present paper we have taken twitter reviews of products with its special features. Bloggers are frequently tweeting good and bad about the product they have purchased. Many time new buyer goes through these reviews and decide to purchase or not, but the problem is that of which method of review classification is better to trust. Many researchers have said Naïve Bayes is the best method of classification. To check this we compared Naïve Bayes with Support Vector Machine which is commonly used to the classification of data.

2. Review of Literature

Liangxiao Jiang (2007) reviewed some of these improved algorithms and single out four main improved approaches like Feature selection, Structure extension, Local learning, and Data expansion. The author tested these approaches using the whole 36 UCI data sets selected by Weka and compared them to Naïve Bayes. The results show that all these approaches are effective.

M. Govindarajan (2013) proposed a new hybrid classification method on Sentiment Analysis of Movie Reviews based on coupling classification methods using arcing classifier and their performances are analyzed in terms of accuracy. The experiment resulted in the lead

to the observations. i.e. Genetic Algorithm (GA) exhibits better performance than Naïve Bayes (NB) in the important respects of accuracy and comparison between the individual classifier and the hybrid classifier: it is clear that the hybrid classifier shows the significant improvement over the single classifiers.

Gautami Tripathi et.al. (2015) proposes a model for sentiment analysis of movie reviews using a combination of natural language processing and machine learning approaches. They have applied different data pre-processing schemes on the dataset, the behavior of two classifiers, Naïve Bayes and SVM, is investigated in combination with different feature selection schemes to obtain the results for sentiment analysis. The proposed model for sentiment analysis is extended to obtain the results for higher order n-grams. The classification results clearly show that Linear SVM gives more accuracy than Naïve Bayes classifier. Although many other previous works have also identified SVM as a better method.

Wamukekhe Everlyne Nasambu et.al. (2014) identifies ways of improving the prediction of product sales in mobile phones. Consequently, the study will realize a predictive model that will classify sentiments from social media and compute the probability and present an improved predictive model.

G. Vinodhini et.al. (2013) evaluate the effect of a feature reduction method with both Support Vector Machine and Naïve Bayes classifiers. For feature reduction method used is principal component analysis. The experiments are conducted using two classifiers, SVM and NB, on the product review data set. It is proved that the use of PCA as a feature reduction method is more accurate than Naïve Bayes and SVM as a classifier.

Nazeeh Ghatasheh (2014) evaluates the performance of various Machine learning algorithms for credit risk prediction and also many experiments from observation and literature are included in this paper. Finally, Author concludes with Random Forest Tree is overperformed among most other models i.e. Support Vector Machine, Artificial Neural Network, Genetic Programming, and Fuzzy Immune Learning also this model is having various advantages for business experts like competitive classification accuracy and simplicity because of such advantages the decision makers easily understand all the relation.

Vijay Katkar et. al. (2015) presents a novel method of sales forecasting using fuzzy logic, data warehouse, and Naïve Bayesian classifier. Experiments are performed using sales data of five years collected from many shops located in different cities to prove the efficiency of the proposed mechanism.

K Netti (2017) applied Naïve Bayes Classifier on earthquake data which is available as RSS feed also called as GeoRSS data. It can be mapped onto any GIS software for determining the area of interest. However, if the data is dense identifying a particular area of interest could be very cumbersome. The author proposes an efficient model using Naïve Bayes Classifier to predict the outcome in GeoRSS data. In this paper author proved that applying Naïve Bayes Classifier on a data set like GeoRSS, gave better accuracy for identifying an exact location of the earthquake with specific magnitude.

Vidhya.K.A (2010) surveyed the various feature selection methods has been discussed and compared along with the metrics related to text document classification. From the survey the inference made is that the Naïve Bayes technique performs better and yields higher classification accuracy when combined with the other techniques.

3. Review processing and comparison with the proposed model

To compare the support vector machine and naïve bias we have taken Twitter user those who have given the review for products. There are many product review tweets are available social networking site out of these we have extracted 237300 records per data set.

The following figure is the outline of the proposed model.

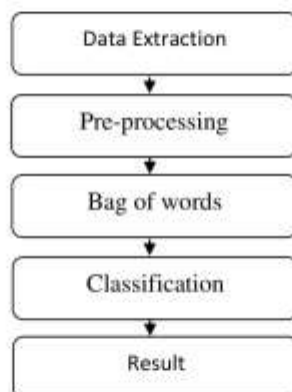

Figure 1. Proposed Model

a. Data Extraction

In this step, data is collected from the most famous microblogger site i.e. "Twitter". The numbers of tweets are too large so it is not possible to select the tweets manually; hence python language is used with "Tweepy.api" as an interface to extract tweets directly from Twitter. To extracting such tweets we need to generate the necessary credential i.e. for example, access_token, access_token_secret, consumer_key & consumer_key_secret, for establishing the connection from the authorized Twitter account. The extracted data is captured to a text file in the format of JSON (JavaScript Object Notation) because it is human-readable format as well as machine also easily parses it. By this step 237300 tweets have taken through Simple Random Sampling without replacement Technique.

b. Pre-processing of dataset

The pre-processing step is involved transferring raw data extracted with the machine to the human understandable format while extraction the data often comes with some unwanted symbols and links so to remove them and resolving such issue the data pre-processing is the important step it prepares the raw data for future processing. It always used in database driven like customer relationship management system and rule-based application like Neutral Network. The extracted data need to go through the series steps of pre-processing like Data Cleaning, Data Integration, Data Transformation, Data Reduction, and Data Discretization. These steps are used to clean the raw data contain Escaping HTML characters, Decoding data from "utf8" to "ASCII", Apostrophe Look up, Stop words

removal, Punctuation removing, Expression removing, Standardizing the word, URL/link removing.

c. Bags of words

Those n-gram strategies likewise an arrangement of written words of length is used to build bags of words. It is a methodology that split the sentence to small words also assembly them by combining of n-grams. This stage might have been processed as follows:

- After the pre-processing stage, we got the review data, on that we applied Bags of words dependent upon the chosen n-gram (unigrams, bigrams, trigrams) model. Because the classifier does not understand the meaning of complete sentence we split the sentence into the words.

- N-gram models use simple word segmentation, apostrophes, parts of speech, phrases and so on to include specific properties.

- The words which are imported for specific build hashing term-frequency vectorizer that checks those frequencies and set the numeric value for next stage i.e. classification stage also set the weight required for each word. It means a term frequency will check the importance of the word from the extracted review.

- The feature vector converts the words in unique value which is in the integer format i.e. Number and frequency is assigning to the word.

d. Classification

In this stage, the data set was gone through the Naïve Bayes and SVM classifiers. And check the classification accuracy of data with the help of following accuracy formula.

$$\text{Accuracy} = \frac{\sum_{i=1}^l \frac{tp_i + tn_i}{tp_i + fn_i + fp_i + tn_i}}{l} \times 100\%$$

Where, l is number of class, tp_i is true positive classification, tn_i true negative classification, fp_i is false positive classification, fn_i is false negative classification.

e. Results

As per the formula, we have checked the classification accuracy for 5 different datasets with both the technique and the result are as follows:

y

	Naïve Bayes	Support Vector Machine
Data Set 1	44.01	42.99
Data Set 2	34.82	34.06
Data Set 3	24.66	22.84
Data Set 4	44.78	43.70
Data Set 5	45.22	44.06

Table1: Accuracy

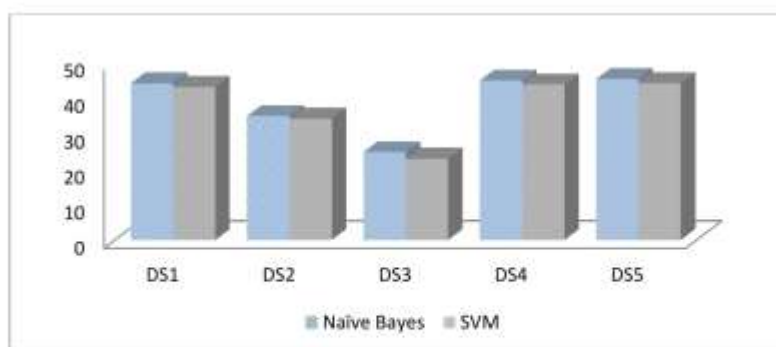

Figure 2: Graphical representation of accuracies

4. Conclusion

The most popular classifiers Naïve Bayes and Support Vector Machine are compared. The findings show that the Naïve Bayes multiclass classification method for Twitter product reviews achieved more classification accuracy (Minimum 24.66 % – Maximum 45.22%) as the comparison of Support Vector Machine. (Minimum 22.84% – Maximum 44.06%). The experimental result indicates that the classification method Naïve Bayes has more accuracy than SVM.

Finally, we conclude with the statement that the Naïve Bayes classifier is the best classifier than other one.

5. References

Vijay Katkar, Surupendu Prakash Gangopadhyay, Sagar Rathod, Aakash Shetty (2015) "Sales forecasting using data warehouse and Naïve Bayesian classifier" in 2015 International Conference on Pervasive Computing (ICPC) IEEE pp 1-6

Wamukekhe Everlyne Nasambu, Waweru Mwangi, Michael Kimwele (2014) "Predicting Sales In E-commerce Using Bayesian Network Model" in IJCSI International Journal of Computer Science Issues, Volume 11, Issue 6, No 2, pp 144-152

K Netti* and Y Radhika (2017) "A Model for Accurate Prediction in GeoRSS Data Using Naïve Bayes Classifier" in Journal of Scientific & Industrial Research Vol. 76, August 2017, pp. 473-476

Vidhya.K.A, G.Aghila (2010) "A Survey of Naïve Bayes Machine Learning approach in Text Document Classification" in (IJCSIS) International Journal of Computer Science and Information Security, Vol. 7, No. 2, 2010

Liangxiao Jiang, Dianhong Wang, Zhihua Cai, Xuesong Yan (2007) "Survey of Improving Naïve Bayes for Classification" in International Conference on Advanced Data Mining and Applications ADMA 2007: Advanced Data Mining and Applications pp 134-145

<http://dataaspirant.com/2017/02/06/Naïve-bayes-classifier-machine-learning/>

<https://medium.com/hugo-ferreiras-blog/basics-of-machine-learning-and-a-simple-implementation-of-the-naïve-bayes-algorithm-80c1e67a2e8a>

<https://monkeylearn.com/blog/practical-explanation-naïve-bayes-classifier/>

<https://www.proschoolonline.com/blog/predictive-analytics-meaning-important-algorithms-learn/>

<https://medium.com/cracking-the-data-science-interview/a-tour-of-the-top-10-algorithms-for-machine-learning-newbies-7228aa8ef541>

<https://www.logianalytics.com/bi-trends/what-is-predictive-analytics/>

<https://www.kdnuggets.com/2015/05/top-10-data-mining-algorithms-explained.html/3>

https://dreamtolearn.com/ryan/1001_datasets

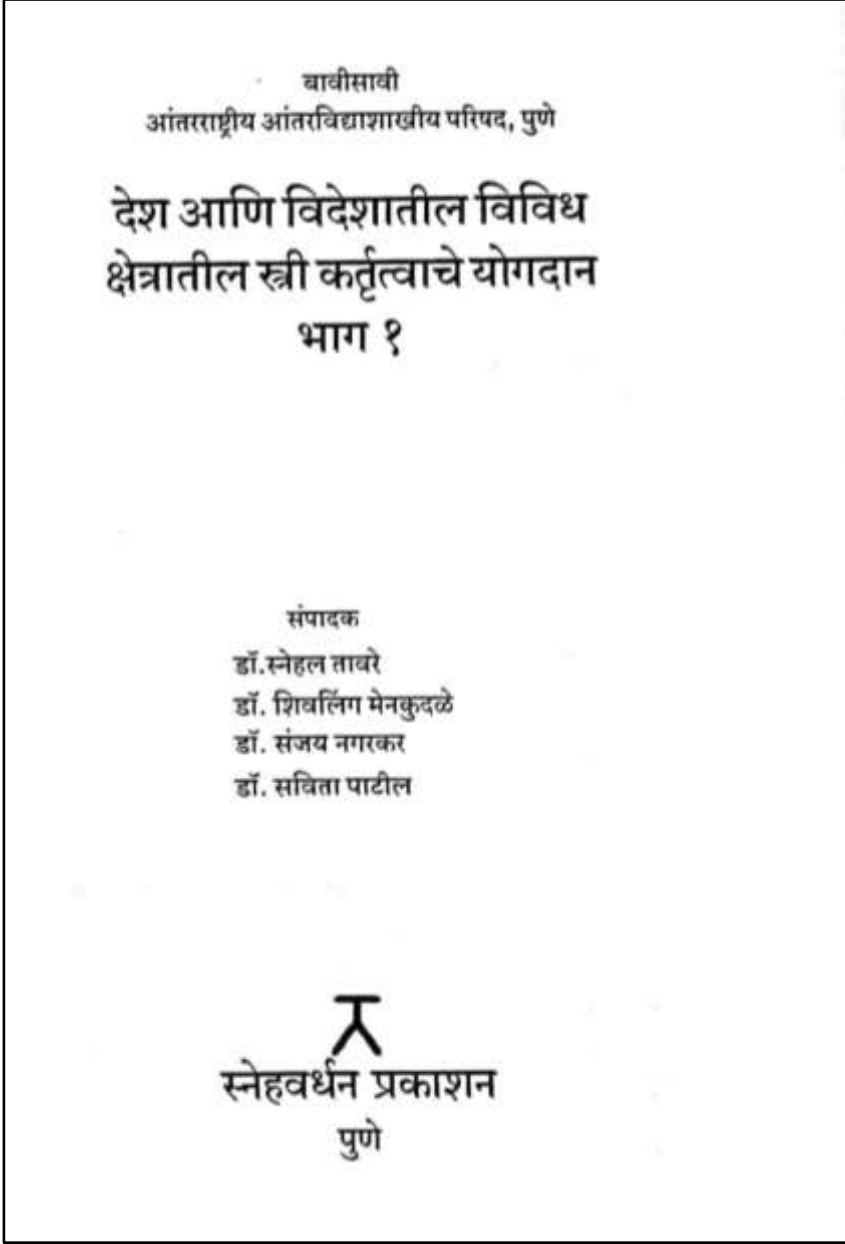
29. Ramabai Ambedkar yanche Dr. Babasahebanchya Kutumbatil Yogdan

❖ स्नेहवर्धन प्रकाशन : क्र. १२१०
 ❖ देग आणि विदेशातील विविध क्षेत्रातील स्त्री कर्तृत्वाचे योगदान
 भाग - १
 (समीक्षा - संस्मृती)
 ❖ प्रकाशक आणि मुखद्रुक
 डॉ. एल.एच. तावरे
 स्नेहवर्धन, ८६३ महागाव पेठ,
 महानगर पुणे सभागृहमन्ये, पुणे ४११ ०३०
 विभागाचे: (०२०) २४४७ २५ ४९ / २४४ ३६ ९११
 प्रमसंवाप : ९४२३६४२१३१/९०५५०८९८८८
 ईमेल : snehatawre@gmail.com
 ❖ मुखपृष्ठ : संतोष घोगडे
 ❖ © S.R. I.
 ❖ प्रथमावृत्ती : १५ डिसेंबर २०१९
 २२ वीं आंतरराष्ट्रीय अंतरविद्याशास्त्रीय परिषद, पुणे
 ❖ अक्षरसुश्रूषी : सुनील फालेकर, पुणे
 ❖ सुद्धमस्थळ : मित्रा डिस्ट्रिग प्रेस, पुणे
 ❖ ISBN 978-93-87628-75-5
 ❖ पृष्ठसंख्या : १८८
 ❖ मूल्य : ₹ २५०
 ₹ 3

विद्याची मूलाधार असलेल्या,
 कोणत्याही परिस्थितीला खंबीरपणे
 तोंड देणाऱ्या, अह्रावधानी असलेल्या
 समस्त स्त्री शाक्तीला
 आदरपूर्वक सन्नेह अर्पण...
 - डॉ. स्नेहल तावरे
 - डॉ. शिवलिंग मेनकुदळे
 - डॉ. संजय नगरकर
 - डॉ. सविता पाटील

y

११. सिंदू लेडी : फर्स्ट प्रिन्टिशन - डॉ. संजय नगरकर ..५१	२५. रमाबाई अंबेडकर यांचे - डॉ. होम जीवक ..१००
इस डॉक्टर : डॉ. रश्मिकाई सावे-राऊत	डॉ. सत्यसादेबाबा कुटुंबातील योगदान
१२. आर्येनु व्यक्तियोजना - डॉ. स्नेहल तावरे ..५५	२६. इंग्रजीची रानी लक्ष्मीबाई - डॉ. सचिंद्र बागुंजकर..११०
डॉ. लीला गोविंदकर	यांचे एरुम वय
१३. इंग्लंडमधील सावित्रीबाई पुते - डॉ. पांडुरंग पाचकवाडे ..५९	२७. इंदिरा गांधी : सत्यनवारी - डॉ. सुनील कवडे ..११४
कार्य आणि कर्तृत्व	राजसज्जनाच्या ज्ञान
१४. अहिराबाई होळकर यांचे - डॉ. सोमनाथ पट्टम ..६३	२८. अंबेदाकर बर्मल: बदलत्या - डॉ. सुधीर वाडेकर ..११८
सामाजिकवादातील योगदान	राजकीय परिस्थितीच्या अंधधुई
१५. सत्यन सरोवर : - डॉ. सुजटा लोडे ..६७	२९. भारताच्या विकासाला इंदिरा - डॉ. योगेश विठ्ठल ..१२२
एक प्रेरणादायी व्यक्तिमत्त्व	यांची योगदान
१६. राहु उभारपीतीत इंदिरा गांधी - डॉ. रघुनाथ रवदिने ..७१	३०. भारतीय जनता पार्टी - डॉ. आनंद शिंदे ..१२५
यांचे योगदान	श्रीराम यांचे भारतीय शिक्षणातील योगदान
१७. सावित्रीबाई पुते यांचे ऐतिहासिक - डॉ. सुनील परदेशी ..७५	३१. संगीताचा अखंड झरा : - डॉ. राजेश बागळे ..१२९
आणि सामाजिक कार्य	एक संशोधन
१८. भारतमाये जीवन आणि - डॉ. सुप्रिया पवार ..७९	३२. सावित्रीबाई पुते - पतिव्रत व कार्य - डॉ. सारंगी लालका ..१३३
ऐतिहासिक विचार	३३. एकोनिसाव्या शतकातील विचारांचे - डॉ. कांचन नारायण ..१३७
१९. इंग्लंडमधील सावित्रीबाई पुते - डॉ. भारती पाटव ..८३	सामाजिक आणि ऐतिहासिक कार्य
यांचे सामाजिक कार्यातील योगदान	३४. पंडित लक्ष्मीबाई यांचे - डॉ. विठ्ठल कंधारी ..१४१
२०. 'साई... यांचेची साहसी'...तिपुबाई सत्यनराव - डॉ. शिरीस पाचवडे ..८७	सामाजिक कार्य
अस्मिताची साहसी	३५. इंग्लंडमधील सावित्रीबाई पुते - डॉ. रामचंद्र पवार ..१४५
२१. सावित्रीबाई पुते यांचे ऐतिहासिक - डॉ. सुजटा निंबाळकर ..९१	यांचे ऐतिहासिक कार्य
आणि सामाजिक योगदान	३६. श्रीराम सुर्वीच्या अद्ययनेचा : - डॉ. पृथ्वी पाडवते ..१४९
२२. डॉ. विद्या बेटी यांचे - डॉ. योगेश जीवक ..९५	सावित्रीबाई पुते
व्यक्तिगत कर्तृत्व	३७. इंग्लंडमधील सावित्रीबाई - डॉ. प्रमती पाचवडे ..१५३
२३. सावित्रीबाई पुते यांचे योगदान - डॉ. अतुल चोरी ..९९	उन्नीसव्या पुते
२४. प्रतिभाबाई पटील : - डॉ. शरती नारायण ..१०३	३८. पंडित लक्ष्मीबाई यांचे सामाजिक - डॉ. शिरीसबाई पाटव ..१५७
भारताच्या पोलिसा संहिता राहणारी	विचार आणि कार्य

रमाबाई आंबेडकर यांचे डॉ. बाबासाहेबांच्या कुटुंबातील योगदान

- डॉ. हरीश शेलके

डॉ. बाबासाहेब आंबेडकर हे एक प्रतिभावंत विद्यार्थी होते. सामाजिक आणि आर्थिक अडथळांवर मात करून महाविद्यालयीन पदवी मिळवणाऱ्या दलिताना पहिल्या पिढीतील ते एक होते. त्यांनी कोलंबिया विद्यापीठ आणि लंडन स्कूल ऑफ इकॉनॉमिक्स या दोन्हीतून अर्थशास्त्रातील डॉक्टरेट पदव्या मिळवल्या आणि कायदा अर्थशास्त्र आणि राज्यशास्त्रातील संशोधनासाठी एक विद्वान म्हणून प्रतिष्ठित झाले. आपल्या सुरुवातीच्या कारकिर्दीत ते अर्थशास्त्र प्राध्यापक आणि वकील होते. त्यांनी नंतरच्या जीवनात राजकीय कार्यावर लक्ष केंद्रित केले. ते भारताच्या स्वातंत्र्यासाठी प्रचार व चर्चांमध्ये सामील झाले, भारताच्या स्वातंत्र्यासाठी वृत्तपत्रे प्रकाशित करणे, दलितानांसाठी राजकीय हक्क व सामाजिक स्वातंत्र्याचा त्यांनी पुरस्कार केला आणि भारताच्या स्थापनेसाठी महत्त्वपूर्ण योगदान दिले. अशा डॉ. बाबासाहेब आंबेडकरांच्या जीवनात रमाबाई आंबेडकर यांचे योगदान अतिशय महत्त्वाचे राहिलेले आहे.

रमाबाई आंबेडकर यांनी बाबासाहेबांना दिलेली साथ, वेळोवेळी बाबासाहेबांना धीर देण्यासाठी केलेले प्रयत्न, बाबासाहेबांवर आलेल्या प्रतिकूल परिस्थितींमध्ये त्यांच्या पाठीशी खंबीरपणे उभे राहून त्यांना दिलेला मानसिक आधार, बाबासाहेबांच्या आरोग्याची पेटलेली अतिशय बाराकांढी दखल, कुटुंबातील आर्थिक व्यवहार, नातेवाईकांशी असणारा सलोखा या सर्व आघाट्यांवर रमाबाईंनी अतिशय सक्षमपणे नेतृत्व केले. एका बाजूला डॉ. आंबेडकर देशाची घडी बसवत होते तर दुसऱ्या बाजूला रमाबाई आंबेडकर कुटुंबाची घडी बसवत होत्या. रमाबाई आंबेडकरांनी बाबासाहेबांना उच्चशिक्षणासाठी समाजाची सेवा करण्यासाठी त्यांना संसाराच्या जाळ्यात अडकवून ठेवत नाही. त्यांच्यासाठी कष्ट सोसले, रोग आणणे, जळण्यासाठी गोबऱ्या घापणे, गोबऱ्या विकून त्या पैशांवर संसाराचा गाढा हाकणे इत्यादी तप केले आहे आणि म्हणूनच त्यांना बाबासाहेबांसारखा ज्यांच्या विद्वतेची कीर्ती

रमाबाई आंबेडकर यांचे डॉ. बाबासाहेबांच्या कुटुंबातील योगदान ८४ १०३

जागृत पसाली आहे असा थोर असा थोर दुष्ट विनमरणाचा नकार मिळाला आहे त्यांच्या बरोबर तपस्वतेचे हे फल आहे.

एकदा डॉ. अंबेडकरांना दुर्मिळ ग्रंथ स्वस्तात घेऊन, त्या ग्रंथाचा पहिला भाग बरोबर घेऊन ते परी रात्री जेवण्यासाठी गेले अर्धे वाचण्यासाठी बसले. रमाबाईंनी चाच घडून देवले व त्या सांभोर बसल्या. जेवायला सुध्दात कात घडून त्यांनी चाच सात वेळा पोटिया सांगिले. ते त्रासितकरणाने म्हणाले, "काच हो तुम्ही काचकात ! अर्धे, असले चाच ग्रंथ मी पाचवे स्थळात घेतलेले आहेत हे पान संख्ये दे मला मग मी जेवतो." त्यावर रमाबाई म्हणाल्या, "अन्वयाने चाचकोकडे, मुलाकडे, संसाराकडे लक्ष द्यावे, असे त्या पानावर लिहिले आहे का तेकडे सांगायला, मग जेवा !" साहेबांनी स्मित करून जेवायला सुध्दात केली व ते म्हणाले, "मी संसाराकडे लक्ष देत नाही, असे नेहमी माझ्या माजाने छडे फोडोस, काय काणवे मी ?" त्यावर रमाबाई म्हणाल्या, "अहो पणत भाजीपात, तेल, मीठ लागते तिचकडे असा नजयाने लक्ष द्यावे, मूलाबाळांच्या अंबाकन गौडकन जवळ घेऊन बसावे, चाचकोशी चार चाच खोसावेत. घेऊन जाऊन तुमची ती पुस्तके अन् तुम्ही ! पुस्तकांसाठी पाचवे स्थाने एकदम छर्च करणाची काय जशी होती? तुम्हाला शोध्या विखांनी मूल शोणार आहे कवी तर शुद्ध देवाकवी होती." रमाबाई शोध्यांत अन् अल्प विधुन येत्या. साहेब दुसऱ्या रात्री परी आले ते हळत भाजीच्या पाच-सत पैड्या, बीबीलाच्या १००- १२५ काड्या घेऊन ! तेव्हा त्यांच्या हस्तातील बाजार पाहून संस्मीबाई हन् लागल्या. त्या म्हणाल्या, "अहो भाऊजी ! या भाजीच्या पैड्या उद्या पला सुकून जातील आणि सगळी भाजी आम्हा आज काही संख्ये पाकणार नाही." आगछी जलत बोलतो तर पट म्हणता ब्रह्महत्या न्यायची असे समजून त्यांनी सर्व बाजार स्वयंपाक घालत नेले. रमाबाई स्वयंपाक करीत होत्या त्या दोघी आज मलापासून हन् लागल्या.

दोन-तीन दिवसांनी या गौडीचा साहेबांनी अर्धितानाच्ये गणसंख्यी बसलेल्या लोकानांच्ये उद्देख केला. तेव्हा लोक हन् लागले. साहेबांनी हन् लागले. ते म्हणाले, "मी हा असा ! बायको व भावजय आहेत म्हणून माझे घर चालते आहे." संस्मीबाई का चीम करीच्या असताना विधवा झाल्या. अजला सुलत मुकुटा घालत घेऊन त्या कुटुंबात उदित्या. त्या रमाबाईंच्या घडील बाऊबाई अन्वुही त्यांच्यासाठी का अर्थीने मागत. रमाबाईंची प्रकृती नेहमीच शोड्यापासा. तेव्हा लक्ष्मीबाईंचा सगळा बोडा पडे. रमाबाई त्यांना का अर्थीने, सधेने व प्रेक्ष्यपणाचे काणवीत. या दोन पवित्र जीवांच्या प्रेक्ष्यपणाच्या अनेक आठवणी साहेब लोकांना सांगत, "या दोघी कधीच भांडत नाहीत, हे त्यांचे वैशिश्य आहे." असे साहेब वारंवार उद्या काढीत असत आणि ते रोघी हन् म्हणत बायकोशी, मुलांशी बसे सांगते हे काही अल्पन्वरात सुद्धत नाही. आजलं

हेतू आणि विवेकातील विविध घेरातील श्री बंधूंच्याने योगदान ४४ १०८

पुस्तकांनी छान सुद्धत.

असा पदवीने डॉ. बाबासाहेब अंबेडकरांच्या कुटुंबात रमाबाईंनी दिलेले योगदान हे आपला सर्वांचा विचकार स्वयंघात राहिल असेच आहे. एकदा महापुरुषांच्या जडशयडणीत कुटुंबातील पावतीने दिलेली साध ही त्या महापुरुषांच्या उर्ध्व भारी इतकीच महत्त्वपूर्ण असले. कदाचित त्यामुळेच त्या महापुरुषाला आपले काय करणासाठी समाजापध्ये प्रशंस जालत येते. असा अनेक वीरांगणा या महापुरुषात होऊन गेल्या त्यातील रमाबाई अंबेडकरांच्या कुटुंबात, त्यांच्या कायरीत, त्यांनी डॉ. बाबासाहेबांच्या कुटुंबात दिलेल्या योगदानाला आजही सलाम करावा लागेल.

४४४

संदर्भ ग्रंथ :

१. अंबेडकर बाबासाहेब 'माझी जाणबधा' मधुची पब्लिकेशन, नरिमन, पुढ इत्यांक १५८, १५९.
२. छैप्योडे चांगदेव भवानराज, डॉ. भीमराज रामजी अंबेडकर, छंद योन, कालाखंड १९२० ते १९३०, मुगावा प्रकाशन, इचवामुली १४ एडिल १९५८ पुढे क्र. १०८, १०९.

रमाबाई अंबेडकरांचे डॉ. बाबासाहेबांच्या कुटुंबातील योगदान ४४ १०९

30. Prachin Va Madhyayugin Newase

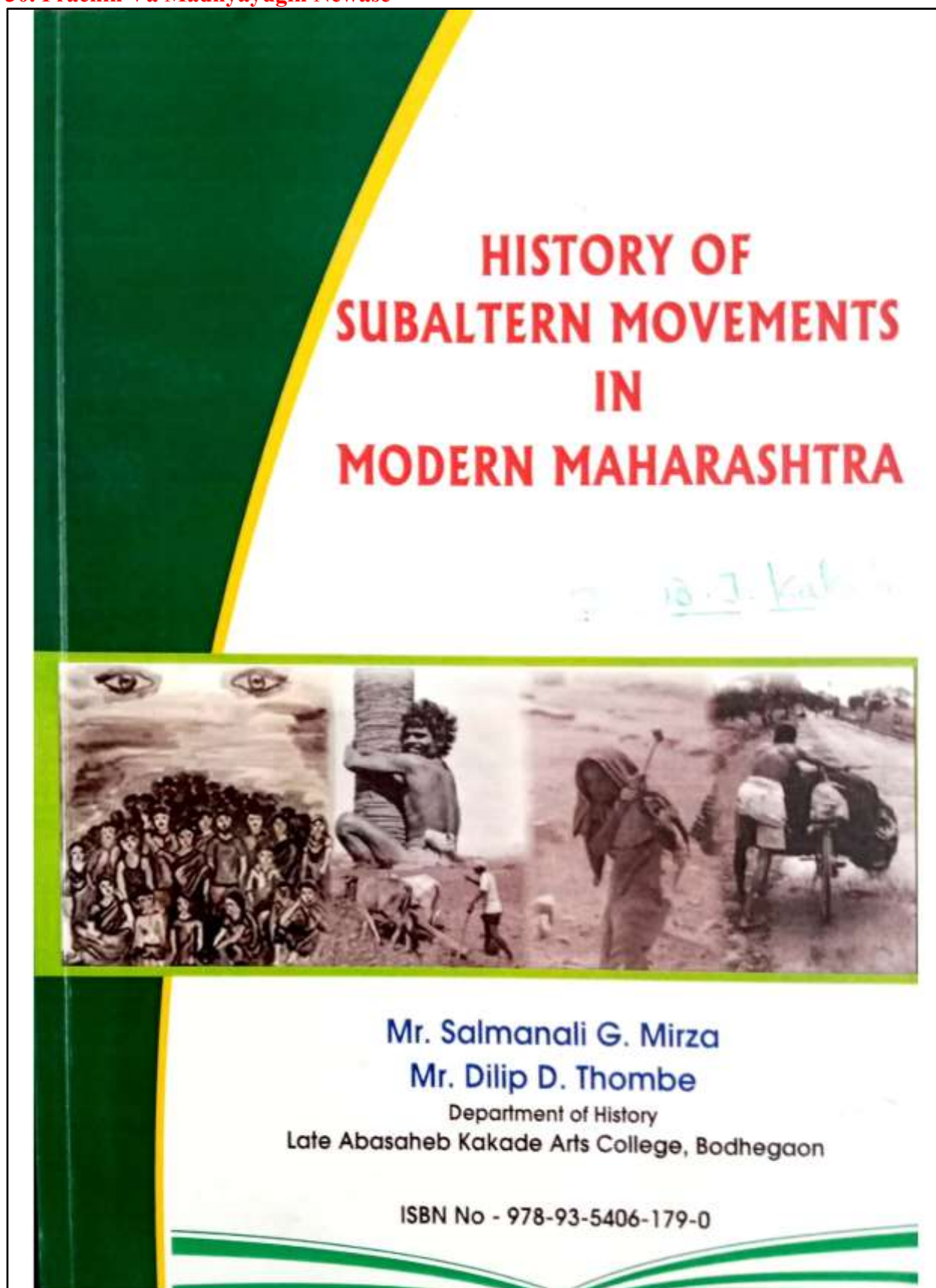

- अनुक्रमणिका -

अ.क्र.	विषयाचे नाव	लेखकाचे नाव	पृष्ठ क्रमांक
१.	महाराष्ट्रातील १९ व्या शतकातील शेतकरी	डॉ. कैलास भागलकर	०१ ते ०५
२.	आदिवासी क्रांतीकारक राधाजी भांगरे	डॉ. अशोक कामडे	०६ ते ०९
३.	महर्षी विठ्ठल शिंदे : शेतकऱ्यांचे कैवरी	डॉ. मुनीब शेख	१० ते १३
४.	स्वातंत्र्यपूर्व काळातील भारतातील शेतकरी चळवळ	प्रा. वाय.एच. पंढरकर	१३ ते १९
५.	डॉ.बाबासाहेब आंबेडकरपुर्व दलित चळवळीतील गोपाळबाबा बलंगकर यांचे योगदान	प्रा. वाय.पी. शिंदे	२० ते २४
६.	स्वातंत्र्योत्तर मराठवाड्यातील शेतकरी चळवळ	डॉ. उदय राजल	२५ ते २८
७.	बीचतांची चळवळ	डॉ. अशोक दान	२९ ते ३१
८.	स्त्रीवादो चळवळीची वाटचाल - एक अभ्यास	डॉ. रिगंबर सोनवणे	३२ ते ३७
९.	बीजमाता राहीबाई पोपरे	डॉ. राजाराम सोनवणे	३८ ते ४१
१०.	अपंगत्वाचा प्रश्न : ऐतिहासिक तथ्ये व सद्यस्थिती	डॉ. विजय फडम	४२ ते ४८
११.	महाराष्ट्रातील शेतकरी चळवळीचा इतिहास	डॉ. विजय राजदेव प्रा. संघन दाम	४९ ते ५५
१२.	इतिहासातील बीचत आदिवासी क्रांतीकारक	प्रा. लक्ष्मी काकडे	५६ ते ६६
१३.	डॉ. बाबासाहेब आंबेडकरांचे दलित चळवळीतील योगदान	श्रीमती करिष्मा फलकर	६७ ते ७१
१४.	स्त्रीवादो साहित्याची भारतात भूमिका : एक तात्विक विश्लेषण	प्रा. मनाज पाटील	७२ ते ७६
१५.	प्राचीन, मध्ययुगीन कालखंडातील स्त्रीजीवन आणि स्त्री मुक्ती चळवळीचा झालेला उदय	प्रा. एस.एम. हाणे प्रा. स्नेहलता विटसे	७७ ते ८०
१६.	स्वातंत्र्योत्तर महाराष्ट्रातील शेतकरी संघटनांच्या चळवळीची आंदोलने - एक दृष्टिक्षेप	प्रा. संदीप राजभोज	८१ ते ८६
१७.	स्त्रीवादो चळवळ	डॉ. आर.पी. डेरे	८७ ते ९१
१८.	प्राचीन व मध्ययुगीन नेवास	प्रा. बाबासाहेब गंडाळ	९२ ते ९८
१९.	आदिवासी चळवळ	श्रीमती कायल शिंदे	९९ ते १०२
२०.	शेतो व शेतकऱ्यांच्या प्रश्नांचे पहिले भाष्यकार महात्मा फुले	प्रा. संदीप शिरसाठ	१०३ ते १०९
२१.	प्रताप हायरकुलच्या विद्यार्थ्यांचे राष्ट्रीय चळवळीतील कार्य	डॉ. सुनील अमृतकर	११० ते ११४
२२.	कर्मवीर दादासाहेब गाथकऱ्याड यांचे भूमिहानासतो कार्य	प्रा. प्रदीप फवार	११५ ते ११८
२३.	दलित चळवळ आणि वास्तव्य	डॉ. रघुनाथ चौधरी	११९ ते १२३
२४.	महात्मा फुले यांच्या दृष्टिकोनातून बीचतांचा इतिहास-एक विमर्श	श्री. फाकिरा राजगुरू	१२४ ते १३०
२५.	दलित चळवळीत राजर्षी साहू महाराजांचे शैक्षणिक योगदान	प्रा. दिनेश डोब	१३१ ते १३६
२६.	कां. बाबासाहेब काकडे : वचिताने कैवरी	डॉ. वज्रानन लोडे	१३७ ते १३९
२७.	Maryam Jmeelah A Shining Star of Islamic Movement	सौ. चुमरा शेख	१४० ते १४३
२८.	A Note on Tribal Societies of India	डॉ. मुस्ताक शेख	१४४ ते १५२
२९.	Raziya Sultan the Ideal Ruler of Del Sultanate	शेखद शहाबानो हेदरी	१५३ ते १५८

प्राचीन व मध्ययुगीन नेवासे

प्रा. गंडाळ आबासाहेब तान्हाजी
सहाय्यक प्राध्यापक,
इतिहास विभाग,
न्यू आर्ट्स कॉमर्स अँड सायन्स कॉलेज, पारनेर
जि. अहमदनगर

प्रा. डॉ. काकडे. बी. जे.
सहाय्यक प्राध्यापक,
इतिहास विभाग,
NACSP - Parner,
Ahmednagar.

मानव आपल्या उत्क्रांतीसाठी झटत असतो, विज्ञानाचे किंवा नैसर्गिक शास्त्राचे शोधाने असतो किंवा आपल्या उत्क्रांतीसाठी करत असतो. त्यामध्ये सामाजिक शास्त्रे तराे मागे कसे राहतोले? त्यांनी देखील आपआपल्या परीने त्यासाठी योगदान दिलेले आहे. सामाजिक शास्त्र इतिहास देखील मागे नाही. इतिहासात देखील नवनवीन संशोधने दिवसेंदिवस होत आहेत. इतिहासात वेगवेगळे प्रवाह येत आहेत, वेगवेगळ्या अंगांनी इतिहास अभ्यासाला जात आहे. वेगवेगळ्या पद्धतींनी इतिहासाचे विश्लेषण केले जात आहे.

इतिहासाच्या दृष्टीने विचार केला तर आज अनेक नवीन प्रवाह इतिहास अभ्यासाचे आणि संशोधनाचे आपणास पाहावयास मिळतात. त्यामध्ये स्थानिक इतिहासापासून उत्तर आधुनिक इतिहासाची कारणांमामा आपण पाहू शकतो. विचार आणि विचारातून होणारी कृती आपल्याला दुसरा विचार करण्यास भाग पाडतो. आणि त्यातून परत पुढचा विचार आपल्यापुढे येतो. हा विचार आपणास अभ्यास करण्यास भाग पाडत आहे. आणि अशा विचारातून स्थानिक इतिहास पुढे येताना आपणास दिसत आहे.

स्थानिक इतिहास प्रादेशिक व राष्ट्रीय इतिहासाचा अविभाज्य भाग आहे. स्थानिक इतिहासामुळे प्रादेशिक व राष्ट्रीय इतिहासामध्ये भर पडते. " इतिहास हा अतिशय व्यापक विषय आहे. अभ्यासाच्या सोयीसाठी वेगवेगळ्या प्रकारे त्याची विभागणी केली जाते. उदा. प्राचीन, मध्ययुगीन, आधुनिक अशी काळाच्या निष्कांवार केली जाणारी विभागणी. अशीच स्थलाच्या निष्कांवार केली जाणारी विभागणी म्हणजे जागतिक इतिहास, राष्ट्रीय इतिहास, प्रादेशिक इतिहास आणि स्थानिक इतिहास हा प्रादेशिक विभागाचाच पोट विभाग आहे." कोणत्याही एका छोट्या गावाची मंदिराची, किल्याची, पंढेची, किंवा व्यक्तीची माहिती गोळा करून त्याचा इतिहास लिहला जातो. तेव्हा तो स्थानिक इतिहास होय. त्याला एका विशिष्ट स्थानापुरते मर्यादित केले जाते फोकस हा विशिष्ट स्थानावरती असतो. त्यामुळे इतिहास समृद्ध होण्यास मदत होते.

स्थानिक इतिहास हा स्थलाकडून सुरुवात करून जाणारा आहे. एखाद्या विशिष्ट स्थानिक भागात जिथे राहणारे लोक त्यांच्या परंपरा राहणोमान व मुख्यतः संस्कृती तसेच मानांसकृतीचा अभ्यास हा स्थानिक इतिहासाचा मुख्य गाभा आहे. म्हणूनच स्थानिक व प्रादेशिक इतिहासाच्या पायावर राष्ट्रीय इतिहासाची भौगोलिक मर्यादा लहान आहे. प्रदेश ही संकल्पना सापेक्ष आहे. स्थानिक

इतिहासात गावांचा इतिहास समाविष्ट केला जातो. परंतु गावाच्या 'एखाद्या भागाचा, घेठ्या किंवा एखाद्या विद्यापीठाचा इतिहास हा देखील स्थानिक इतिहास म्हणून गणला जाऊ शकतो. एखाद्या स्थानाभोवती किंवा विभागाभोवती केंद्रीत राहून त्या स्थानाचे इतिहास लेखन करणे म्हणजे स्थानिक इतिहास लेखन करणे होय.' २

स्थानिक इतिहास हा प्रत्येक गावाला प्रत्येक परिसराला त्यात त्या गावातील ऐतिहासिक घराणे, समाजाच्या चालीरिती, परंपरा मंदीरे त्या गावाने इतिहासात जे जे म्हणून योगदान दिलेले असेल अशा सर्व घटकांचा समावेश हा स्थानिक इतिहासात होताना दिसतो. अनेक इतिहास संशोधकांनी स्थानिक इतिहासात छोट्या गावाचा इतिहास लिहिलेला दिसतो. तसाच अल्पसा प्रयत्न 'नेवासे' गावाविषयी मी करत आहे.

महाराष्ट्र ही संतांची भूमी आहे हा दगड धोंड्यांचा देश आहे. हा एकट व तापटोचा देश आहे असे अनेक उल्लेख आपणास साहित्यात महाराष्ट्राविषयी दिसतात त्यामुळे तेथील लोकांचा जीवनपध्दती कष्टकऱ्यांची जिद्द आणि साधी राहणी आपल्या लक्षात आल्यावाचून राहात नाही.

नेवासे हे गाव आधुनिक महाराष्ट्रातील अहमदनगर पासून ईशान्येला साधारण ५५ कि.मी. अंतरावर आहे. नेवासा हे आज तालुक्याचे मुख्यालय आहे. त्यावरून नेवासा तालुका हे नाव तालुक्यात दिलेले आपणास दिसून येते. १९° १९' ते १९° ४' उत्तर अक्षांश व ७४° ४८' ते ७५° ११' पूर्व रेखांशावर आज नेवासाचे स्थान आहे. हे गाव प्रवरा नदीच्या (गोदावरी नदीचा उपनदी) काठावर वसलेले आहे. अगोदर हे गाव प्रवरेच्या डाव्या तीरावरती होते. परंतु नदीने मार्ग बदलल्यामुळे आज या गावाचे नदीने दोन भाग केलेले आहेत. उजव्या तीरावरील गावास नेवासे खुर्द तर डाव्या तीरावरील गावास नेवासे बृद्धक असे म्हणतात. नेवासे खुर्द हे आज लोकसंख्येच्या दृष्टीने मोठे आहे. परंतु अंतराच्या दृष्टीने फक्त नदी मध्ये असल्यामुळे फारसा फरक जाणवत नाही. परंतु प्राचीन अवशेष हे जास्त नेवासा बु. येथे पहावयास मिळतात.

नेवासा या गावास तशी मोठी इतिहास परंपरा आहे. प्राचीन (इतिहास पूर्व काळापासून) ते अर्वाचीन काळापर्यंत नेवासाचा इतिहास पहावयास मिळतो. काही कागदपत्रांची कमतरता आणि नदीने मार्ग बदलल्यामुळे झालेल्या आलल्या ऐतिहासिक अवशेषांचे खंडन या बाबो मात्र इथे प्रभाव पाडतात. नेवासाच्या इतिहासाचे (प्राचीन व मध्ययुगीन) आपण दोन भागात विश्लेषण करू शकतो.

प्राचीन नेवासे :-

प्राचीन वाडःमयात कोरीव लेखात याचे उल्लेख मिळतात. ते निधोनावास, निधवास, निवास अशा भिन्न नावांनी आहेत. नेवासे येथे लाडमोड टेकाडात डेकून कॉलेजच्या वतीने स.१९५४ ते १९६० या काळात डॉ. सांकलिया व डॉ. हरावती कर्वे यांनी उत्खनन केलेले आहे. त्यामध्ये अनेक पुरातनवस्तु सापडलेल्या आहेत. इ.स.पूर्व दुसऱ्या दशकात तेथे वस्ती झाली होती. हे आपणास त्यावरून दिसून येते. ताम्रपाषाण संस्कृतीच्या काळातील हे लोक असून ते जांब संस्कृतीचे लोक आहेत. हे लोक तांब्याच्या कुऱ्हाडी छत्र्या व मासे पकडण्याचे गळ बापरत असत. त्याच बरोबर

दगडाचो घासुन गुळगुळीत केलेली नव, आश्रमयुगी साधने देखील आढळून आलेली आहेत. काळ्या रंगाचो नक्षी काढलेली भांडी, कळशा आणि मातीचे तवे येथील लोक वापरत असत. मणी देखील तीथे सापडलेले आहेत. “नेवासा वासियांच्या(तेथिल रहिवाशांच्या) जीवनात रोमन बनावटीच्या अनेक वस्तू जसे मोठ मोठाले मद्य, कुंभ, रोमन, काचेचे मणी अर्चना कुंडे इ. हया मिळाल्या आहेत.”^२ या वरुन त्यांचा व्यापारी संबंध हा रोमशी होता असे प्रथम दर्शनी वाटते. “नेवाशांच्या उत्खननात महाराष्ट्रातील ताम्रपाषाण संस्कृतीचा प्रस्तुत पुरावा पहिल्या प्रथम हाती घेऊन या लोकांचा नवअश्रमयुगीन लोकांशी निकटचा संबंध आला आहे हे उघड झाले.”^३

आजच्या नेवासा सा गावास निर्धोनिवास, निवास, महालय अशी नावे आढळतात. ही नावे कशी पडली व पुढे त्याचे नेवासा कसे झाले हे वेगवेगळ्या कथेतून समजते. “नेवासा संबंधी शिलालेख सापडणारा पहिला उल्लेख नऊरगाव येथील यादव रामचंद्र देव यांच्या शके १२०० (इ.स.१२७८) च्या शिलालेखात सापडतो.”^४ त्याच प्रमाणे नेवासाला महालय देखील म्हणत असत. त्याच्या देखील वेगळ्या कथा आहेत.

“महानुभवाच्या स्थापना पोथीत नेवासा चे वर्णन आलेले आहे. नेवासा गाव पुर्वी फार लहान होते. या गावाजवळ ‘माळी मोहतर्क’ म्हणून दुसरे लहान गाव होते. या दोन्ही गावापसुन पाव मैल अंतरावर ‘लाडमोड’ हे गाव होते.”^५ (लाडमोड हे यादवांच्या काळात महसुल गोळा करण्याचे ठिकाण म्हणून नमुद आहे.) पुढे या तीन्ही गावांचे मिळून नेवासा नदीच्या प्रवाह बदलामुळे परत त्याचे नेवासा खुर्द आणि नेवासा बुद्रुक ही दोन गावे तयार झाली. या गावाचा उल्लेख स्कंध पुराणात व माधत कतीच्या काव्यात आपणास मिळतात याला पौराणिक अख्यान देखील आहेत. “डोमोग्राम हुन निर्धोनिवास मागी चाचर मुनी असना डो मंगावाहुन नेवासेला जात. श्री चक्रधर चाचरमुनी मुक्काम क्षणभर करत होते.”^६ असा उल्लेख लिळा चरित्रात देखील आलेला आहे.

पुराण कथेनुसार कुबेराच्या निर्धोचा वास तो निर्धोनिवास असे महात्म्य आहे. तारकासुरास भिऊन राहणाऱ्यास सुरक्षीत ठिकाणी देवांनी मागुण घेतले तेव्हा गोदावरीच्या जवळ व प्रवरेच्या काठावर जागेची शिफारस विष्णुनी केली. व कुबेर आपले नऊ कोष घेऊन इथे राहिला. अशी अख्यायिका आहे.

नेवासेचे नाव महालय आहे. त्यावरुन दिसते त्याच प्रमाणे ‘जानेश्वरीत’ (भावर्थदिपीका) मिळणाऱ्या अल्लेखावरुन देखील सिध्द होते.

एसी युगी वरि काळी | आणि महाराष्ट्र मंडळी |

श्रीगोदावरीच्या कुळी | दविणिला ||

येथे भुवनैक पवित्र | अनादी पंचकोष क्षेत्र |

जगचे जीवनसूत्र | जेथे श्री मळस||

श्री जानेश्वरी, अध्याय १८ वा आद्यो १७८१मध्ये असा उल्लेख देखील आपणांस मिळतो. याला जोड म्हणून स्कंध पुराणानुसार समुद्रमंथनाचो अमृत वाटपाचो कथा देखील सांगितलो जाते. त्यावेळी निघालेल्या १४ रत्नांपैकी अमृताचे वाटप नेवासांत प्रयारातोंरो झाल्याचे सांगिल्ले जाते. त्यावेळेस विष्णुने मोहोनीचे रूप घेतलें हांतें, त्या मोहोनीराजाचें मंदिर हें नेवासांत आहे. (नेवासा खुर्द) तर खंडोबांची पत्नी म्हाळसा हिचे माहेर देखील नेवासांत आहे. (नेवासा वृद्धक येथे खंडोबाचें मंदिर आहे. तेन्ना नेवासा खुर्दास मोहोनीराजाचें नेवास असें नामाभिज्ञ देखील आहे. तेन्ना नेवासा खुर्दास मोहोनीराजाचें नेवासे आणि नेवासे वृद्धकास खंडोबाचें नेवासे नामाभिज्ञ देखील आहे, असें एक ना अनेक उल्लेख साहित्यांत आणि विशेष करून वैदिकसाहित्य आणि महानुभव साहित्यामध्ये प्राचीन नेवाशाचें आपणांस उल्लेख मिळतात. पण राज्य स्थापणे थियरी माहितो हि यादय काळापासुन पराव्यादाखल मिळते.

प्राचीन व्यापार वाघतल्यास नाणे घाट जून्नर, आळें नेवासे मार्ग प्रांत्यदान (आजचे पेटण) असा व्यापारी मार्ग होता. त्यामुळे प्राचीन काळांत देखील व्यापारांत नेवासे अग्रसर होते. लाडमोड टेकडावरील झालेल्या उत्खननांत देखील तशा रामशी व्यापारांत पुसटश्या खुणा आपणांस दिसतात हे महत्वाचे आहे. परंतु मध्ययुगांत मात्र एक व्यापारी पेट म्हणून नेवासा तितका पृढ आलेला आपणांस दिसत नाही.

मध्ययुगीन नेवासे-

दक्षिणेंतील काशी म्हणजे निर्धोनिवास नेवासे हे महाराष्ट्रांतोळ वादय राजांचे केंद्र होते. आणि महाराष्ट्रांतोळ थोर संत जानेश्वर विठ्ठलपंत कुलकर्णी यांनी जानेश्वरी देखील येथेच सांगितलेली आहे. तिचे लिखण नेवासा येथील रहिवाशी सचिनानंदबाबा कुलकर्णी १८ व्या अध्यायांतोळ शंघटची ओळी खूप बोलकी आहे.

शके बाराशे बारात्तरे | वैदिका केली जानेश्वर | सचिनानंदबाबा आदरे | लखक जहाला | म्हाळसा मोहोनीराज मंदिरामुळे हे तिर्थ क्षेत्र विशेष प्रसिध्दोस आले आहे. शिवभारत कर्ता कविद्र परमानंद हा निर्धोनिवासकार (नेवासकर) होय.

“औरंगजेबाच्या कैदेत असताना छत्रपती संभाजी पुत्र छत्रपती शाहुंचे लग्न औरंगजेबाने लावून दिले. त्या वेळेस त्याने हा भाग शाहुला लग्नांत आंदण म्हणून दिला होता. कैदेतून सुटून आल्यावर शाहुने प्रथम आपला अमल या भागावर सुरु केली” अगोदर हा भाग यादवांच्या काळांत यादवाच्या अमलाखाली होता व त्यानंतर तो पुन्हा शाहुच्या रुपाने मराठ्यांच्या अमलाखाली आला. मधल्या काळांत अगोदर निजामशाहींत हा भाग समाविष्ट होता. परंतु निजामशाही वुडाल्याने नंतर तो भाग मोघलांच्या ताब्यांत आला. मोघलांकडून परत मराठ्यांकडे त्याचा प्रवास झाला इ. स. १७२४ नंतर हा प्रांत हैद्राबादच्या निजामाने घेतला उदगौरच्या लढाईच्या वेळी इ. स. १७६० मध्ये

पेशव्यांचा अंमल या ठिकाणी आला. पेशव्यांचा सुबेदार नारं बाजी नगरकर याने या भागाचा पुनर्रचना (प्रशासकीय) केली.

शाहू नंतर पेशवे सर्वसत्ताधीश बनले पेशव्यांच्या काळात इ. स. १७६० ला हा भाग होळकरांकडे आला तो इ.स. १८०० पर्यंत नंतर इ. स. १८०० ला तो ब्रिटिशांनी ताब्यात घेतलेला दिसतो. म्हणजे होळकर सोडून दिर्घकाळ या प्रदेशावर कोणाचेही राज्य मध्ययुगात राहिलेले आपणास दिसून येत नाही.

निजामशाही राज्या जेव्हा शहाजी भोसले काम करत होते. तेव्हा त्यांचा देखील सहवास नेवासाला लाभल्याचे दिसते. त्याच बरोबर मलिक अंबरने आपलो प्रतवारी पध्दती (जमिन महसुलाची) देखील येथे राबवलेली आपणास दिसते. मध्ययुगीन नेवासात औरंगजेबाचे देखील वास्तव्य काही काळ झाले होते. नेवासा वृ. येथे असणारे नारद मुनींचे मंदीर (जगाच्या पाठीवर इतरत्र कोठेही नारदमुनींचे मंदीर नाही असा समज आहे) त्याने पाडले व त्याच भग्न अवशेषांचे परत दुसरे मंदीर बांधलेले आहे. ते आज बऱ्यापैकी स्थितीत आहे पण तेथे कबर आहे. परंतु हिंदूंचा घंटा देखील तिथे पहावयास मिळते. दुसरी काही खुण नाही हिंदू व मुसलमान तेथे मनोभावे पूजा करतात जेव्हा अहमदनगर या ठिकाणी औरंगजेब मृत पावला तेव्हा त्याचा मृतदेह औरंगाबादहून येताना नेवासा येथे टेकवला होता. त्या ठिकाणी तक्रिया म्हणतात तेथे एक पिराचे ठाणे आजही पहावयास मिळते. तेथील व्यवस्था पाहण्यासाठी एका मुस्लिम व्यक्तीला ६ एकर जमिन दिली होती. आज त्याने ती त्याचा मालकीची करून घेतली आहे.

प्रवरा नदीच्या काठावर गणपती, घाघऱ्या घाट आहेत हे घाट होळकरांनी बांधलेले आहेत. त्याचप्रमाणे घाघऱ्या घाटावर प्राचीन महादेवाचे मंदीर आहे. त्यात एका वेळेस एकच माणूस जाऊ शकेल अगदी तेवढेसे ते मंदीर आहे. मोहणोराजाचे जे जुने मंदीर होते (त्याला पाकशाळा असे संबोधले जात असत) ते प्रवरा तोंडावर होते. तो पाकशाळा पाहून ट्रस्टने तिथे दुसरी इमारत बांधली आहे.

नेवासेत अतिशय चांगल्या स्थितीत असलेले सध्याचे मोहनराजाचे मंदीर हे होळकरांचे सरदार गंगाधर यशवंत चंद्रचूड यांनी बांधलेले आहे. (चंद्रचूडांना नेवासा परिसरातील २२ गावे जहागिरी म्हणून होळकरांनी दिलेली होती) मंदिरासाठी चार हजार कामगार चार ते सहा वर्षे काम करत होते चार ते पाच लक्ष रुपये खर्च झाला. पेशव्यांनी दर साल १५०० रुपये वार्षिक अनुदान दिले होते. ते १८६० पर्यंत मिळत होते. या मंदिराचे पूर्ण काम इ.स. १७७४ साली पूर्ण झाले. इनाम कमिशनने १८६१ ला अनुदान बंद केले ब्रिटिश सरकारने २४८ रुपये अनुदान प्रतिवर्षी देण्यास सुरुवात केली. सध्याचा खर्च देवस्थानाच्या जमिनीतून व इतर मिळकतीतून केला जातो. या मंदिराची उंची ७५ फूट असून, मंदिराची बांधणी दगडी असून कलाकौशल्याने परापूर्ण आहे. नाशिक येथील मंदिराच्या बांधणी प्रमाणे या मंदिराची बांधणी वाटते.

नेवासामध्ये आणखी ज्ञानेश्वराचे मंदिर देखील आहे, परंतु जुने मंदिर पाडल्यामुळे आज त्या ठिकाणी दुसरे मंदिर बांधलेले आहे. ते मंदिर एका दगडी खांब्यासाठी आहे. त्या खांब्याला टेकून

ज्ञानेश्वरांनी ज्ञानेश्वरी सांगितली असे म्हणतात. त्या खांबावर चंद्र आणि सूर्य कोरलेले आहे. त्यास पैशाचा खांब असे नामाभिज्ञ आहे. (पैस) त्याचप्रमाणे नेवासात मध्ययुगीन मशिद हया देवळाच्या जागेवर देवळे पाडून बांधल्या असे म्हणतात. त्या मशिदीच्या दगडावर जुणे कोरलेले नक्षीकाम देखील तसेच आहे. प्रवरानदीच्या पात्रात आपण फिरल्यास अनेक नक्षीकाम केलेले दगड आपणास आढळून येतात. त्याची माहिती मात्र मिळत नाही.

गंगाधर चंद्रचूड या होळकरांच्या सरदाराचा वाडा नेवासा बुद्रक येथे आहे. व्यापाराच्या दृष्टीकोनातून नानेघाट ते पैठण या मार्गावर नेवासे होते. यात्रा उत्सव हे वेळोवेळी भरत असत. मोहनिराजची यात्रा भरत असे. त्याचप्रमाणे नेवासा बुद्रक पासून दिड मैल अंतरावर असणाऱ्या बहिरवाड येथे बहिरवाडीची (भैरवनाथाची) यात्रा भरत असत. त्या ठिकाणी मोठे आर्थिक व्यवहार होत असत. तात्पुरती बाजारपेठ निर्माण केली जात असत, परंतु मुख्यतः शंतीवरतीच भर होत आणि आजही जास्त भर हा शंतीवरतीच अवलंबून दिसतो.

इ. स. १८०० ला नेवासा हा होळकरांकडून ब्रिटिशांकडे गोल आणि त्यानंतर स्वातंत्र्य प्राप्ती पर्यंत त्यावर ब्रिटिशांचेच वर्चस्व राहिले. तेथे जवळ वडाळा येथे मिशनरी स्थापन होऊन त्याचा प्रभाव नेवासावर देखील पडलेला दिसतो. नेवासाने स्वतंत्र चळवळीत देखील आपले भरोव योगदान दिलेले आहे. त्या संबंधीची यादीच आपणास नेवासा तहसिल कचेरीत पहावयास मिळते. आज मुस्लीम व हिंदू त्याच बरोबर ख्रिश्चनांचा देखील वावर नेवासात आपणास दिसून येतो. समाजात असणाऱ्या सर्व धर्मांचे उत्सव हे आनंदाने तिथे साजरे होतात.

नेवासाच्या प्राचीन व मध्ययुगीन इतिहासास संशोधनास आजून मोठ्या प्रमाणात वाव आहे. त्याचप्रमाणे त्यामुळे स्थानिक इतिहासाकडे पाहण्याचा आपला दृष्टिकोन बदलून मोठ्या प्रमाणात संशोधन होण्यास मदत होते. नेवासाच्या इतिहासामुळे आपणास जेव्हा संस्कृतीपासून मराठ्यांच्या प्रशासन व्यवस्थेपर्यंतची माहिती मिळते. मंदिरामुळे इतिहास समजण्यास मदत होती. समाजव्यवस्था समजण्यास मदत होती.

स्थानिक इतिहासात नेवासा या गावच्या इतिहासाचे महत्व अनन्य साधारण आहे. हे मात्र खरे

तळ टिपा

- १) प्रा. डॉ. लहू गायकवाड व डॉ. श्रीकांत फुलसुंदर, ऐतिहासिक दुर्ग नारायणगड लोक संस्कृती प्रकाशन नारायणगाव, प्रथम आवृत्ती २०१२ पृष्ठ क्र ९
- २) तर्कतिथे लक्ष्मण शास्त्री जोशी (संपादक) मराठी विश्वकोष -खंड ८ वा महाराष्ट्र राज्य सांस्कृतिक मंडळ मुंबई, प्रकाशन- १९७६ पृष्ठ क्र-९४४
- ३) किल्ला पान-९४५
- ४) प्रा. रामनाथ नन्नवर, 'नेवासा तालुक्यातील मंदिरांचा इतिहास', एम. फिल प्रबंध (अप्रकाशित) पुणे विद्यापीठ पुणे, पृष्ठ क्र-५७

- ५) प्रा. डॉ. चंद्रकांत आर्षंग, 'भारत इतिहास संशोधक मंडळ' गौमासिक, पेशवे कार्निव जत्र व त्यांचे प्रशासन अंक १ ते ४ वर्ष १९९७-१९९८ पृष्ठ -१६
- ६) ए. ना. नेने भारत इतिहास संशोधक मंडळ पुणे त्रैमासिक तेराव्या शतकातील नेवास (महानुभव साहित्याच्या आधारे) अंक दुस-या , वर्ष-१९३८ पृष्ठ -५४
- ७) प्रा. डॉ. चंद्रकांत आर्षंग, भारत इतिहास संशोधक मंडळ पुणे गौमासिक, पेशवेकार्निव जत्र व त्यांचे प्रशासन", अंक १ ते ४ वर्ष १९९७-९८, पृष्ठ क्र १६

संदर्भ ग्रंथसूची

- १) प्रा. आर्षंग चंद्रकांत 'भारत इतिहास संशोधक मंडळ पुणे त्रैमासिक' पेशवे कार्निव जत्र व त्यांचे प्रशासन, अंक १ ते ४, वर्ष १९९७-१९९८
 - २) बडवे नरहर मुरलीधर 'श्री मोहनराज कथासार व नित्य उपासना बडवे प्रकाशन नेवासा २०१२
 - ३) प्रा. गायकवाड लहू व पा. फुलसुंदर श्रीकांत राव्याहासिक दुर्ग नारायणगड लोकसंस्कृती प्रकाशन नारायणगाव प्रथम आवृत्ती - २०१२
 - ४) गुप्ते य. रा. 'भारत इतिहास संशोधन मंडळ पुणे, त्रैमासिक' 'नेवासे येथील प्राचीन अवरोध' अंक १ ला इ.स.१९३८
 - ५) दिक्षित राजा 'इतिहास शिक्षक त्रैमासिक' प्रादेशिक इतिहासाच्या वर्तमान संदर्भ आक्टो - २००४
 - ६) देशपांडे ब्रह्मानंद शोधमुद्रा खंड २ कैलास पब्लिकेशन्स औरंगाबाद
 - ७) प्रा. नन्नवरे रामनाथ 'नेवासा तालुक्यातील मंदिराच्या इतिहास' एम. फिल प्रबंध अप्रकाशित पुणे विद्यापीठ पुणे.
 - ८) नेने ह.ना. 'भारत इतिहास संशोधन मंडळ' पुणे, त्रैमासिक, तेराव्या शतकातील नेवास (महानुभव साहित्याच्या आधारे) अंक दोन २१ इ.स १९३८
- प्रत्यक्ष भेटी
 - १) डेक्कन कॉलेज वस्तुसंग्रहालय पुणे- २५ मार्च २०१४
 - २) मोहनराज मंदिर नेवासे- २९ मार्च २०१४
 - ३) नारदमुनी मंदिर नेवासे बुद्रुक- २९ मार्च २०१४
 - ४) जानेश्वरी मंदिर नेवासे- २९ मार्च २०१४
 - प्रत्यक्ष मुलाखती
 - जयंत नरहर बडवे नेवासा - २५ मार्च २०१४
 - रामनाथ नन्नवरे नेवासा - ३० मार्च २०१४

31. Pros & Cons of Indian Nationalism: Is India a Nation



**Golden Jubilee Year 2019-20 of
Department of Political Science
&
Shivaji University Political Science Association
Conference Proceeding of Two Days National Seminar
&
37th Maharashtra Political Science & Public Administration Conference
“Contemporary Issues in Political Science”
10th & 11th January 2020**

**Editor
Prof. (Dr.) Ravindra Bhanage
Head of Department,
Political Science, Shivaji University, Kolhapur**



**ISSN - 2277 - 8063
International Interdisciplinary research Journal
(Humanities, Social Sciences, languages, Commerce & Management)**

PROS AND CONS OF INDIAN NATIONALISM IS INDIA A NATION?**Shri. Virendra Shankar Dhanashetti**

Associate Professor and Head of the Department Political Science,
New Arts, Commerce and Science college, Parner, Dist. Ahmedagar-414201.
dhanashetti_vs@yahoo.co.in virendradhanashetti@gmail.com
9420635158, 9284713945

Abstract: This article deals with now a day's political questions in Indian Polity as fundamentalism is encroaching the spear of day to day life of Indian citizens. Citizenship, Migration and identity crisis seen in Indian Polity is making us to think again on basic foundations of various aspects of Political terminology used in Indian Politics in general. Basically Nation-State concept which evolved in modern era in European Continent has different aspirations among the peoples of those countries. In Indian scenario we find it very hard to elaborate the Nation State concept as a whole comparatively. In this article all the details of nation state concept have been taken in considerations. In a nutshell we can say that Indian Nationalism has great legacy since ancient era. In modern times this will survive and even contribute to world community at large.

Keywords: Indian Nationalism, Nation Building Process, Hinduism, Divisive Forces, Secularism.

India is a Nation :-

- **Nation-building - Cohesive Forces**

The people of India inhabit a common land, popularly known as our "Bharat Varsha", or "Bharat", our motherland and have common cultural unity, and above all, political aspirations, community of economic interests, fundamental common historical background, which make them, feel proud of their past glories and keep them psychologically and emotionally united.

There are many factors and forces, which have gone a long way in moulding and uniting various racial, religious, linguistic, and cultural groups into a nation and promoting as well as preserving national unity and political cohesion of our country. Broadly speaking, cohesive and unifying forces in India may be identified as under:

1. Role of National Leaders in Nation Building :

In the process of nation-building, sane and sound guidance, political acumen, unqualified dedication, and total devotion of an able leadership play a significant role. Such outstanding leaders and elites can eliminate, to some extent, unhealthy and negative tendencies, promote healthy political order, civic virtues, alter adverse economic conditions, abolish social evils, and, in general, improve socio-eco-political structure within the country. Such national leaders can lead people to achieve political independence and guide them to overcome geo-political obstacles of their environment.

India has been singularly fortunate in having such national leaders with multi-splendored personalities, such as, **Dadabhai Naoroji, Gopal Krishna Gokhale, Bal Gangadhar Tilak, Mahatma Gandhi, Pandit Jawaharlal Nehru, Subhash Chandra Bose, Dr. Rajendra Prasad, Dr. B.R.Ambedkar, Sardar Vallabhbhai Patel, Lal Bahadur Shastri, Priyadarshini Indira Gandhi, Dr. Sarvapali RadhaKrishnan and Rajiv Gandhi**, who have played pivotal roles in cementing bonds of national unity and political cohesion and national integration of our country. They rose above the narrow boundaries of caste, class, creed, sex, place of birth and parochial loyalties, and always thought in terms of nation as a whole and thus set unique examples for the masses to follow.

Dadabhai Naoroji and Gopal Krishna Gokhale were the earliest two national leaders, who led the Indian national movement. The slogan of **Bal Gangadhar Tilak**,

"Swaraj is my birth right and I will have it", generated national consciousness and feeling of oneness among all Indians.

Mahatma Gandhi, popularly known as "Bappu" or "father of Indian nation", was the moving spirit in the Indian national movement- he was the torch-bearer of the Rowlatt Satyagraha (1919), the Non-violent Non-Co-operation Movement (1920), the Individual Satyagraha (1940), and the Quit India Movement (1942), which galvanized the national spirit throughout the length and breadth of our country.

Subhash Chandra Bose organised on July 8, 1943, the Azad Hind auz (the Indian National Army) to liberate India from the iron chains of England. Dr. Rajendra Prasad, Dr. B.R. Ambedkar, Pandit Jawaharlal Nehru and Sardar Vallabhbhai Patel played a very important role in framing the parliamentary democratic constitution of the Republic of India on secular basis.

Pandit Jawaharlal Nehru, the first Prime Minister of India, followed by Lal Bahadur Shastri, and Priyadarshini Indira Gandhi, respectively, were truly the "makers of their age" in the sense that they attempted, with a great measure of success to correct social abuses in Indian society and establish a better social order, introduce economic policies for material welfare and an all-round prosperity, and set in motion tendencies for promoting national integration of our country. Dr. Sarvapali Radhakrishnan was the first philosopher-President of India, the world has ever known.

2. Geographical Contiguity:

Geographical contiguity of the Indian sub-continent has gone a long way in fostering national consciousness among the masses in our country. Though India is a vast sub-continent, it has well marked geographical boundaries from north to, south and east to west, which distinguish and demarcate it from the rest of the world. The people of India have always this geographical image of India in their minds from the time immemorial. The figure of India, its flora and fauna, its mountains and rivers, its beauty and sand and the national anthem have all contributed to national unity of our country.

3. Democratic Constitution and Federal Set-Up :

The founding fathers in the Constituent Assembly of India adopted and enacted on 26th Nov., 1949, a parliamentary democratic constitution with federal set-up, which is, thus far, the greatest cohesive force of Indian nation-building.

- i) The parliamentary democratic constitution provides for political institutions in which the grievances of the people find constitutional expression and the governmental authority is made responsive to the hopes and aspirations of the electorate. Democratic process provides equal opportunities to all persons, irrespective of caste, color, creed, sex, and place of birth, to participate fruitfully in the nation's constructive activities. Indeed, in secular India, special provisions are made in the Constitution of India for the protection and promotion of the interests of minority communities, which enable them to rise to the highest positions in public life.
- ii) In a multi-racial, multi-religious, and multi-lingual nation like India, with diversity of culture, economy and geography, the federal set-up provides for local autonomy and allows the local people to manage their local affairs in their own way. Regional autonomy satisfies regional aspirations without any loss of national unity and political cohesion.

4. Administrative Unification of the Country :

Administrative unification also contributes to the political integration of the country. During the British rule in India, the well-organized Indian Civil Service (I.C.S.) brought about the administrative unification of our country. In

post independent India, the bureaucracy, on the whole, is secular and committed to the unity of the nation.

5. Common Historical Background and Cultural Heritages :

Common historical background and evolution and continuation of a composite culture during the course of several centuries have also gone a long way in fostering national consciousness among Indians.

No Indian can ever forget the glorious and unique role, played by **Mahatma Gandhi** in the Indian National Movement and his tireless efforts to achieve national harmony within the country. **Sardar Vallabhbhai Patel** will also be always remembered for bringing about permanent political unification and merger of most of the Indian native (princely) states with India at the time of independence of our country. The dynamic roles, played by **Pandit Jawaharlal Nehru**, **Lal Bahadur Shastri**, and **Smt. Priyadarshini Indira Gandhi**, on the socio-economic-political scene of India will always be recounted by all Indians with a great sense of pride and respect for them. Our cultural heritage, including Indian philosophy, the two great epics-the Ramayana and the Mahabharata-the Bhagvat Gita and the Upanishadas, have exercised tremendous influence on the Indian mind and have made Indians feel as one nation. ;

6. Liberal and Tolerant Hinduism:

Another cohesive factor in nation-building in India has been the inner strength of tolerance of Hinduism towards all other religions of the world, which are being followed in our country. The Hindus account for the largest community constituting about 84% of the total population of India. During the course of the long history of Hinduism, it has become liberal and tolerant towards all non-Hindus. Moreover, it has become flexible and wide enough in scope to embrace all attitudes and views within its fold. This has made Hinduism a stabilising force, a unifying force, in the turbulent life of the Indians in our country.

7. National Armed Forces :

The armed forces in India have played a significant role in preserving the national unity and its territorial integrity. They have always viewed the defense of the country as their supreme duty. The recruitment and composition of the armed forces in India is secular in character; the recruitment is made without any consideration of caste, creed, color, caste, sex, religion, place of birth, and racial discrimination. By its role of preserving and defending the territorial integrity of India and national unity, the armed forces in India have always acted as one of the cohesive factors in nation-building.

8. Judiciary :

Judiciary, i.e., courts of law, in India, particularly the Supreme Court and the High Courts in States, have always acted as a unifying force in and positive judgments, they have always upheld the country's territorial integrity and sovereignty and thus proved to be an integrating force of great value.

9. Common Man's Will to be a Nation :

Finally, common man's will to be a nation is the greatest cohesive force in our country. This burning desire for national unity has been demonstrated time and again whenever the country has passed through critical times or faced any external threat or internal dissension. There have been numerous occasions when Indians have exhibited a dynamic force of Indian nationalism as under,

- i) In 1942, at the call of Mahatma Gandhi, the people of India rose as one nation and joined the "Quit India Movement" against the British.
- ii) When India won political independence on 15th August 1947, her citizens, irrespective of castes; creeds, religions, languages, went wild with joy.

- iii) On January 30, 1948, when Mahatma Gandhi, was shot dead, Indians mourned as a nation the loss of the father of the Indian nation.
- iv) Again when Pandit Jawaharlal Nehru, the first Prime Minister of India, passed away on May 27, 1964 and when another Prime Minister, Lal Bahadur Shastri died of heart attack at Tashkent in the U.S.S.R. on January 11, 1966, Indians deeply mourned as a nation the loss of their beloved national leaders, irrespective of caste, creed, religion, language or party affiliations.
- v) In October, 1962, when China committed aggression on India and again in August 1965, when Pakistan launched an undeclared war on India, and once again in December 1971, when Pakistan attacked India, the whole world realized that the atmosphere in India was charged with patriotic and national spirit. The national interest became the supreme interest and all other interests - personal, private, regional, communal, linguistic, and religious - were completely forgotten.
- vi) When our beloved Prime Minister Smt. Priyadarshani Indira Gandhi was brutally assassinated on October 31, 1984 all Indians deeply mourned as a nation for the loss of their national language. Is this not a sufficient testimony to prove that India is a nation?
- vii) In the recent Assembly elections in the State of Jammu and Kashmir, the electorate overwhelmingly rejected the forces of disintegration, as represented by Muslim fundamentalists. This was perhaps a unique example of the common man's will to be a nation-his iron determination to preserve the national unity.

- **India is not a Nation**

- **Divisive Forces or Dangers to Indian Nationalism :**

In spite of a number of unifying forces promoting and preserving the national unity and territorial integrity of our country, there are several divisive forces, which are threatening to destroy the fabric of national unity and territorial integrity in India.

1. **India as a Sub-Continent With Multiplicity of Castes, Cultures, Races, Religions and Languages :**

In the eyes of many Western writers and Indians as well, India is nothing but a vast sub-continent, characterized by multiplicity of castes, cultures, races, religions, languages and regional differences. The Hindus constitute the largest single group. Even within the Hindu religion, there are too many castes and sub-castes. These minority communities have their own way of life, their own religious beliefs and practices, rites and rituals and ceremonies, their own languages and dialects, and their own customs and usages, and, thus, have preserved their distinct entities. Indians constitute a mass of heterogeneous groups, which can hardly be welded together into a nation. India, they conclude, is no more than a mere "geographical expression".

2. **Disunity among Groups :** These racial, religious, linguistic, cultural, and caste groups in India have always remained disunited especially before Independence, and fought with one another on religious, communal, caste, regional and linguistic considerations in the country. Such groups and communities which are antagonistic in nature, can hardly enjoy the special spirit of unity on an emotional, psychological and spiritual basis which, in the words of Prof. Harold Laski, "marks off those who share in it from the rest of mankind". The problem of national integration has become very serious in

India because divisive forces of caste, creed, race, religion, language and communalism create social tensions and eat the very vitals of national unity. Hence, they point out that it is easier to find a Hindu, a Muslim, a Christian, a Sikh, a Jain, a Buddhist, a Jew, a Bengali, a Maharashtrians, a Gujarati, a Tamilian, and a Keralite than an Indian in India.

3. Two Nation Theory

India was partitioned into India and Pakistan on the basis of Two Nation Theory. The Two Nation Theory was advocated by the supporters of partition, and opposed by the supporters of an Undivided India. It was pointed out that there were two major communities, namely, the Hindus and the Muslims, in addition to many other smaller religious minorities like the Christians, the Sikhs, the Jains, the Buddhists, etc. in India. **M.A. Jinnah**, the great champion of the "Two Nation Theory" asserted that Mussalmans are a distinct nationality according to any definition of a nation and hence, they must have their own homeland, their territory and their state. In spite of their centuries of close association and sympathetic intercourse, the Hindus and the Muslims remained separate. The two streams could not mix together. They were two different nationalities in India. The inevitable Partition, therefore, took place.

4. Communalism

It is the most potent divisive force in Indian politics. It was in fact the "Two-Nation Theory" based on communalism, particularly Muslim Communalism, which led to the Partition in 1947. Even after independence, communal note have become the order of the day everywhere throughout the length and breadth of the country. During the period between 1976 and 1982 as many as 1,940 communal riots folk in India. In one single month of April, 1987, as many as 32 incidents of riots were reported in Gujarat Every political party, without exception, makes use of religion for gaining political advantage. Even and the Congress have not hesitated to ally themselves with forces to gain temporary political advantage.

5. Regionalism .

Regionalism is another potent divisive force in stands for local loyalties and lays emphasis on regional language regional culture and regional priorities even at the cost of assumes different forms at different times, at different Indian politics.

6. Doctrine of Sons of the Soil

The mild form of regionalism is characterized by what is known as the doctrine of "Sons of the Soil". It stands for giving top priority to the local people, who are described as the "sons of the soil", in all activities of development, particularly in matters of job and economic opportunities, housing, finance, government loan and bank credit facilities for establishing industries or business.

7. Nativism

In its another form, it is characterized by a movement, which is known as "nativism" in politics. It stands for glorification of regional culture and local heroes and revival of traditional ways of life; hence, it may cause violent opposition to the so-called outsiders. In the state of Assam, for example, the "sons of the soil" violently opposed the so-called outsiders because of the fear that uncontrolled entry of outsiders may, one day reduce the local people to a minority and thereby they may not only be deprived of economic power but also of political power by the so-called outsiders.

8. Intra-nationalism

Finally, in its worst form, regionalism is characterized by what is known as "intra-nationalism". It demands separate sovereign state and therefore secession from the federal polity. In the Punjab, the separatist movement, led by fundamentalists, poses a very serious threat to the national unity and territorial integrity of our country.

9. Linguism

Linguism is another source of danger to Indian nationalism. Linguistic chauvinism has increased in dangerous proportions in recent years. The English had played* pivotal role in unifying India during the British rule in India. However, today,, loyalty to a regional language comes in the way of developing a common all-India national language.

On January 26, 1965, when the Government of India installed Hindi as the Principal Official Language, of the Union, there were anti-Hindi riots almost all over the South and West Bengal, where public property was looted and destroyed, lawlessness, chaos and anarchy spread with such force that even then unity of India was in danger. The situation was calmed down only when the Parliament passed the Official Languages (Amendment) Act, 1967, by which a statutory guarantee was given to the; South that English would not be replaced by Hindi for any purpose in the Union unless and until the non-Hindi States themselves were ready for the switch-over.

Anti-English fanatics staged ugly and violent demonstrations against the Official Language (Amendment) Act,-1967, in some parts of Northern India. The Anti-Hindi fanatics followed suit by launching anti-Hindi violent demonstrations.

The formation of linguistic states like Andhra Pradesh and Tamil Nadu (October 1953), Maharashtra and Gujarat (1960), the Punjab and Haryana (1966), Mizoram, Meghalaya and Arunachal Pradesh have done great harm to the country. There appears to be an organic connection between the demand for Khalistan and Gorkhaland and the linguistic states, as both are forms of separatism.

10. Casteism

It is another potent divisive force in Indian nationalism. It profoundly influences every aspect of social, economic and political life at every level. The constitutional provisions regarding the protection and promotion of the interests of the scheduled castes and the scheduled tribes and other weaker sections of the society have instead of weakening the caste system, further strengthened it. Of late, caste riots have become the order of the day and have become more cruel and inhuman. The caste war between the high caste and the low caste has become very frequent in certain parts of our country and thus cuts into the very vitals of Indian unity.

11. Poverty and Economic Inequalities

Finally, poverty and economic inequalities pose a serious danger to the national unity and the stability of our political system. In the post-independence era, the benefits of economic development in India have mostly been enjoyed by upper sections of the Society.

In the last twenty years, absolute poverty in India, according to Dr. B.S. Minhas, has increased. According to an estimate of the sixth five- year plan, 49 percent of the total population in India was still below the poverty line. Moreover, nearly 50 percent of the total population in India is under-nourished. Population explosion has further aggravated the problem of poverty in India.

Poverty and economic inequalities result into social injustice, which, in turn, can destabilize democratic political system and threaten national unity.

In the last two decades, communalism, regionalism, linguism and casteism, have played havoc in our country. Murder, loot, arson, and knifing, as a result of communal riots and linguistic fanaticism in many parts of India, have now become a painfully regular phenomenon. M.V. Kamath has aptly remarked:

"For years, we have been fooling ourselves that we are civilized. Our civilization is skin-thin. Civilized people don't go round killing the mno- cent whether in Muktsar or Meerut; Sultanpur, Pilibhit, Shahjahanpur, Jaunpur and Allahabad have become permanent blots on India's post-independence history, as have Ahmedabad and Baroda. Hatred thrives, hatred of another man's religion and another man's language".

He further writes : "Linguistic fanaticism is being mistaken, for love for one's mother tongue. Learn our language or leave our State is the cry of the misguided. Sub-nationalism is being fanned to the point of destroying the essential unity of the nation (The Times of India. Sunday Review, p.L August, 17,1986).

Dr. Asirvatham has rightly warned. "If India is to survive in the modern world, it is necessary that we should at once replace village politics, caste politics, and tribal politics by national politics." He adds, "Politics divides us, religion divides us, culture divides us. But the land and love of the land of India may unite us." Further, Indian politics must be secularized, and we must respect each other's religious beliefs and practices.

To sum up, we must feel that we are not Hindus, Muslims, Christians, Parsis, Sikhs, Madrasis, Bengalis, Pubjabis, Maharashtrais and Gujarati's, but "Indians". Our loyalty should not be to Maharashtra, Mysore, Gujarat or Tamil Nadu, but to India - India first, India next, and India last – should be our "article of faith".

References

- i) Bhagwan Josh, Nationalism, Third International and Indian Communists, Bipin Chandra ed, The Indian Left-Critical Appraisals. Vikas Publishing House, 1983.
- ii) J. Nehru. The Discovery of India, London 1956.
- iii) Gail Omvedt and Bharat Patankar, Notes on the National Question, Frontier
- iv) E M S Namboodiripad, The National Question in Kerala, PPH Bombay, 1952.
- v) Irfan Habib, Emergence of Nationalities, Social Scientist, 37, August 1975.
- vi) Ajit Roy, Some Aspects of the National Question in India, Marxist Review, October 1967.
- vii) Niharranjan Ray, Nationalism in India, Aligarh 1973.
- viii) Report on the Hind Backward Classes Commission, Vol I.
- ix) Praksh Karat, Language and Nationality Politics in India, Madras, 1973.
- x) Myron Weiner, Sons of soil : Migration and Ethnic Conflicts in India, Princeton, 1983
- xi) Bipin Chandra, Nationalism and Colonialism in Modern India, New Delhi, 1979.
- xii) A. R. Kamath, Ethno-linguistic Issues in Indian Federal context, Economic and Political Weekly, Vol. 15, June 14-21, 1980, PP 1053-1066.

32. Contribution of Achievements of Women In Various Field at National & International Levels :- Women are the Real Architect of Society

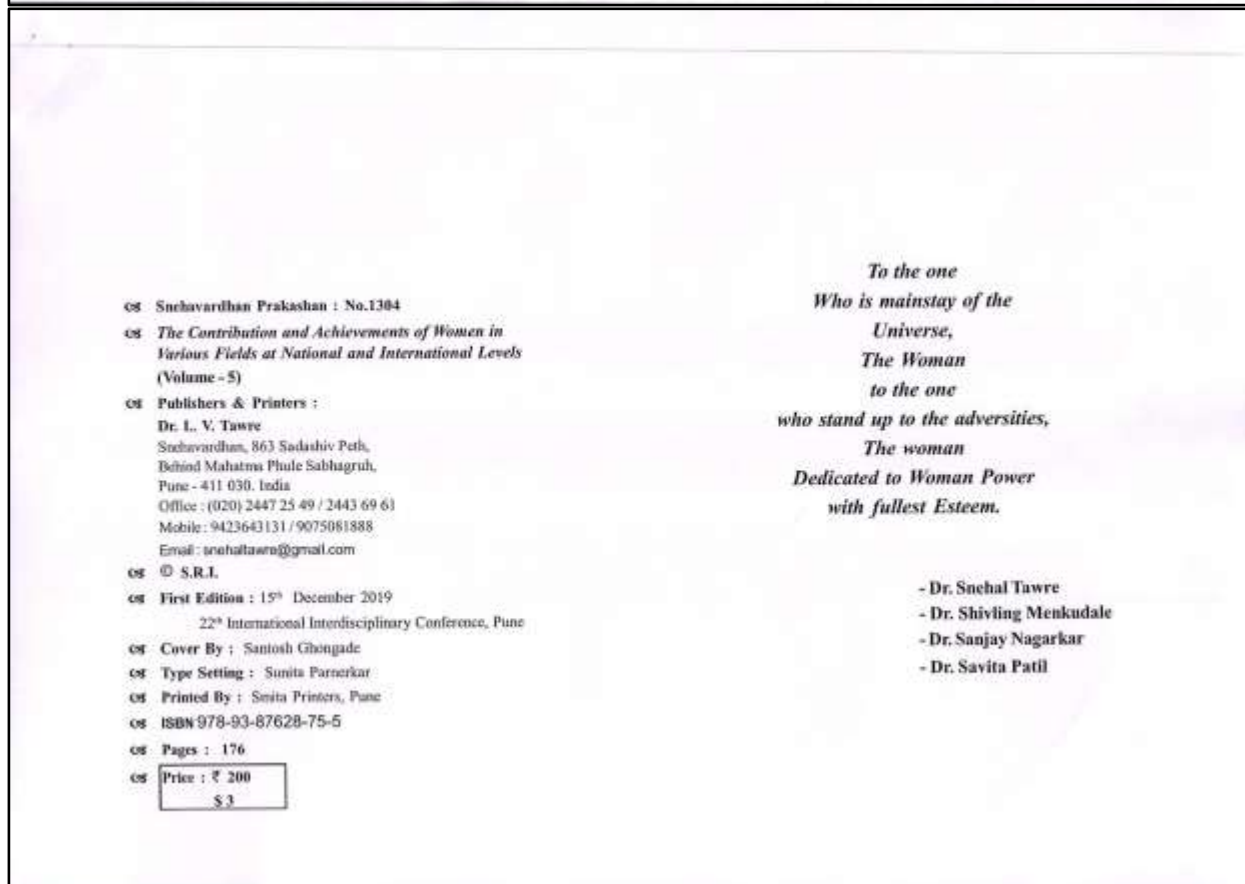
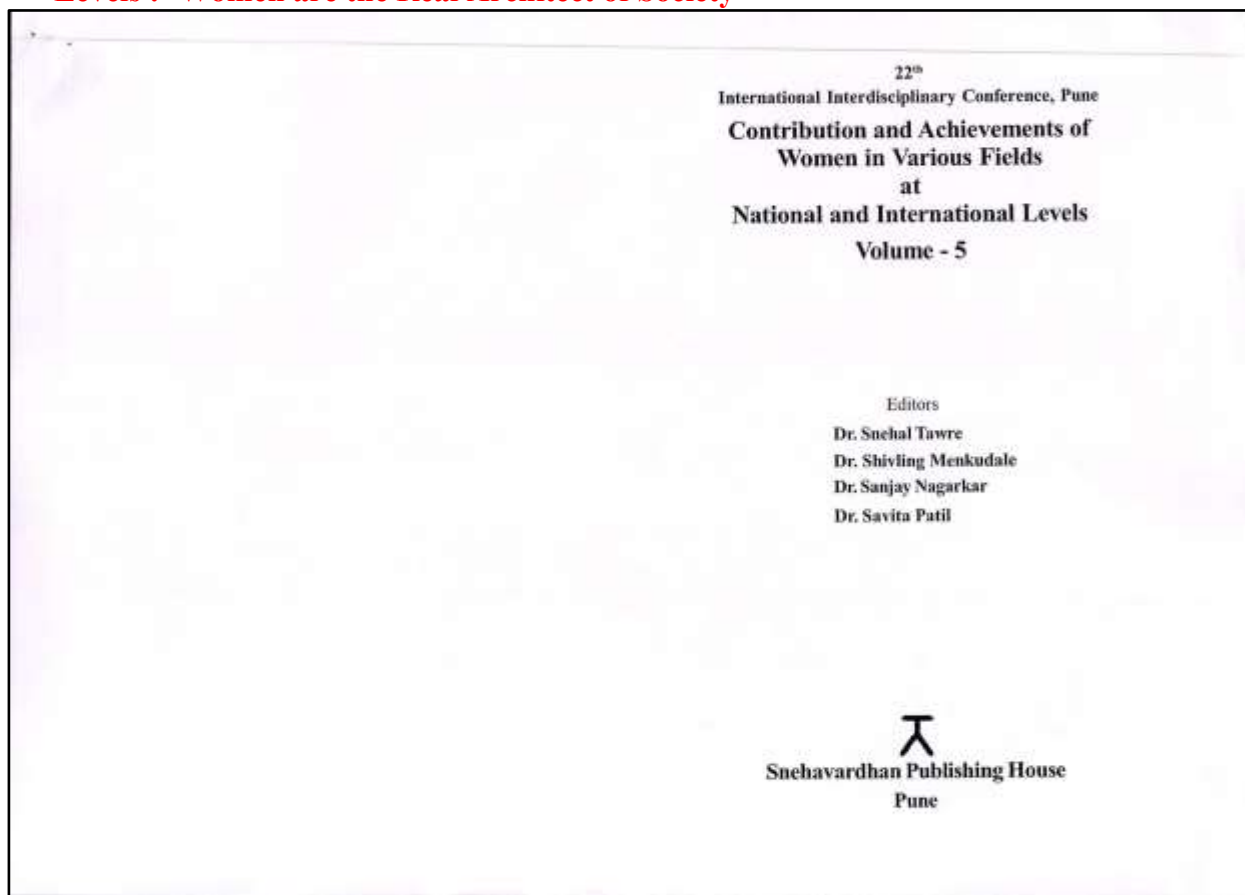

Index

Volume -5

- Editorial - Dr. Snehal Tawre
- Dr. Shivling Menkundale
- Dr. Sanjay Nagarkar
- Dr. Savita Patil ..9
- 1. Indra Nooyi, former - Dr. Dhnanjay Keskar ..13
CEO of Pepsico (Mauritius)
- 2. Sister Nivedita's - Dr. Rewant Singh ..18
Contributions towards (Shri Lanka)
Women's Education in India
- 3. The Home Maker - Col. Anand ..23
My Wife : Joyti
- 4. Sudha Murthy : - Dr. Sujata Keskar ..28
Chairperson of Infosys (Mauritius)
Foundation
- 5. The Great wife of the - Lyudmila Sekacheva ..32
Great Gandhi (Moscow, Russia)
- Anastasia Ilyushina
(Moscow, Russia)
- 6. Contribution and - Dr. Namdev Patil ..36
Achievements of Indian Women Writers in English
- 7. The Role of Women in - Dr. Sonu Lande ..40
the field of Farmess, Educators and Entrepreneurs
- 8. Contribution of Annie - Dr. Rajendra Raskar ..45
Besant in Indian History

- 9. Role and Contributions - Dr. Devaki Rathod ..49
of Women Entrepreneurs in India
- 10. Women's Contributions - Dr. Bobade Manjushri ..54
in Indian Banking Sector : Problems
and Challenges
- 11. No Pain, No Gain : - Dr. Sangita Ghodake ..59
Critiquing the Selected Nobel Laureate Women
From Asia, Africa and America
- 12. The Matrix of Body in - Dr. Chandra Rajhans ..64
Mahasweta Devi's Selected Short Stories
- 13. Simon-de-Beauvoir: - Dr. Savita Patil ..69
A Pioneer of Feminism
- 14. Anita Desai's Cry, The - Dr. Sheelu Sengar ..73
Peacock : A Portrayal of Emotional Alienation
- 15. Nobel Prize Winner - Dr. Mohan Kamble ..78
(2019) Esther Duflo Contribution in Economics
- 16. Literary Feminism in Sara - Prof. Jaysbri Patil ..83
Jeannette Duncan's - Dr. Tejaswini Patil Dange
Novel, A Daughter of To-Day
- 17. The Poetry of Body and - Dr. Alka Rani Purwar ..88
Soul in the Short Stories of Ismat Chughtai
- 18. Joan Robason - Dr. Sudam Bhujbal ..93
- 19. Contribution of - Dr. Nilima Tidke ..97
Sudha Murthy in English Literature
- 20. Amrita Pritam as a - Dr. Reshanara Shaikh ..102
Versatile Writer and Predicament of Puro in her
novel 'Pigjar'
- 21. Sindhatai Sapkal as a - Dr. Shahaji Karande ..107
Social Reformer
- 22. Dr. Indira Hinchaji's - Dr. Sushama Pawar ..111
Contribution and - Dr. Hemalata Karkar
Achievements in Medical Science in India
- 23. Pandita Ramabai : - Dr. Nandkumar Jadhav ..115
A Champion of Women's Right
- 24. World's First Female - Dr. Mohan Chougule ..120
Prime Minister : Sirimavo Bandaranaike
- 25. Contribution of Women - Dr. Tanu Sharma ..125
Psychologist in the Past and Present Scenario
- 26. Role of Women in Indian - Dr. Stuti Bhrigu ..130
Economic Development: Problems and Prospects
- 27. Contributions and - Dr. Lodhi Fatma ..135
Achievements of Women Niyaz Ahmed
as a Social Reformers
- 28. Social and Political - Dr. Salma Ab. Sattar ..140
Participation of Women
- 29. Gender Equality in - Dr. Shikha Joyti Deka ..145
Employment: A Global Perspective
- 30. Achievements of - Dr. Udaykumar Sangale ..150
Women in Various Fields
- 31. Women are the Real - Prof. Sandip Thombare ..155
Architects of Society
- 32. Tessy Thomas : - Prof. Vishal S. Shishupal ..160
Missile Woman of India
- 33. Pandita Ramabai's - Dr. Manjiri Karekar ..165
Conversion and her role in the
Social-Political life : A Review

thousand hours of flying an aircraft and became the first woman pilot to obtain 'A' license. She also achieved the title of the first Indian to get airmail pilot's license.

Mary Kom :

Mary Kom Mangte Chungesejang Mary Kom, also known as Mary Kom is the only woman boxer who has won a medal in each of the six World Championships. She was the only Indian woman boxer who qualified for the 2012 Olympics and became the first Indian woman boxer to win a gold medal in Asian Games in 2014.

Bachendri Pal :

Bachendri Pal became the first Indian woman to reach the summit of Mount Everest in 1984. Later, she led expeditions in 1993, 1994 and 1997 with a team comprising of only women in 'Indo-Nepalese Women's Mount Everest Expedition', 'The Great Indian Women's Rafting Voyage' and 'First Indian Women Trans-Himalayan Expedition.'

Durga Banerjee :

Durga Banerjee was the first Indian female pilot and captain of Indian Airlines in the year 1966. She was also the first woman ever to fly the 'Toendo A-200' aircraft.

Priya Jhingan :

Priya Jhingan with a dream to be serve Indian Army, became the first lady cadet to join the Indian Army in 1993.

Reference :

1. Lean In : Women, Work, and Will to Lead by Sheryl Sandberg published 2013
2. The Moment of Lift: How Empowering Women Changes the World by Melinda Gates published 2018
3. Empire of Storms by Sarah J. Mass published 2016
4. The Bell Jar by Sylvia Plath published 1963
5. Website - www.gongki.com women in India.

Contribution and Achievements of Women in Various Fields 154

Women are the Real Architects of Society

- Prof. Sandip Ashok Thombare

Introduction :

"You can tell the condition of a nation by looking at the status of its women" This is a famous quote by Jawaharlal Nehru on women. The status of women depicts the social, economic and mental condition in a nation. Women have been regarded as a symbol of spirituality in our scriptures. Women are important in our society. Every woman has her own job or duty in this modern society in which men are still the 'strongest gender'. We can't forget that women's life is a lot more complicated than a man's life. A woman has to take care of her own personal life and if she is a mother, she has to take care also about her children's life too. The spread of education and self-consciousness among women has led to their progress over the period. Women of today are empowered. Also, women are gaining advancements and success in each and every field.

Before knowing the Contribution of women first remember the woman with simple poem.....

Remember woman, you were born life giver, miracle creator, magic maker.

You were born with the heart of a thousand mothers, open & Fearless and sweet.

You were born with the fire of queens & Conquerors, warrior's blood you bleed.

You were born with wisdom of sages and shamans, no wound can you not heal.

You were born the teller of your own tale, before none

Women are the Real Architects of Society 155

you should kneel.

You were born with an immeasurable soul reaching out past infinite.

You were born to desire with passion abandon & to name your own destiny.

Remember woman remember you are more than you can see.

Remember women remember your power and grace the depth of your deep sea heart.

In the Indian Independence movement women lead from the front and emerged as game changers in the quest for independence. Before 1857, women leaders made a significant mark of their valor and will as early as in 18th century and set the stage for emphasizing that women were in no way willing to be relegated to the backdrop of freedom struggle. Maharani Veli Nachiyar (1732-1796) bravely fought with British army decades before 1857 revolt she probably remains the only queen to have defeated the British army successfully. The 1857 Revolt saw many stalwart women participants in the freedom struggle that have gone down as legends in the history of Indian independence. Rani Lakshmbai, dressed up as a man and fought alongside her battalion bravely against the British army. Begum Hazrat Mahal, refused to be bogged down by the doctrine of lapse and reclaimed Awadh from British. sarojini Naidu, also commonly known as the nightingale of India was prolific writer and poet. she was president of the Indian National Congress and was an outstanding leader campaigning and leading from the front in the civil disobedience movement & salt satyagraha. Savitribai Phule (1831-1897) she is regarded as first female teacher of India. she is regarded as the mother of Indian feminism. she founded first Indian girls school in Pune. She worked to abolish the discrimination and unfair treatment of people based on caste and gender. these are some examples of women who fought against British.

A new dimension of women in politics emerged in recent

Contribution and Achievements of Women in Various Fields 156

years all over the world more and more women have now been entering into politics. it is heartening to note that Indian women were among the earliest to get their political rights without any political movement like in the United States & many Western countries. Indian women have distinction to become UNO Secretary (Vijaya Lakshmi Pandit) Prime Minister (Indira Gandhi), chief minister as Sucheta Kriplani, Jayalita Uma Bharti, Mayawati and Vasundhara Raje etc. The youngest prime minister in the world is also a woman. Sanna Marin is a finished politician the PM of Finland.

In the era of globalisation women play a crucial role in the development but they have been largely ignored. much of women's work remain unrecognized, uncounted and unpaid in the home, in agriculture, in food production, in childcare. In the last decade all over the world including India, women have participated in development process on a wider scale than ever before, even if only at small scale level. for eg. they have been main actors in micro credit scheme all over the world, they run their businesses. eg. of women cooperative society in Gujarat which prepares a well known brand of Papad 'Lijjat'. A recent Wealth Management study says that by 2020 women millionaires would outnumber their male counterparts and that within 20 years 60% of the world wealth would be managed by women. In so many companies the person at the top is now women for eg. Indra Nooyi (PepsiCo), Kiran Mazumdar-shaw of (biocoin) and former head of CICI Bank Chanda Kochhar. In the 21st century 'Environment & climate change' is become the major issue. Women play a critical role in managing natural resources on family and community level and are most affected by environmental degradation 'women produce 60 to 80% of a food in developing countries' while inheritance laws and local custom often prevent them from owning or leasing land. from the high level to grassroots the 1992 UN Earth summit, India's Chipko Movement, Kenya Green Belt movement. All highlighted the role of women's voices and perspectives in sustainable development.

Women are the Real Architects of Society 157

Now we will see the women who fought to bring change with their social work. Mother Teresa regarded as a symbol of love and humanity throughout the world. she was survivor of thousands of orphans and deserted children's. she devoted her entire life serving the ill and miserable people. Aruna Roy known for her efforts to fight corruption and promote government transparency. Roy entered in civil service in 1968 as an IAS, she left the IAS in 1974. In 1990 she setup Mazdoor Kisan Shakti Sangathan(MKSS) Organisation. Devoted to empowering workers. A nation wide grassroots campaign launch by MKSS led to adoption of (RTI) Right to Information. let's see the wonderful achievements and contribution of women in science. Aditi Pant is an oceanographer and first Indian woman to travel to antarctica as a part of the 1983 Indian expedition. she has conducted coastal studies and has travelled the entire Indian West coast. Nandini Harinath a rocket scientist at the Indian Space Research Organisation (ISRO). Nandani has worked on 14 missions in her 20 years of work. she was the deputy operation director for the Mangalyaan mission. Women's are not lagging in sports also let's see some International sport personalities. Sania Mirza (world's number one woman double tennis player) , Saina Nehwal (world's number 1 badminton player) Mary Kom (Worlds best boxing player) & many more. In spite of many gains much remains to be done to improve the status of women in India. The female work participation rate in India is only 26% where as it is 46% in China. According to 2011 census 34 out of 100 women are illiterate in India Where as only 13 in China. former UN Secretary General Kofi Annan once remarked "Study after study has shown that there is no effective development strategy in which women does not play a central role. when women are fully involved the benefits can be seen immediately, families are healthier & better fed; their income, savings go up and what is true of families is also true of communities and in the long run of whole countries".

Contribution and Achievements of Women in Various Fields ❧ 158

Conclusion :

There has been a steady transformation in the status of the women in comparison to earlier periods. Women of today take part completely in areas such as politics, status, military sectors, economic, service, and technology sectors at national & international level. Moreover, they have contributed wholly in sports too. Thus, they have occupied a dignified position in family and society. a women's role has changed tremendously and is making its greatest impact in our society today.

❧❧❧

References

- 1) Betty Friedan's book 'The Feminist Mystique'
- 2) Making a Difference Memoirs from the Women's Movement in India by Ritu Menon
- 3) No One Is Too Small to Make a Difference by Greta Thunberg
- 4) Sociology of Gender: The Challenge of Feminist Sociological Thought by Sharmila Rege
- 5) Census of India. 2011 <http://www.imaginor.com/census-of-india-2011.html>
- 6) Bumiller E. New Delhi: Penguin Books; 1991. May You Be the Mother of a Hundred Sons: A Journey among the Women of India
- 7) Empowerment of Women in India by Karne Padmavathi
- 8) Great Women of India Blusli K.S.

Women are the Real Architects of Society ❧❧❧ 159

33. Challenges before Service Sector in India

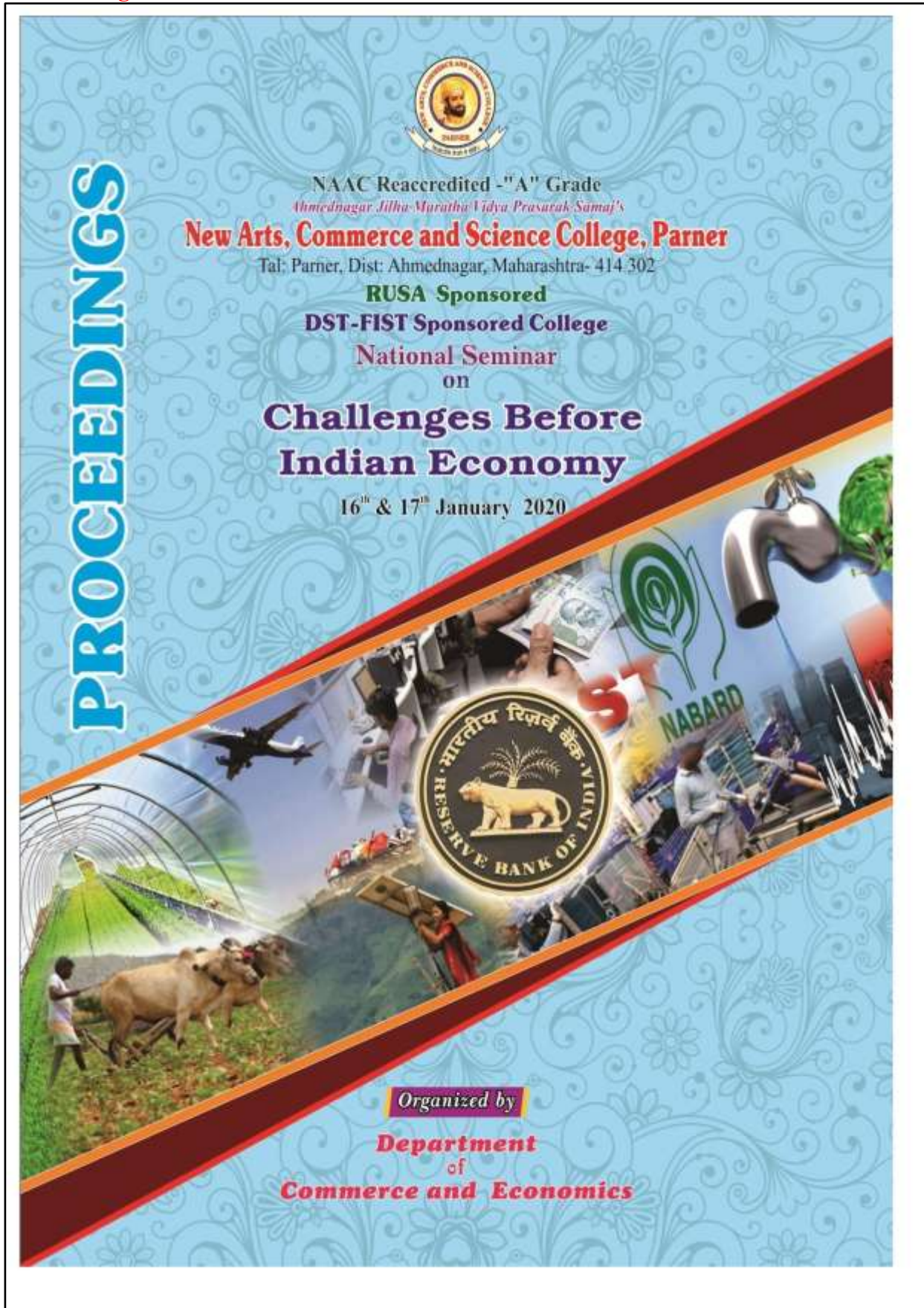

Contents

Sr. No.	Name Of Researchers	Title Of Research Paper	Page No
1.	Agrarian Distress In Indian Agriculture :Emerging Challenges And Policy Implementation	Dr. Bhausaheb .Y. Deshmukh	01
2.	Challenges Before Indian Economy	Prof. Darekar B.P.	10
3.	Problems & Prospects Of Agrobased Industries In Economical Development Of India –A Study	Thorat Rahul Dagadu (Research Scholar) Dr. Mote D.K. (Associate Professor)	14
4.	विक्रम - 'कृषि विकास' योजना	कृषि विकास -	18
5.	Waiving Farm Loans Is Not Only Bad For The Economy But Also Detrimental To Interests Of The Farmer	Prof. Amita Bhushan Bhalerao	21
6.	Positive And Negative Impact Of GST On The Indian Economy	Asst. Prof. Datir K.R.	24
7.	Impact Of GST On Indian Economy	Mr.Galbote Tushar Ambadas	28
8.	Indian Rural Development : Issues And Challenges	Dr. Govind S Deshmukh	33
9.	Role Of RBI, NABARD In Indian Economy	Prof. Pingat Savita Pandurang	37
10.	Challenges Before Service Sector In India	Dr. Sudhir R. Wagh (Head, Department Of Zoology) Mr. Yuvaraj M. Waghare (Head, Department Of Commerce)	42
11	Impact On GST On Indian Economy	Prof.Mohalkar S.D.	46
12	Emerging Trends In Marketing	Prof. Sushil D. Pawar	49
13	Agriculture Sector In India	Mr. Shivaji Rangnath Pathare	54
14	Impact Of GST On Indian Economy	Prof. Shinde M.D	58
15	Challenges Before Agricultural Sector In India	Dr. Sunita Sadashiv Thube	64
16	Impact Of Inflation On Indian Economy	Prof. Kale Sachin Vijay (M.A.,M.Phil,SET)	71
17	Importance Of Service Sector In India	Dr.B.P.Thakur (M.A.M.Phil.Ph.D)	74
18	Impact Of GST On Indian Economy	Dr.Salve Dharmendra Bhagwan	78

RUSA, DST, FIST sponsored National Seminar on "Challenges before Indian Economy".

By Department of Commerce and Economics, N.A.C.& S. College, Parner, Dist- Ahmednagar (M.S.)

Challenges before Service Sector in India

Dr. Sudhir R. Wagh (Head, Department of Zoology)

New Arts, Com. and Sci. College, Parner, Email ID : srwagh@rediffmail.com

Mr. Yuvaraj M. Waghere(Head, Department of Commerce)

New Arts, Com. and Sci. College, Parner, Email ID : yuvaraj.waghere@gmail.com

Abstract :

This paper provides an overview of the Indian services sector. It shows that services is the fastest growing sector in India, contributing significantly to gross domestic product (GDP), GDP growth, employment, trade, and investment. India is a major proponent of liberalizing services both in the World Trade Organization and in its bilateral trade agreements. However, there are some concerns. In the recent past, economic growth and growth of the services sector has slowed down. Growth in employment in services has not been commensurate with the share of the sector in GDP. Although India is a major exporter of services, its export competitiveness concentrates in few sectors and a few markets. Service sector also known as tertiary sector is essential for economic growth in any economy including India. It has emerged as the biggest and fastest-growing sector in the global economy in the last two decades. This sector continues to live a star performer and by contributing significantly to GDP, GDP growth, employment, trade and investment. A large part of the employment is in the non-corporate or unorganised sector, with limited job security.

Keywords : *employment, service, GDP, service sector, economic growth, industry*

Introduction :

Though service growth has long been recognised, the literature has not yet produced an account of the nature of services or of the determinants of their growth that commands widespread support. This is not simply a matter of producing an elegant definition, or formal model of growth, or of deciding which school of thought to follow. It is common for different standpoints to exist, as in economic theory or in management theory, for example. An orderly and effective policy development at government, industry or company level depends on taking a well-grounded view of several issues that recur in the literature, but so far without resolution. Consistent resolution of the issues is more likely to occur if the current fragmented knowledge is supplemented by co-ordinated and probably comparative research programmes. It is possible to make inroads into the issues, in the absence of such research, by means of analysis of some of the recurrent themes. The

10 | Page

RUSA, DST, FIST sponsored National Seminar on "Challenges before Indian Economy".

By Department of Commerce and Economics, N.A.C.& S. College, Parner, Dist- Ahmednagar (M.S.)

issues identified are: (i) the nature of services, as opposed to manufactures; (ii) the causes or determinants of service growth; (iii) the inter-relationships between services and the rest of the economy; (iv) the prospects for service growth in terms of both employment and income; (v) the 'trade ability of services' and (vi) the main policy implications for government and industry. It is concluded that there are no compelling reasons for believing that services cannot take up shortfalls in employment and income due to manufacturing decline (or cyclical behaviour). Nor is there any reason to believe that they will do so, given present policies and states of knowledge.

Service sector also known as tertiary or residual sector is essential for economic growth in any economy including India. It has emerged as the largest and fastest-growing sector in the global economy in the last two decades. On the basis of this observed development pattern of countries some economists like Fisher (1939) Clark (1940) Rostov (1960) and Kuznets (1971) have suggested that development is a three stage process. The dominance of the services sector in the growth process is associated with the third stage of development. However in India the acceleration in growth in recent years has been due to the dynamism of the service sector while the contribution of industry has tended to stagnate over the last two decades. Service now contributes almost 59% to India's GDP and have contribution to more than 60% of India's growth during the period of the last decade and a half. Firstly, Fisher classified the economy into primary, secondary and tertiary sector. Later on Kuznets introduced the term 'services' instead of tertiary, there by bringing the sector into economic discussion (Kuznets, 1972).

The objective of this paper is to provide an overview of the Indian services sector as follows:

1. Growth of service sector in India, its share in GDP and its contribution to GDP growth
2. Share of service in employment
3. Concludes the study with policy implications.

Sectoral Growth Rate:

The Indian economy has grown at a robust rate during the few years and a striking feature of this growth performance has been the strength of the service sector. Table first shows that on average service grew slower than industry between 1950 and 1990, growth of service picked up in the 1980s, and accelerated in the 1990s when it averaged 7.5% per annum, thus providing a valuable prop to industry and agriculture, which grew on average by 5.8% and 3.1% respectively. The slowdown in the Ninth plan (1997-2002) was confined to agriculture and industry with the services registering a remarkable rate of growth of 7.9% per annum. The expansion of services accelerated further in the years after 2002-03. over the Tenth year plan period (2002-07), services grew at a rate of 9.3% per annum and Eleventh year plan period (2007-12), services grew at a

RUSA, DST, FIST sponsored National Seminar on “Challenges before Indian Economy”.

By Department of Commerce and Economics, N.A.C.& S. College, Parner, Dist- Ahmednagar (M.S.)

rate of 9.7% per annum. Table 1 and above discussion clearly brings out the fact that what the Indian economy has witnessed in recent period is a services led growth.

Contribution of the Services Sector to India's GDP:

After India's independence, for more than a decade share of services in the GDP was less than 30%. Table 2 shows that overtime the share of services in GDP has increased while that of agriculture has declined. In the last decade, the share of services has surpassed the combined share of agriculture and industry, making it the most important provider to the country's output. In 2009-10, services, industries and agriculture correspondingly accounted for 57.3%, 25.7% and 16.9% of India's GDP. In 2010-11, service, industry and agriculture correspondingly accounted for 57.7%, 27.8%, and 14.5% of India's GDP. In 2011-12, service, industry and agriculture correspondingly accounted for 59%, 27%, and 13.9% of India's GDP. During the period of economic reforms the share of service has increased very rapidly.

Employment in The Services Sector:

There has been a lot of debate on employment generating capacity of services sector. It has been argued that employment growth in services sector has not be commensurate to the income growth in the sector (Bosworth and Maertens, 2010) or the increase in its share in India's GDP (Koche et. al. 2006). The change in the production structure from agriculture to services has not be reflected by a proportionate change in the occupational structure (Bhattacharya and Mitra 1990). As a result, services-led growth has be a jobless growth (Banga, 2005 and Bhattacharya and Sakthivel 2004). Over the years, the percentage of people employed in agriculture has declined and employment in services has increased, though the broad pattern of employment has remained the same with agriculture having the highest share. Table 4 explores that percentage share of services sector in total employment is increasing since 1972-73. Though the employment percentage in agriculture sector is highest in comparison of other sectors yet its share is declining continuously. However, the services sector is the second largest employer after agriculture for Indian population.

Conclusions:

From the above information it can be noted that, in comparison with other sectors there is a significant growth rate in service sector. The growth rate is higher than the overall GDP. It tends to cover the overall agricultural sectors poor performance. Service sectors employment percentage is increasing whereas; there is a decrease in agriculture sector. Most of the Indian population is engaged in the agriculture sector and it can also be seen that the other largest

RUSA, DST, FIST sponsored National Seminar on "Challenges before Indian Economy".

By Department of Commerce and Economics, N.A.C.& S. College, Parner, Dist- Ahmednagar (M.S.)

employer is the service sector like social services, hotels and restaurants, trade and industry etc.
Service sector serves as an engine of growth in the economy.

References :

1. <https://www.tandfonline.com/doi/abs/10.1080/15387216.2016.1151371>
2. <https://www.tandfonline.com/doi/pdf/10.1080/02642068800000065?needAccess=true>
3. <https://www.ijraset.com/fileserve.php?FID=2349>
4. <https://pdfs.semanticscholar.org/6c2b/270fcd33d9cf6d161965813905416cfeae79.pdf>
5. Government of India (2010-11, 2011-12 & 2012-13), 'Economic Survey of India'
6. Misra S.K,Puri V.K Himalaya Publishing House
7. Joshi, S. (2008), 'Growth and Structure of Tertiary Sector'. New Delhi: Academic Foundation

34. Agriculture Sector in India

The cover features a blue background with a floral pattern. At the top center is the college's logo. Below it, the text reads: 'NAAC Reaccredited - "A" Grade', 'Ahmednagar, Jilha-Murutha-Vidya-Prasarak-Samaj's', 'New Arts, Commerce and Science College, Parner', and 'Tal: Parner, Dist: Ahmednagar, Maharashtra- 414.302'. The seminar is 'RUSA Sponsored' and 'DST-FIST Sponsored College'. The title is 'National Seminar on Challenges Before Indian Economy', dated '16th & 17th January 2020'. A large diagonal collage shows a greenhouse, a farmer with oxen, a hand holding a coin, a water tap, a city skyline, and the Reserve Bank of India logo. The word 'PROCEEDINGS' is written vertically on the left. At the bottom, it says 'Organized by Department of Commerce and Economics'.

PROCEEDINGS

NAAC Reaccredited - "A" Grade
Ahmednagar, Jilha-Murutha-Vidya-Prasarak-Samaj's
New Arts, Commerce and Science College, Parner
Tal: Parner, Dist: Ahmednagar, Maharashtra- 414.302

RUSA Sponsored
DST-FIST Sponsored College
National Seminar
on
**Challenges Before
Indian Economy**
16th & 17th January 2020

Organized by
**Department
of
Commerce and Economics**

Contents

Sr. No.	Name Of Researchers	Title Of Research Paper	Page No
1.	Agrarian Distress In Indian Agriculture :Emerging Challenges And Policy Implementation	Dr. Bhausaheb .Y. Deshmukh	01
2.	Challenges Before Indian Economy	Prof. Darekar B.P.	10
3.	Problems & Prospects Of Agrobased Industries In Economical Development Of India –A Study	Thorat Rahul Dagadu (Research Scholar) Dr. Mote D.K. (Associate Professor)	14
4.	विक्रम - 'कृषि क्षेत्रों में विकास' का विकास	कृषि क्षेत्रों में विकास	18
5.	Waiving Farm Loans Is Not Only Bad For The Economy But Also Detrimental To Interests Of The Farmer	Prof. Amita Bhushan Bhalerao	21
6.	Positive And Negative Impact Of GST On The Indian Economy	Asst. Prof. Datir K.R.	24
7.	Impact Of GST On Indian Economy	Mr.Galbote Tushar Ambadas	28
8.	Indian Rural Development : Issues And Challenges	Dr. Govind S Deshmukh	33
9.	Role Of RBI, NABARD In Indian Economy	Prof. Pingat Savita Pandurang	37
10.	Challenges Before Service Sector In India	Dr. Sudhir R. Wagh (Head, Department Of Zoology) Mr. Yuvaraj M. Waghare (Head, Department Of Commerce)	42
11	Impact On GST On Indian Economy	Prof.Mohalkar S.D.	46
12	Emerging Trends In Marketing	Prof. Sushil D. Pawar	49
13	Agriculture Sector In India	Mr. Shivaji Rangnath Pathare	54
14	Impact Of GST On Indian Economy	Prof. Shinde M.D	58
15	Challenges Before Agricultural Sector In India	Dr. Sunita Sadashiv Thube	64
16	Impact Of Inflation On Indian Economy	Prof. Kale Sachin Vijay (M.A.,M.Phil,SET)	71
17	Importance Of Service Sector In India	Dr.B.P.Thakur (M.A.M.Phil.Ph.D)	74
18	Impact Of GST On Indian Economy	Dr.Salve Dharmendra Bhagwan	78

RUSA, DST, FIST sponsored National Seminar on "Challenges before Indian Economy".

By Department of Commerce and Economics, N.A.C.& S. College, Parner, Dist- Ahmednagar (M.S.)

Agriculture Sector in India

Mr. Shivaji Rangnath Pathare

Dept. of Commerce, New Arts, Commerce & Science College, Parner.

Shivajipathare88@gmail.com

Introduction:

Agriculture sector of India has occupied almost 43 percent of India's geographical area. Agriculture is still the only largest contributor to India's GDP even after a decline in the same in the agriculture share of India. Agriculture also plays a significant role in the growth of socio-economic sector in India.

In the earlier times, India was largely dependent upon food imports but the successive stories of the agriculture sector of Indian economy has made it self-sufficing in grain production. The country also has substantial reserves for the same. India depends heavily on the agriculture sector, especially on the food production unit after the 1960 crisis in food sector. Since then, India has put a lot of effort to be self-sufficient in the food production and this endeavor of India has led to the Green Revolution. The Green Revolution came into existence with the aim to improve the agriculture in India.

Objective:

Present study is undertaken for finding out the different challenges before Indian agriculture sector.

Methodology:

Present study is based on secondary data, which is collected from different secondary sources. Eg. Books, periodicals, journal and newspaper etc.

Findings:

While agriculture's share in India's economy has progressively declined to less than 15% due to the high growth rates of the industrial and services sectors, the sector's importance in India's economic and social fabric goes well beyond this indicator. First, nearly three-quarters of India's families depend on rural incomes. Second, the majority of India's poor (some 770 million people or about 70 percent) are found in rural areas. And third, India's food security depends on producing cereal crops, as well as increasing its production of fruits, vegetables and milk to meet

RUSA, DST, FIST sponsored National Seminar on “Challenges before Indian Economy”.

By Department of Commerce and Economics, N.A.C.& S. College, Parner, Dist- Ahmednagar (M.S.)

the demands of a growing population with rising incomes. To do so, a productive, competitive, diversified and sustainable agricultural sector will need to emerge at an accelerated pace.

India is a global agricultural powerhouse. It is the world's largest producer of milk, pulses, and spices, and has the world's largest cattle herd (buffaloes), as well as the largest area under wheat, rice and cotton. It is the second largest producer of rice, wheat, cotton, sugarcane, farmed fish, sheep & goat meat, fruit, vegetables and tea. The country has some 195 m ha under cultivation of which some 63 percent are rainfed (roughly 125m ha) while 37 percent are irrigated (70m ha). In addition, forests cover some 65m ha of India's land.

Challenges before Agriculture Sector:

Following are challenges before Indian agriculture sector, which are observed during present study:

1. Low Irrigation Facilities:

India is the second largest irrigated country in the world after China. Irrigation is the most important agricultural input in a tropical monsoon country like India where rainfall is uncertain, unreliable and erratic India cannot achieve sustained progress in agriculture unless and until more than half of the cropped area is brought under assured irrigation.

This is testified by the success story of agricultural progress in Punjab Haryana and western part of Uttar Pradesh where over half of the cropped area is under irrigation! Large tracts still await irrigation to boost the agricultural output

2. Soil erosion:

Soil erosion in India is widespread and a serious threat to survival and well-being. It occurs in forest lands, arid and semi arid lands, agricultural lands, construction sites, roadways, disturbed lands, surface mines, glaciated and coastal areas and in areas where natural or geologic disturbances take place.

3. Ownership Pattern:

Ownership of agricultural land in India is fairly widely distributed, there is some degree of concentration of land holding. Inequality in land distribution is also due to the fact that there are frequent changes in land ownership in India. It is believed that large parcels of land in India are owned by a- relatively small section of the rich farmers, landlords and money-lenders, while the vast majority of farmers own very little amount of land, or no land at all.

4. Subdivision of Land Holding:

Due to the growth of population and breakdown of the joint family system, there has occurred continuous sub-division of agricultural land into smaller and smaller plots. At times

RUSA, DST, FIST sponsored National Seminar on "Challenges before Indian Economy".

By Department of Commerce and Economics, N.A.C.& S. College, Parner, Dist- Ahmednagar (M.S.)

small farmers are forced to sell a portion of their land to repay their debt. This creates further sub-division of land.

5. Traditional Cropping Pattern:

As mentioned before, India produces rice and wheat in abundance. Some regions can easily adapt to facilitate the growth of new crops that can yield a higher quantity of produce. Farmers are resistant or hesitant to give it a try. Endorsing associations of commodity-based farmers and spreading awareness is a very effective way to overcome the over-dependence on traditional crops. The seed banks are playing a crucial role in helping farmers switch to other varieties of crops to facilitate a smooth transition.

6. Lack of Storage Facilities

The lack of proper storage facilities results in degradation of the quality of the produce. This, in turn, affects the volume of exports causing loss of potential income. Not to mention wastage of the produce. Estimates say that 9.3% of the produce gets wasted because of improper storage and maintenance.

7. Traditional Technology:

In spite of the advancement in agriculture, most of the farmers are using the conventional tools for ploughing, sowing, irrigating, thinning and harvesting. Marginal and small farmers are using much of the human labour, which results in the wastage of human labour and in low yields per capita labour force. However some progress has been made in this direction after independence. Green revolution which started in 1966-67, made some impact on the technology used in the agriculture.

8. Agro Marketing:

Agriculture marketing is still a huge concern in the rural areas. In the absence of proper marketing facilities, the farmers are dependent on local traders and middlemen for the disposal of their agriculture produce which is sold at throw away price. In small villages farmers sell their produce to the money lender under socio-economic conditions.

9. Inadequate Capital;

The role of capital is becoming more and more important with the advancement in the agricultural technology. Since agriculturists' capital is locked up in the land of the farmers, he is bound to borrow money. The main suppliers of money to farmers are the money lenders, traders and commission agents who charges high rate of interest and purchase the agricultural produce of farmers at very low price.

RUSA, DST, FIST sponsored National Seminar on “Challenges before Indian Economy”.

By Department of Commerce and Economics, N.A.C.& S. College, Parner, Dist- Ahmednagar (M.S.)

Reference:

1. Books on 'Indian Agriculture'- by Dr. Anirudh Kumar
2. Books on 'Agriculture Problems of India'- by Dr. Badri Bishal Tripathi

35. Challenges before the skill development in India

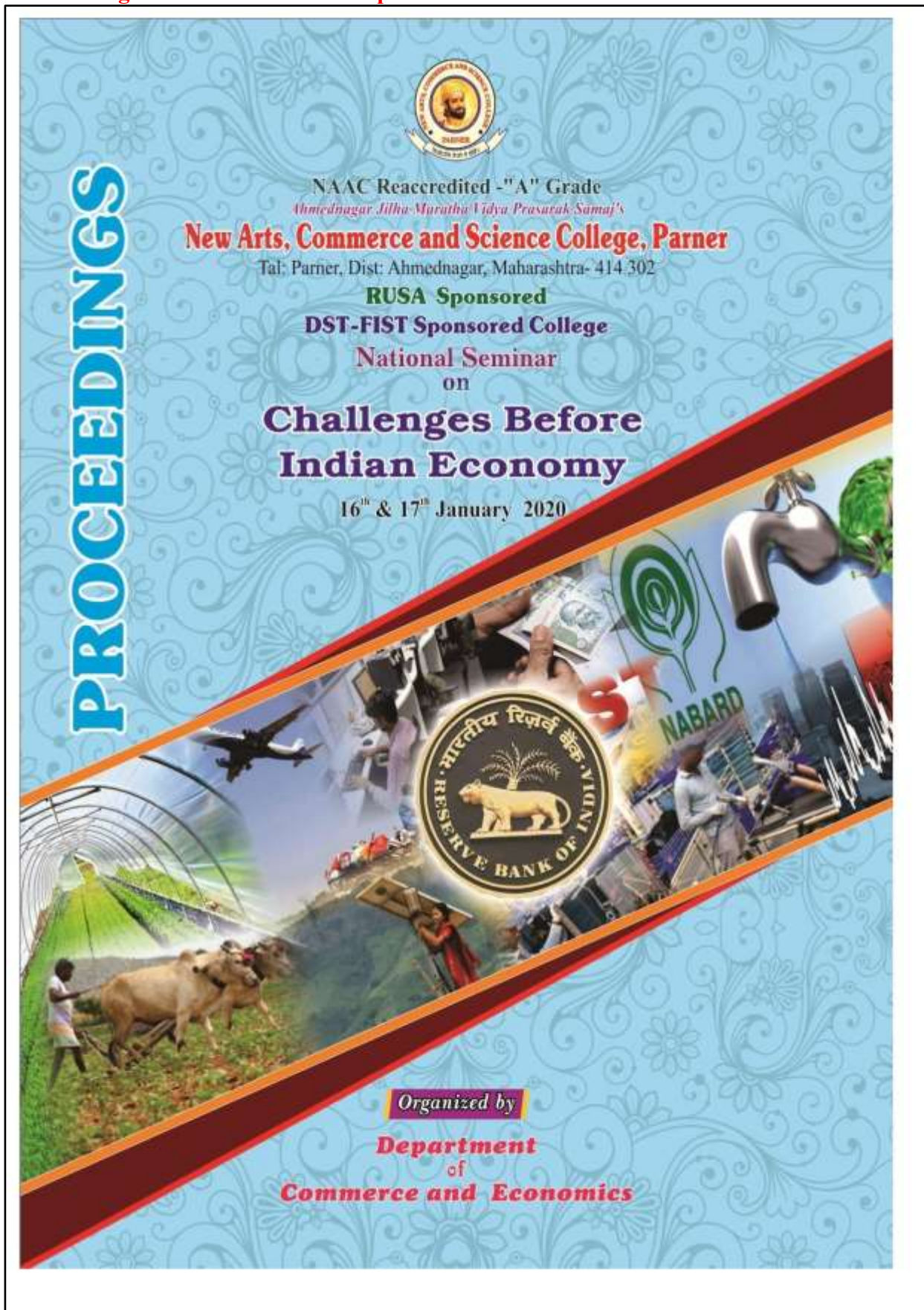

Contents

Sr. No.	Name Of Researchers	Title Of Research Paper	Page No
1.	Agrarian Distress In Indian Agriculture :Emerging Challenges And Policy Implementation	Dr. Bhausaheb .Y. Deshmukh	01
2.	Challenges Before Indian Economy	Prof. Darekar B.P.	10
3.	Problems & Prospects Of Agrobased Industries In Economical Development Of India –A Study	Thorat Rahul Dagadu (Research Scholar) Dr. Mote D.K. (Associate Professor)	14
4.	विक्रम - 'कृषि विकास' योजना	कृषि विकास -	18
5.	Waiving Farm Loans Is Not Only Bad For The Economy But Also Detrimental To Interests Of The Farmer	Prof. Amita Bhushan Bhalerao	21
6.	Positive And Negative Impact Of GST On The Indian Economy	Asst. Prof. Datir K.R.	24
7.	Impact Of GST On Indian Economy	Mr.Galbote Tushar Ambadas	28
8.	Indian Rural Development : Issues And Challenges	Dr. Govind S Deshmukh	33
9.	Role Of RBI, NABARD In Indian Economy	Prof. Pingat Savita Pandurang	37
10.	Challenges Before Service Sector In India	Dr. Sudhir R. Wagh (Head, Department Of Zoology) Mr. Yuvaraj M. Waghare (Head, Department Of Commerce)	42
11	Impact On GST On Indian Economy	Prof.Mohalkar S.D.	46
12	Emerging Trends In Marketing	Prof. Sushil D. Pawar	49
13	Agriculture Sector In India	Mr. Shivaji Rangnath Pathare	54
14	Impact Of GST On Indian Economy	Prof. Shinde M.D	58
15	Challenges Before Agricultural Sector In India	Dr. Sunita Sadashiv Thube	64
16	Impact Of Inflation On Indian Economy	Prof. Kale Sachin Vijay (M.A.,M.Phil,SET)	71
17	Importance Of Service Sector In India	Dr.B.P.Thakur (M.A.M.Phil.Ph.D)	74
18	Impact Of GST On Indian Economy	Dr.Salve Dharmendra Bhagwan	78

19	Impact Of New FDI In E-Commerce Rules In India On Customers	. Nikhil Bharat Goyal (M.Com., FCA, NET, SET)	80
20	Impact Of GST On Indian Economy	Thube Pranita Santosh	83
21	Role Of Banking System In The Economic Growth And Development	Dr. S. R. Bakhale Prof. S. S. Thorat	87
22	Introduction To Indian Economy And Problems Faced By It	Prof. Ranjit A. Shinde	93
23	Demonetization And Its Effect On Indian Economy	Mr. Satbhai Abhijit Prakash	99
24	Role Of RBI, Nabard In Indian Economy RBI	Mr. Surendra Laxmanrao Bhujbal	106
25	Indian Economy And Rural Development	Dr. Bhandari Mousmi Jitendra	112
26	Challenges Before The Skill Development In India	Bhushan D. Bhalerao	114
27	Impact Of GST On Indian Economy	Dr. Karuna B. Kamble	119
28	Important Challenges And Prosperous Of Indian Economy: Reference To Agriculture Sector	Dr. K.M.Tele	122
29	Impact Of GST On Indian Economy	Dr.Karuna B. Kamble	126
30	Economical Challenges In Front Of Indian Government & It's Solutions	Prof. Thombare Sandip Ashok	136
31	Role Of Reserve Bank Of India In Indian Economy	Prof.Take Kishor Bhausahab	141
32	Impact Of GST On The Indian Economy	Prashant Prakash Dhanave	144
33	Agriculture Productivity	Prof.Dr.Deepak Pandharinath Sontakke	152
34			156

RUSA, DST, FIST sponsored National Seminar on “Challenges before Indian Economy”.

By Department of Commerce and Economics, N.A.C.& S. College, Parner, Dist- Ahmednagar (M.S.)

Challenges before the Skill Development in India

Dr. Vinay S. Rannavare
Asso. Prof. ,
Ahmednagar College,
Ahmednagar

Dr. Bhushan D. Bhalerao,
Asst. Prof.
New Arts Commerce & science College,
Parner

By 2023, 70 million more people will have entered India's workforce – but what skills will they need?

Over half of India's workers will need reskilling by 2022. We set up a taskforce to help.

This article is part of the **India Economic Summit**

As structural, demographic and technological shifts transform the Indian economy and the nature of work, new entrants to the labour force will have to be skilled and made employable. Approximately 70 million additional individuals of working age (15-59 years) are expected to enter the country's labour force by 2023 – using the same estimation model, the total workforce will then include approximately 404.15 million people. This will include 59 million youth (individuals aged 15-30 years), according to our analysis of data from the Periodic Labour Force Survey (PLFS) 2017-2018. Strategies for reskilling and increasing the skills of the current workforce, as well as formal recognition of informally acquired skills, will also have to be reinforced.

Against this backdrop, India is driving unique initiatives to convert its demographic potential into a dividend that will fuel the country's growth. At the same time, ageing populations found in several developed countries present opportunities for the migration of skilled persons from India to the benefit of both the host and destination countries.

Have you read?

There have been three major challenges to skills development in India: expanding public sector collaboration with industry and the private sector, creating pathways for international mobility and addressing women's low participation in the labour force.

Here's how the National Skill Development Corporation (NSDC) has approached them: Industry and private sector collaboration Creating avenues for private sector engagement has been a crucial strategic pillar for India. Skill development faces several forms of market failures, including information asymmetries – a skilled person knows his or her skills, but a potential employer does not; if employers had all the information, their willingness to pay for a skilled person would rise. Recognition of Prior Learning (RPL) is an example of an intervention to address information asymmetry.

RUSA, DST, FIST sponsored National Seminar on “Challenges before Indian Economy”.

By Department of Commerce and Economics, N.A.C.& S. College, Parner, Dist- Ahmednagar (M.S.)

Another market failure in skill development is externalities. For example, when a firm spends resources on developing the skills of an employee, he or she can quit and join another firm, thus benefitting the latter firm and not the firm that incurred the training cost.

Where there are such market failures, there is a prima facie rationale for government intervention. As A.C. Pigou argues in 1912's *Wealth and Welfare*, firms themselves do not have an incentive to spend on developing the skills of their workers, because, as mentioned, a skilled worker can quit and join a new firm. Workers have an incentive to invest in their own general skill training through, say, apprenticeship (wherein they are willing to work for lower pay) or self-paid training, as they stand to potentially benefit from higher salaries when they switch jobs. As such, firms may be willing to spend on developing specific skills of employees.

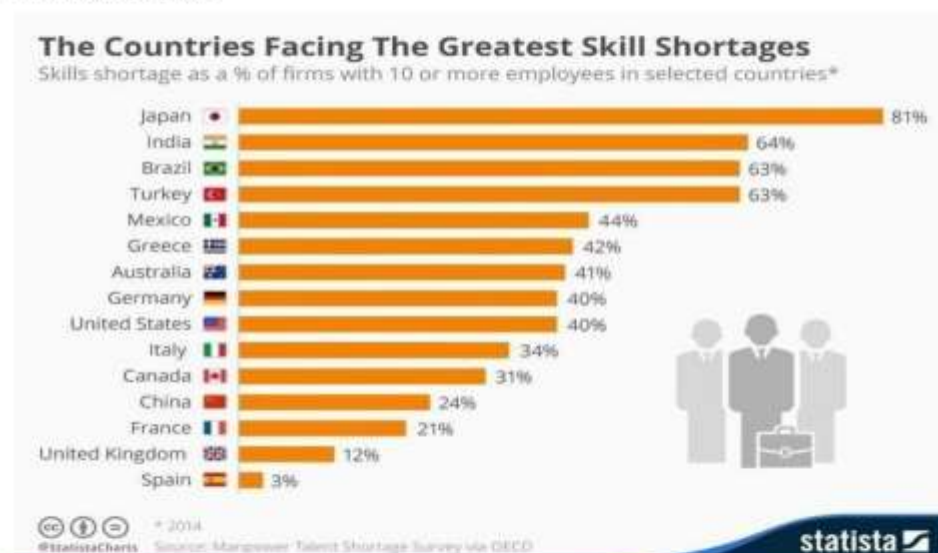

In India, there are a variety of skill development models – government-funded programmes that fully or partially subsidize training/apprenticeships, market-led trainings (where trainees pay for the course), market-led apprenticeships and industry-led/on-the-job training. The not-for-profit National Skill Development Corporation (NSDC) was set up as a public-private partnership (PPP) to stimulate private sector participation in the Indian skill development sector. A core role of the NSDC is, therefore, providing long-term development finance to organizations to build for-profit vocational training initiatives. We also work closely with the Ministry of Skill Development and Entrepreneurship (MSDE) to implement government grant-based vocational training programmes, where infrastructure is set up by private providers and training costs are subsidized by the government.

Collaboration with industry has been fundamental to ensure the relevance and quality of skills training and for building the institutional structures required to achieve the desired outcomes. Sector Skill

RUSA, DST, FIST sponsored National Seminar on “Challenges before Indian Economy”.

By Department of Commerce and Economics, N.A.C.& S. College, Parner, Dist- Ahmednagar (M.S.)

Councils (SSCs) were incubated by the NSDC for fostering industry connections and developing an industry-relevant course and curriculum. There are currently 37 SSCs operational, with more than 600 corporate representatives in their governing councils.

India’s labour force above 30 years of age is 262 million people, according to our analysis, of which 259 million are currently employed and need to be future-ready. As such, our work has also used industry partnerships to drive reskilling and up skilling initiatives and to develop close collaborations with employers to prepare their workforce for new technologies and the future of work.

There is a vast segment of informal workers in India, many of whom possess skills that have not been formally recognized. RPL interventions are critical in this scenario – holding a formal certification can improve an individual’s bargaining power. In a third-party evaluation of the RPL component of the Pradhan Mantri Kaushal Vikas Yojana (PMKVY) conducted by Sambodhi Research and Communications, 75% of RPL-certified individuals said they were more prepared for their current job and 79% said that the programme has made them more confident about getting a better job.

The same analysis suggests the monthly incomes of RPL-certified individuals were on average 19% higher than those who had not been RPL-certified. An average increase of 25% in income after certification was reported.

Analysis of an as yet unpublished household survey conducted by the Centre of Monitoring Indian Economy (CMIE) suggests there are more than 390 million individuals who have acquired skills informally – through self-learning, on-the-job learning, inherited skills or other sources. Of these, a majority (384 million) are working, showing the scope for RPL and apprenticeship-related interventions. Both of these interventions typically involve collaboration with industry and the private sector, even when they are part of publicly funded programmes or schemes.

Encouraging International Mobility

India is committed to becoming the “skill capital” of the world and structured efforts such as the India International Skill Centre (IISC) programme are evidence of this. A new, market-driven IISC network has been proposed to counsel and guide potential emigrants with a focus on skills tests, upskilling, language and pre-departure orientation. Furthermore, the governments of India and Japan are cooperating to implement Japan’s Technical Intern Training Programme (TITP), an on-the-job training scheme providing three to five years of internship opportunities for foreign nationals in Japan, with NSDC as the implementing organization.

Technical collaborations have been undertaken with countries such as the UK, Australia and the UAE for benchmarking and mutual recognition of standards. Government-to-government and B2B

RUSA, DST, FIST sponsored National Seminar on “Challenges before Indian Economy”.

By Department of Commerce and Economics, N.A.C.& S. College, Parner, Dist- Ahmednagar (M.S.)
partnerships are also being developed for new markets such as those in Western Europe, Canada, Australia and East Asia to increase the mobility of blue and white-collar Indian workers.

Women’s Participation In The Labour Force

A third focus area for us is addressing the challenge of low female participation in the labour force. Our analysis of labour force survey data suggests that of the country’s labour force of 395.2 million, only 91.6 million are women.

Skilling initiatives – complemented by a wider push towards empowerment through gender sensitization, creation of economic opportunities and economic and social support – can be used to raise this number. Providing residential facilities for women trainees, embedding mentoring and coaching in skills programmes and providing social support through mechanisms such as local workshops have all been explored.

Preparing women for forms of employment that are more attractive to them, such as the gig economy and its more flexible work models, is especially relevant, given that 229.2 million women (out of the 301.5 million who are not in the labour force) report their status as “attending domestic duties”, in our analysis.

Encouragingly, our progress so far in terms of creating access to skill development for women has been positive. More than 50% of the candidates trained under PMKVY are women. A significant number of women have also been trained in unconventional roles, such as in the electronics and hardware sectors. On our paid courses, women account for 40% of trained candidates. Here too women are increasingly enrolling for unconventional job roles, such as field technician, organic grower and automation specialist. Several training providers in our system focus exclusively on women and are promoting skill training in areas including digital and financial literacy, entrepreneurship, website design, 2D and 3D design, hardware repair and farm management. Partnerships with industry to support women-centric projects in non-traditional trades have also been explored.

References:

1. Manish Kumar Managing Director and Chief Executive Officer, National Skill Development Corporation.
2. Economic Times Article

36. Impact of GST on Indian Economy

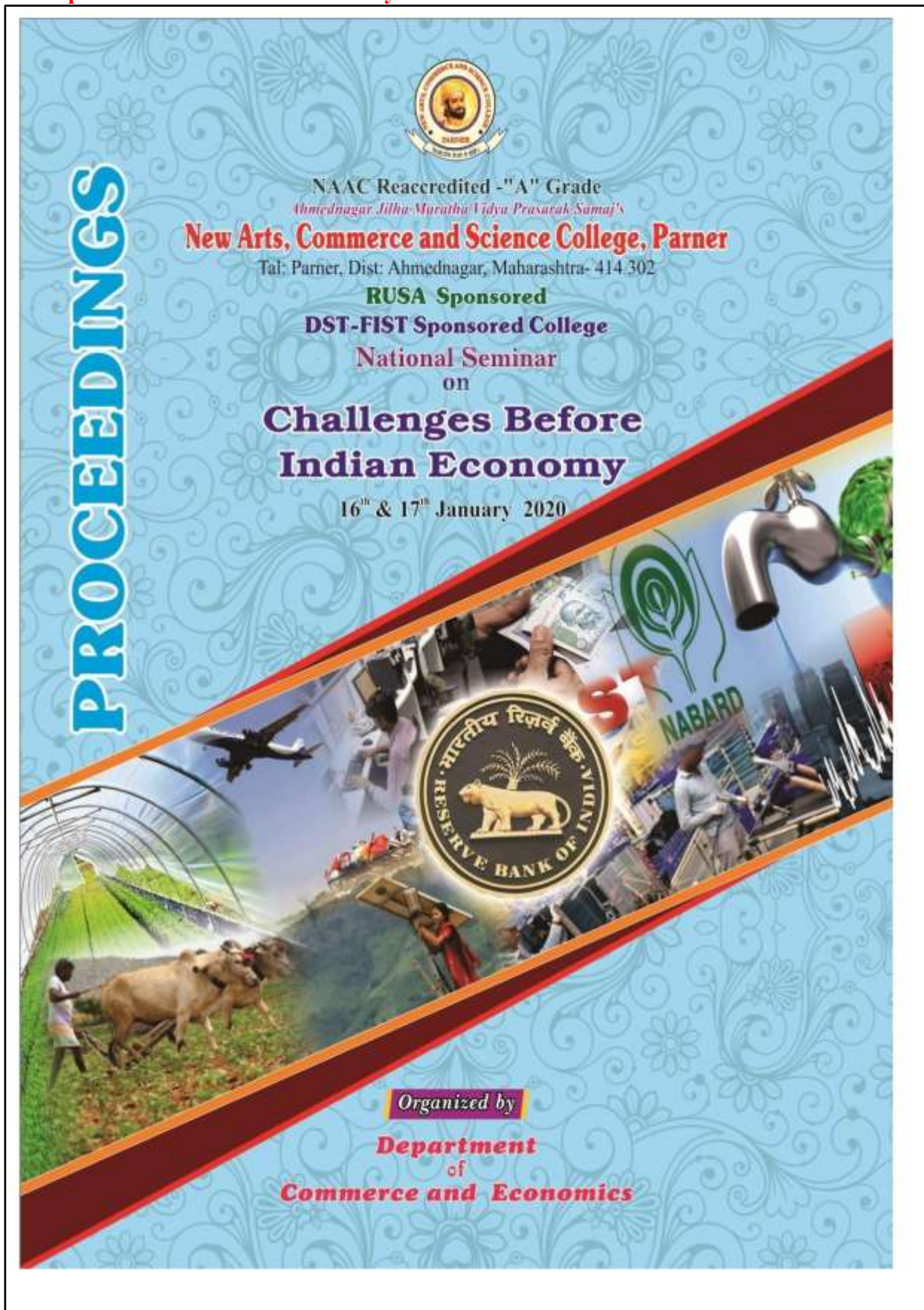

Contents

Sr. No.	Name Of Researchers	Title Of Research Paper	Page No
1.	Agrarian Distress In Indian Agriculture :Emerging Challenges And Policy Implementation	Dr. Bhausaheb .Y. Deshmukh	01
2.	Challenges Before Indian Economy	Prof. Darekar B.P.	10
3.	Problems & Prospects Of Agrobased Industries In Economical Development Of India –A Study	Thorat Rahul Dagadu (Research Scholar) Dr. Mote D.K. (Associate Professor)	14
4.	विक्रम - 'कृषि विकास' योजना	कृषि विकास -	18
5.	Waiving Farm Loans Is Not Only Bad For The Economy But Also Detrimental To Interests Of The Farmer	Prof. Amita Bhushan Bhalerao	21
6.	Positive And Negative Impact Of GST On The Indian Economy	Asst. Prof. Datir K.R.	24
7.	Impact Of GST On Indian Economy	Mr.Galbote Tushar Ambadas	28
8.	Indian Rural Development : Issues And Challenges	Dr. Govind S Deshmukh	33
9.	Role Of RBI, NABARD In Indian Economy	Prof. Pingat Savita Pandurang	37
10.	Challenges Before Service Sector In India	Dr. Sudhir R. Wagh (Head, Department Of Zoology) Mr. Yuvaraj M. Waghare (Head, Department Of Commerce)	42
11	Impact On GST On Indian Economy	Prof.Mohalkar S.D.	46
12	Emerging Trends In Marketing	Prof. Sushil D. Pawar	49
13	Agriculture Sector In India	Mr. Shivaji Rangnath Pathare	54
14	Impact Of GST On Indian Economy	Prof. Shinde M.D	58
15	Challenges Before Agricultural Sector In India	Dr. Sunita Sadashiv Thube	64
16	Impact Of Inflation On Indian Economy	Prof. Kale Sachin Vijay (M.A.,M.Phil,SET)	71
17	Importance Of Service Sector In India	Dr.B.P.Thakur (M.A.M.Phil.Ph.D)	74
18	Impact Of GST On Indian Economy	Dr.Salve Dharmendra Bhagwan	78

RUSA, DST, FIST sponsored National Seminar on “Challenges before Indian Economy”.

By Department of Commerce and Economics, N.A.C.& S. College, Parner, Dist- Ahmednagar (M.S.)

Impact of GST on Indian Economy

Mr. Galbote Tushar Ambadas

Assistant Professor, New Arts Commerce & Science College, Parner 414-302

Mo. No.7276752221

Mail:galbotetushar92@gmail.com

Abstract:

GST is a single national uniform tax levied across India on all goods and services. In GST, all Indirect taxes such as excise duty, central sales tax (CST) etc. Introduction of The Goods and Services Tax (GST) expected as a significant step towards a comprehensive indirect tax reform in the country, which would lead India for its economic growth. The Proposed study is designed to know the impact on GST on Indian Economy with the help of Its individual effect on different sectors. The Study is Exploratory in nature and Secondary Data has been used for the study. The data will be collected from different Journals, Periodicals, Newspapers and Internets.

Impact of GST on Indian Economy

To remove cascading (Double) effect of taxes, the Government of India proposed for amendments to introduce the goods and services tax for giving concurrent taxing powers on the union as well as states including union territory with legislature to make laws for levying goods and services tax on every transactions. GST is an indirect tax has introduced on 1 July 2017 in India and was applicable throughout India which replaced multiple cascading (Double) taxes levied both by central and state governments. The GST is governed by a GST Council. Under GST, goods and services are taxed at the vary rates, 0%, 5%, 12%, 18% and 28% and there is a special rate of 0.25% on rough precious and semi-precious stones and 3% on gold Further in addition a cess of 15% or other rates on top of 28% GST applies on few items like aerated drinks, luxury cars and tobacco products. Expert viewed it as biggest tax reform in India founded on the notion of “one nation, one market, and one tax”. The entire taxation base will be shared between the assessment mechanism of the center and the states that would get to collect tax on the economic activities taking place in Indian territorial waters.

Objectives

- To understand the concept of goods and service tax
- To find out effect of GST on Economy.

5 | Page

RUSA, DST, FIST sponsored National Seminar on “Challenges before Indian Economy”.

By Department of Commerce and Economics, N.A.C.& S. College, Parner, Dist- Ahmednagar (M.S.)

- To find out the Impact of GST in future on Economy.

Methodology:

The proposed study based on the secondary data sourced from journals, Internet, articles, previous research paper, parliament library and reference research etc.

Review Literature:

“Goods and service tax its impact on Indian Economy” stated that The goods and services Tax (GST) will indeed be a significant improvement towards a comprehensive indirect tax reforms in India and it would give India a world class tax system and improve tax collections. It would end distortions of differential sectors .Further viewed that it would lead to the abolition of taxes such as central sales tax, state level sales tax, octroi, entry tax, stamp duty, tax on consumption. GST is expected to create a business friendly environment in India, as a result price levels and inflation rates would come down overtime because of application of uniform tax rate. More over It will also improve government's fiscal health as the tax collection system would become more transparent, making tax evasion difficult. It is way forward that The Goods and Service Tax (GST) is one of the biggest taxation reforms in India The central idea behind this form of taxation is to replace existing levies like VAT, , service tax ,excise duty and sales tax by levying a comprehensive tax on the manufacture and consumption of goods and services in the country. GST is expected to unite the country economically as it will remove various forms of taxes that are currently levied at different points.

GST is Big Leap in the Indirect Taxation System, and found that the positive impacts are dependent if design of the GST is rational and if balance the conflicting interests of various stakeholders. Further he said GST would be a big leaf ion the indirect tax system and also give a new impetus to India is economic change. The implementation of the GST would be pegged as one of the biggest game changing reforms of the Indian government, which will help Indiatio become an economically integrated economy and help to reduce business costs and facilitate seamless movements of goods and services eliminating local charges.

An overview of GST and Its impact on different sectors

If talk about impact of GST on manufacturers, distributor and retailers It is believe GST is expected to boost competitiveness and performance in India's manufacturer due to tax structure. High infrastructure spending and declining export are just some of the concerns of this sector. Single tax system will decrease the administrative costs for manufacturers and distributors and this sector will grow more strongly.

6 | P a g e

RUSA, DST, FIST sponsored National Seminar on “Challenges before Indian Economy”.

By Department of Commerce and Economics, N.A.C.& S. College, Parner, Dist- Ahmednagar (M.S.)

If thrown glance on impact of GST on Service Providers it is observe that most of the tax burden is borne by domains such as telecommunication services, Insurance industry, business support services, Banking and Financial services , IT services etc. Introduction of GST will decrease burden. The Logistic industry forms the backbone of the economy. We can fairly assume that a well- organized and mature logistics industry has the potential to shoot ahead the “Make In India” initiative of the Government of India and has positive impact on economy. Simultaneously GST will help the e- com sectors growth but the long-term effects will be particularly interesting because the model GST law specifically proposes a tax collection at source (TCS) mechanism, If talk about Pharma industry GST is expected to benefit the pharma and healthcare industries. It boost medical tourism with simplified tax structure. *Telecommunications* sector prices are expected to come down after GST. Manufacturers will save on costs through efficient management of inventory. Handset manufacturers will find it easier to sell their equipment as GST will negate the need of the state and will also save up on logistics costs. Textile industry generates employment to a large number of skilled and unskilled workers . It contributes about 10% of the total annual export, and this value is likely to increase under GST. GST would affect positively to the cotton value chain of the textile industry which lead economic growth. The real estate sector is also plays important role in the Indian economy, it Plays an important role in employment generation in India. The sector will see substantial benefits from GST implementation. Agricultural sector is the largest contributor of GDP. It covers 16% of GDP. The major issues faced by the agricultural sector, is transportation of agri products across state lines. It is expected that GST will resolve the issue of transportation. FMCG sector could rise significant savings in logistics and distribution costs as the GST will eliminate the need for multiple sales depots. The GST rate for this sector is expected to be around 17% which is way lesser than the 24-25% tax rate paid currently by FMCG companies. Under the current tax system, there are several taxes applicable on automobile sector like excise, VAT, sales tax, road tax, motor vehicle tax, registration duty which will be subsumed by GST.

An analysis on GST and its impact on Indian Economy

The implementation of goods and service Tax(GST) coupled with a digitized economy ushered in by demonstration, will make India’s economy” look much cleaner and bigger “said union finance minister ArunJaitely at the vibrant Gujarat global Summit. Further he said ,it is going to be a major step towards the integration of informal economy and this itself is going to increase the transactions, which are covered within the Banking system transactions and may lead to higher revenue in the future . “A new India Has Emerged It is inevitable that with the

7 | P a g e

RUSA, DST, FIST sponsored National Seminar on “Challenges before Indian Economy”.

By Department of Commerce and Economics, N.A.C.& S. College, Parner, Dist- Ahmednagar (M.S.)

increase in level of demand, the level of supply would respond likewise. The GST council is being asked by the ministry of Commerce to keep exporters of the plantation, leather and cement out of its framework and suggested to impose lower tax on them to boost output and increase employment generation. With this the producers increase productivity and perform better in global markets council retained its proposed definition of Agriculturist to allow a land to have been personally cultivated only if its farmed by individuals and family members of HUF and its exempted under GST. Manufacturers and traders would benefit from fewer tax filings, transparent rules and overall a sound book keeping system. Consumers would be paying less for the goods and services and lead to change their expenditure pattern and livelihood, The government would generate more revenues as revenue leaks would be plugged by GST implementation. How has GST really impacted India in current economy situation and in future. Firstly: from the viewpoint of the consumer, the consumers have pay more tax for most of the goods and services they consume. The GST implementation has a cost of compliance and tax on most of the goods attached to it. It examine that this cost of compliance will be prohibitive and slightly high for the small scale manufacturers and traders. Resulted to this pricing of goods will go high and has direct impact on cost of living of the society. Secondly: If long term effect of GST analyses it is expected that GST would not just mean a lower rate of taxes, but also minimum tax slabs imposed on .In many Countries where the Goods and Service Tax has helped in reforming the economy, apply only 2 or 3 rates .GST is designed to minimize the rate with a lower rate for essential commodities, and a higher tax rate for the luxurious commodities. Currently, in India, there are 5slabs, but there will be a shift soon .thirdly ;Impact of GST on macroeconomic indicators is likely to be very positive in the medium-term. Inflation would be reduced as the cascading (tax on tax) effect of taxes would be eliminated in the country and at the same time revenue from the taxes for the government is very likely to increase with an extended tax net, and the fiscal deficit is expected to remain under the checks and GST would be a change maker on this. Moreover, exports would grow, while FDI (Foreign Direct Investment) would also increase. The experts believes that the country would grow economically in the case of doing business with the implementation of the most important tax reform ever in the history of the country.

Conclusion

A single taxation system would encourage new businesses and entrepreneurs to engage in service and manufacturing sector. GST levied only on consumption of goods or services .This leads to eliminate economic distortions in taxation amongst states and also helps in free movement of goods, further it also minimize the complexity of taxation. It will also beneficial

8 | P a g e

RUSA, DST, FIST sponsored National Seminar on “Challenges before Indian Economy”.

By Department of Commerce and Economics, N.A.C.& S. College, Parner, Dist- Ahmednagar (M.S.)

to individuals as the prices will go down due to GST and decrease in price leads to increase in consumption and directly increase the GDP. As GST implementation applied at a time for all states lack of policy barrier will be removed. Directly GST will increase the investment in FDIs which increase the foreign exchange of the country and indirectly increase the employment opportunities. It will promote new startups in India for its business-friendly tax structure.

Bibliography

1. Goods and Services Tax (GST) - A step forward (2013) available at www.articles.economictimes.indiatimes.com
2. Fe Bureau, New Delhi, Jan 17 Jan 2017 “GST Council settles dual; control issue”, Financial Express.
3. Nair Avinash, (Jan 12 2017), “GST plus digital will make economy bigger, cleaner: Jaitley”, Indian Express.
4. www.indiataxes.com
5. www.articles.economictimes.indiatimes.com
6. www.taxmanagementindia.com
7. www.goodsandservicetax.com

37. Important Challenges and Prosperous of Indian Economy reference to Agriculture Sector

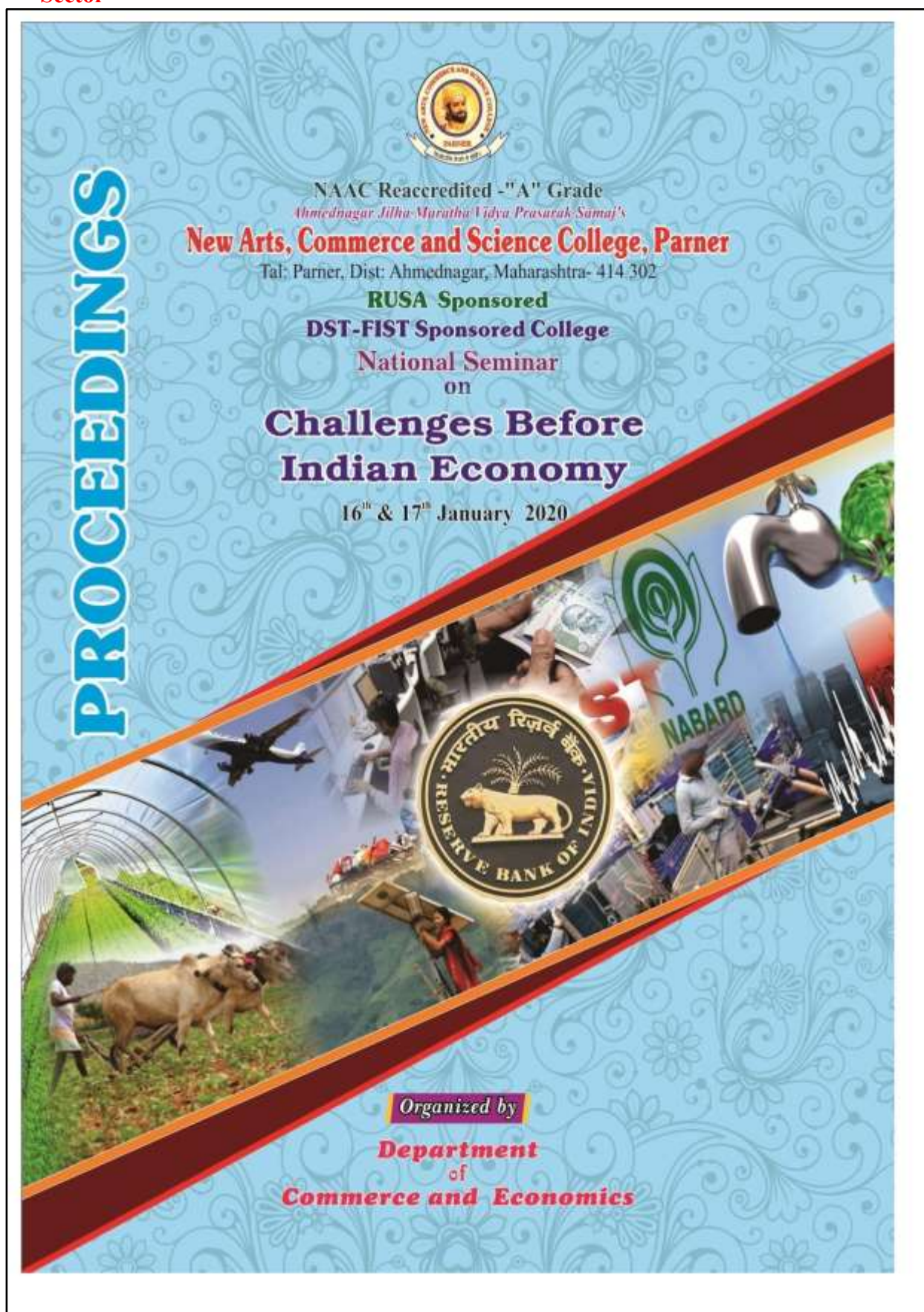

Contents

Sr. No.	Name Of Researchers	Title Of Research Paper	Page No
1.	Agrarian Distress In Indian Agriculture :Emerging Challenges And Policy Implementation	Dr. Bhausaheb .Y. Deshmukh	01
2.	Challenges Before Indian Economy	Prof. Darekar B.P.	10
3.	Problems & Prospects Of Agrobased Industries In Economical Development Of India –A Study	Thorat Rahul Dagadu (Research Scholar) Dr. Mote D.K. (Associate Professor)	14
4.	विक्रम - 'कृषि विकास' योजना	कृषि विकास -	18
5.	Waiving Farm Loans Is Not Only Bad For The Economy But Also Detrimental To Interests Of The Farmer	Prof. Amita Bhushan Bhalerao	21
6.	Positive And Negative Impact Of GST On The Indian Economy	Asst. Prof. Datir K.R.	24
7.	Impact Of GST On Indian Economy	Mr.Galbote Tushar Ambadas	28
8.	Indian Rural Development : Issues And Challenges	Dr. Govind S Deshmukh	33
9.	Role Of RBI, NABARD In Indian Economy	Prof. Pingat Savita Pandurang	37
10.	Challenges Before Service Sector In India	Dr. Sudhir R. Wagh (Head, Department Of Zoology) Mr. Yuvaraj M. Waghare (Head, Department Of Commerce)	42
11	Impact On GST On Indian Economy	Prof.Mohalkar S.D.	46
12	Emerging Trends In Marketing	Prof. Sushil D. Pawar	49
13	Agriculture Sector In India	Mr. Shivaji Rangnath Pathare	54
14	Impact Of GST On Indian Economy	Prof. Shinde M.D	58
15	Challenges Before Agricultural Sector In India	Dr. Sunita Sadashiv Thube	64
16	Impact Of Inflation On Indian Economy	Prof. Kale Sachin Vijay (M.A.,M.Phil,SET)	71
17	Importance Of Service Sector In India	Dr.B.P.Thakur (M.A.M.Phil.Ph.D)	74
18	Impact Of GST On Indian Economy	Dr.Salve Dharmendra Bhagwan	78

19	Impact Of New FDI In E-Commerce Rules In India On Customers	. Nikhil Bharat Goyal (M.Com., FCA, NET, SET)	80
20	Impact Of GST On Indian Economy	Thube Pranita Santosh	83
21	Role Of Banking System In The Economic Growth And Development	Dr. S. R. Bakhale Prof. S. S. Thorat	87
22	Introduction To Indian Economy And Problems Faced By It	Prof. Ranjit A. Shinde	93
23	Demonetization And Its Effect On Indian Economy	Mr. Satbhai Abhijit Prakash	99
24	Role Of RBI, Nabard In Indian Economy RBI	Mr. Surendra Laxmanrao Bhujbal	106
25	Indian Economy And Rural Development	Dr. Bhandari Mousmi Jitendra	112
26	Challenges Before The Skill Development In India	Bhushan D. Bhalerao	114
27	Impact Of GST On Indian Economy	Dr. Karuna B. Kamble	126
28	Impact Of GST On Indian Economy	Dr. Karuna B. Kamble	126
29	Impact Of GST On Indian Economy	Dr. Karuna B. Kamble	126
30	Important Challenges And Prosperous Of Indian Economy: Reference To Agriculture Sector	Dr. K.M.Tele	136
31	Economical Challenges In Front Of Indian Government & It's Solutions	Prof. Thombare Sandip Ashok	141
32	Role Of Reserve Bank Of India In Indian Economy	Prof. Take Kishor Bhausaheb	144
33	Impact Of GST On The Indian Economy	Prashant Prakash Dhanave	152
34	Agriculture Productivity	Prof. Dr. Deepak Pandharinath Sontakke	156

RUSA, DST, FIST sponsored National Seminar on “Challenges before Indian Economy”.

By Department of Commerce and Economics, N.A.C.& S. College, Parner, Dist- Ahmednagar (M.S.)

**IMPORTANT CHALLENGES AND PROSPEROUS OF INDIAN ECONOMY: REFERENCE
TO AGRICULTURE SECTOR**

Dr. K.M.Tele

Assistant Professor, New Arts, Commerce & Science College, Parner.

E-mail: kmtele@gmail.Com

Abstract

The basic characteristics of underdeveloped countries discussed in research paper might as well be regarded as the obstacles to economic development. Even though the general characteristics of underdevelopment are not common to all the underdeveloped countries. Yet broad answer to the Question why a poor country is poor is implicit in these characteristic. A number of these characteristics are both the causes and consequence of poverty, unemployment, education, health care, price control, agriculture, industry, service sectors. The above factors analyze the causative relationship that inhibits development. Each and every citizen of the country has a right to lead a decent life. Everybody must be able to fulfill minimum needs such as food, health care, housing basic education etc. However, India is a poor country where a large section of the population cannot afford all there. The matter is made worse due to the fact that our economy does not provide adequate employment opportunities so that poor people cannot get jobs and earn income. Hence eradication of poverty and unemployment is a major challenge before the economy similarly higher quality of life is achieved by getting proper education and health care facilities. Agriculture is a basic occupation. It is the oldest business in the world and nearly two thirds of the population of the world is dependent on agriculture for its livelihood. Agricultural progress is normally regarded as a prerequisite of economic development. Agriculture is the foundation on which the entire superstructure of the growth of industrial and other sectors of the economy has to stand. Industrialization plays a crucial role in the economic development of a country. Industrialization means development of industries, mining power plants, transport etc. It is a continuous process of creation and growth of factors, mills, mines, power plants etc. In a developing country like India building up of industries is essential without the development of industries economic development is impossible in fact, industrialization. It is in this context service sector together play crucial role indeed services have grown an important in Indian economy. Today majority of population earn their livelihood from service sector. Service sector is “Tertiary Sector” of Indian economy. It covers a wide range of activities like banking and finance, insurance, tourism and transportation, trading construction and related activities, Education, information technology, software services and on.

RUSA, DST, FIST sponsored National Seminar on “Challenges before Indian Economy”.

By Department of Commerce and Economics, N.A.C.& S. College, Parner, Dist- Ahmednagar (M.S.)

Keywords Agriculture, Education, Information, Software, Tertiary, Livelihood, Self Sufficient.

Research Methodology

This study is depends upon secondary sources related to reports, research paper, government publication, books etc. This is a concept paper and the researcher has adopted the method of reviewing different research article, research journals, website and articles and Govt. Gazzets.

Challenges and prosperous of economy:**1) Poverty and unemployment:**

According to planning commission of the govt. of India anybody who is not able to get 2400 kilo calories (kcl) from food intake in rural area and 2100 Kcal. from food intake in urban area is termed as poor. This is called as poverty line in India. It is true that food is most essential for our existence we take food to get energy for our body so that we can perform certain activities. Energy is measured in term of kilo calories. In rural areas people do lot of hard work to earn their living. According to experts the minimum energy required by person for doing such work is 2400 K cal. in rural and 2100 K cal. urban area. To get this energy a person requires some amount of food in the form of cereals, pulses, vegetables etc. to by these food items the person must have some amount of money. This implies that if the person is not able to earn this money to buy the food needed in order to get the required energy to do work, then the person is said to be below poverty line or simply poor, these essential things such as clothing, shelter and essential goods etc. These goods also come under minimum requirement to buy all these items. One reason being unemployment among the population who are willing to work but there is no work for working persons. The economic growth rate is very slow due to there is no work then the suffering the labor class for their earning. The slow growth of industries, education and training are main reason for unemployment in India. Also our agriculture is already over burden with population and employment is seasonal there. Four main causes of poverty in India are as follows: It is said that “a country is poor because it is poor.” This idea has come down from Ragner Nurkse who pin pointed the problem of vicious circle of poverty, low level of saving reduce the scope for investment, low level of investment yields low income and thus, the circle of poverty goes on indefinitely, measures to poverty. The govt. has relied mainly on the approaches for reduction of poverty. The first entails pursuit of higher economic growth which will improve the level of living of all groups of people in the society including the poor. The second involves direct antipoverty program and third has stressed high priority to govt. expenditure on social sectors, the govt. Has launched several poverty alleviation programmed.

2) Unemployment or problem of unemployment:

India has been facing the problem of unemployment and labor surplus, unemployment is normally found in all economics, but it is serious in the Indian economy. Unemployment depicts the darker side of

RUSA, DST, FIST sponsored National Seminar on “Challenges before Indian Economy”.

By Department of Commerce and Economics, N.A.C.& S. College, Parner, Dist- Ahmednagar (M.S.)

economic progress and it only illustrates inefficient utilization of human resources, lower production and lower standard of living.

Causes of unemployment in India:

The problem of unemployment in India is deeprooted and complex. It is a result of interaction of a number of forces which are following reason.

01. Excessive growth of population.
02. Slow growth production.
03. Backwardness of Agriculture
04. Lack of manpower planning
05. Increase in labor force
06. Defective Education System
07. In appropriate technology
08. Neglect of small Scale and cottage industries
09. Immobility of labor

Measuring policy of The Governor:

Though the removal of unemployment has been proclaimed goal Indian economic planning on attempts is made to implement a long term strategy so far. The employment orientation programmed implements under a different five year plans include small farmer development agency. The marginal farmers and agricultural labor development Integrated Rural development programme. The scheme of training for youth employment, the Rural land less employment Guarantee programmed. Jawar Rojgar Yojana, Nehru Rojgar Yojana. The schemes main aim is providing more and more employment opportunities in rural and urban areas in India. The Indian population day by day increases in increasing rate, the above policies are creating the more job opportunities in rural as well as urban level. The main aim is more and more job opportunities and provide types job in rural and urban areas with the help above measuring policies.

3) Industrialization in economic development:

Industrialization plays a vital and crucial role in economic development of an under-development nation (like India) compared to the developed nations. Which are largely industrial economics the under developed nation are predominantly agricultural economics. Industrialization in such a underdeveloped nations is dependent on the role of agricultural sector. In India industrialization plays an important role in modernizing agriculture and improving productivity in that sector. Similarly agriculture plays an important role in the industrial development. Industrialization accelerate economic growth following various ways-

01. Industrialization increase per capita income.

RUSA, DST, FIST sponsored National Seminar on “Challenges before Indian Economy”.

By Department of Commerce and Economics, N.A.C.& S. College, Parner, Dist- Ahmednagar (M.S.)

02. Industrialization expands employment opportunities.
03. Industrialization brings increasing returns.
04. Industrialization builds a self radiant and self sustained economy.
05. Industrialization generate modern attitude.
06. Industrialization ensures growth with stability.
07. Industrialization provides expending market.
08. Industrialization increase in national income.

Some problem of Industrialization;

The small scale and cottage big industries are beset with a number challenges. Many of big industries are sick at the end of 2010. There were as many 13.5 % big units in the country. The industries, due to various problems have failed to make their contribution to the full to the development of country along the desirable lines. The important problems are shortage of capital. The institutions which provide finance to their industries are not adequately developed. As result they are faced capital shortage. The next problem is raw material. Raw materials are not available in sufficient quantities at require site quality and at seasonal rates. Due to this there is wastage of productive capacity and many units thus incur hugs losses.

4) Service sectors role in Development:

The service sector with around 57% contribution to gross domestic product GDP in 2014-15, has made rapid strides in the past decade and a half encourage as the largest and one of the fastest growing sectors of the economy. The service sectors is not only the dominant sector in India's GDP, but has attracted significant foreign investment flow, contributed significantly to expect has as well as provide large scale employment. India's service sector cover a wide variety of activities such as made. Hotel and restaurants, transport, storage and communication, financing, insurance, real estate, services, community social and personal service and services associated with construction. As result employment also adjusting to changes and people are leaving the agriculture sector to find work in the service sector. This job creation is particularly use full as often it provides employment for low skilled labors in the tourism and retail sectors. Thus benefiting the poor in particular and repenting an overall increase in employment. The service economy in developing countries is most often made up the financial services, tourism distribution, health and education etc. India has the second fastest growing services sector with its compound annual growth rate at nine percent, just below China's 10.9 % during the last 11 year periods from 2001-2012. The economic survey for 2013-2014 said Russia at 5.4 % is a distant third. Among the world's level countries are in terms of GDP.

Conclusion

RUSA, DST, FIST sponsored National Seminar on “Challenges before Indian Economy”.

By Department of Commerce and Economics, N.A.C.& S. College, Parner, Dist- Ahmednagar (M.S.)

01. On major reason of poverty being employment among the population who are using to work, the govt. provided the employment opportunities in various sectors and through govt. policies.
02. The govt. introduced various schemes for the poor people for creating job opportunities. That is to remove the poverty and solve the problem of unemployment of the nation.
03. The education is king pin of the all sectors of Indian economy. The govt. of India has taken different measures to provide education to all peoples (student). The govt. has taken several steps to develop higher and technical education.
04. The govt. of India more priority given to health care of peoples. The health is wealth says the slogan according to that slogan the health is most important. The govt. taken the care of health due to provided the health care facilities to Indian peoples.

References

- 1) Bimal Jalan :- Indian Economy; Problems and Prospects of Indian economy.
- 2) Agrwal A.N. :- Indian Economy; Problems and Development and Planning.
- 3) Dr. Chandrashekhar Prasad :- Agriculture and sustainable envelopment in India.
- 4) Mishra R.S. :- Economics of Development.

38. Introduction To Indian Economy and Problems Faced By It

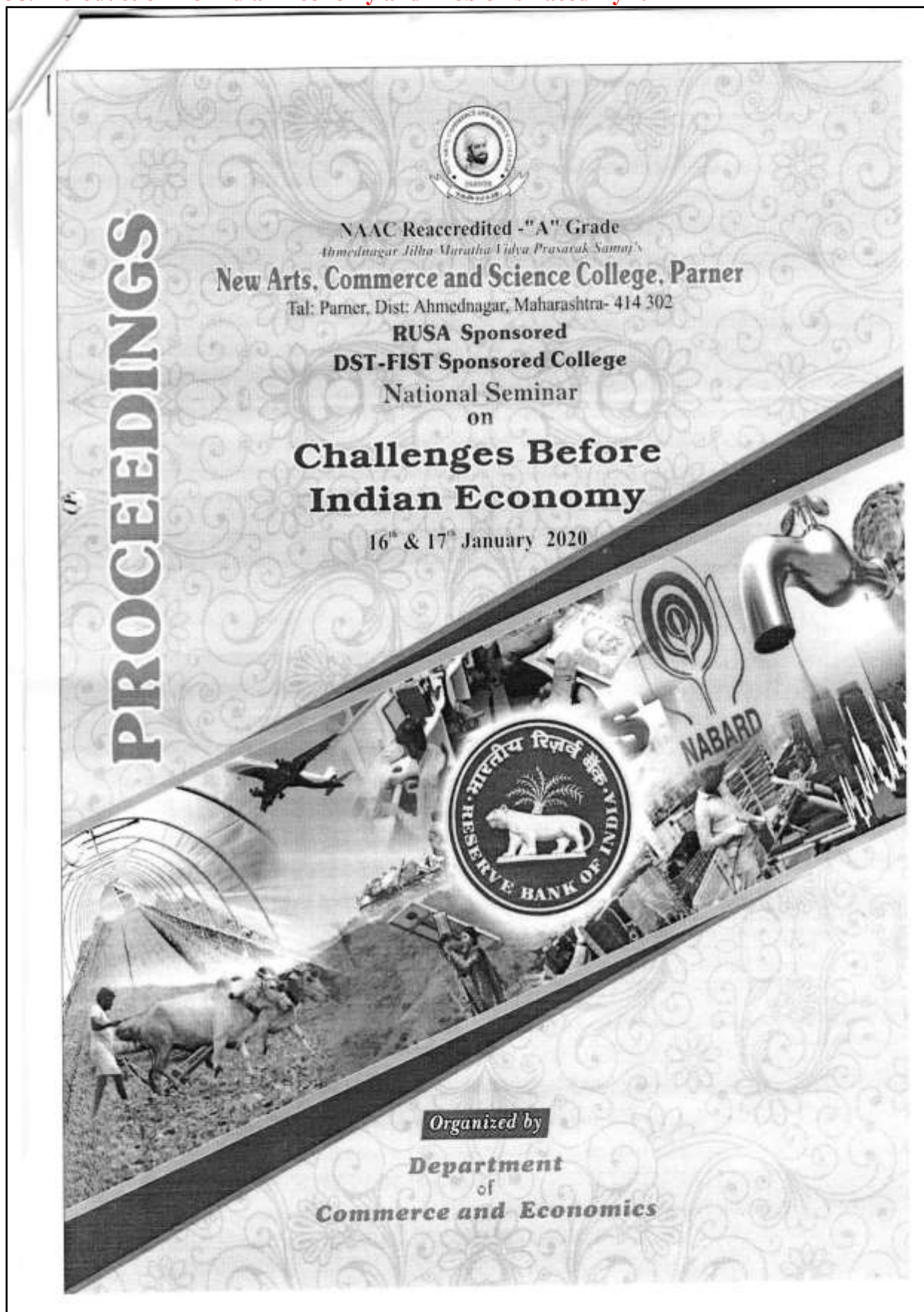

19	Impact Of New FDI In E-Commerce Rules In India On Customers	Nikhil Bharat Goyal (M.Com., FCA, NET, SET)	80
20	Impact Of GST On Indian Economy	Thube Pranita Santosh	83
21	Role Of Banking System In The Economic Growth And Development	Dr. S. R. Bakhale Prof. S. S. Thorat	87
22	Introduction To Indian Economy And Problems Faced By It	Prof. Ranjit A. Shinde	93
23	Demonetization And Its Effect On Indian Economy	Mr. Satbhai Abhijit Prakash	99
24	Role Of RBI, Nabard In Indian Economy RBI	Mr. Surendra Laxmanrao Bhujbal	106
25	Indian Economy And Rural Development	Dr. Bhandari Mousmi Jitendra	112
26	Challenges Before The Skill Development In India	Bhushan D. Bhalerao	114
27	Impact Of GST On Indian Economy	Dr. Karuna B. Kamble	126
28	Important Challenges And Prosperous Of Indian Economy: Reference To Agriculture Sector	Dr. K.M. Tele	136
29	Economical Challenges In Front Of Indian Government & It's Solutions	Prof. Thombare Sandip Ashok	141
30	Role Of Reserve Bank Of India In Indian Economy	Prof. Take Kishor Bhausahab	144
31	Impact Of GST On The Indian Economy	Prashant Prakash Dhanave	152
32	Agriculture Productivity	Prof. Dr. Deepak Pandharinath Sontakke	156

RUSA, DST, FIST sponsored National Seminar on "Challenges before Indian Economy".

By Department of Commerce and Economics, N.A.C.& S. College, Parner, Dist- Ahmednagar (M.S.)

Introduction to Indian Economy and Problems Faced By It

Prof. Ranjit A. Shinde

Head, BBA-CA Department, New Arts, Commerce and Science College, Parner.

Introduction to Indian Economy:-

The economy of India is characterised as a developing market economy. It is the world's fifth-largest economy by nominal GDP and the third-largest by purchasing power parity (PPP). According to the IMF, on a per capita income basis, India ranked 142nd by GDP (nominal) and 119th by GDP (PPP) per capita in 2018. From independence in 1947 until 1991, successive governments promoted protectionist economic policies with extensive state intervention and regulation; the end of the Cold War and an acute balance of payments crisis in 1991 led to the adoption of a broad liberalisation. Since the start of the 21st century, annual average GDP growth has been 6% to 7%, and from 2014 to 2018, India was the world's fastest growing major economy, surpassing China. Historically India was one of the largest economy in the world for most of the two millennia from 1st until 19th century.

The long-term growth perspective of the Indian economy remains positive due to its young population and corresponding low dependency ratio, healthy savings and investment rates, and is increasing integration into the global economy. The economy slowed in 2017, due to shocks of "demonetisation" in 2016 and introduction of Goods and Services Tax in 2017. Nearly 60% of India's GDP is driven by domestic private consumption and continues to remain the world's sixth-largest consumer market. Apart from private consumption, India's GDP is also fuelled by government spending, investment, and exports. In 2018, India was the world's tenth-largest importer and the nineteenth-largest exporter, India has been a member of World Trade Organization since 1 January 1995. It ranks 63rd on Ease of doing business index and 68th on Global Competitiveness Report. With 520-million-workers, the Indian labour force is the world's second-largest as of 2019. Since India has a vast informal economy, barely 2% of Indians pay income taxes. During the 2008 global financial crisis the economy faced mild slowdown, India undertook stimulus measures (both fiscal and monetary) to boost growth and generate demand; in subsequent years economic growth revived. According to 2017 PricewaterhouseCoopers (PwC) report, India's GDP at purchasing power parity could overtake that of the United States by 2050. According to World Bank, to achieve sustainable economic development India must focus on public sector reform, infrastructure, agricultural and rural development, removal of land and labour regulations, financial inclusion, spur private investment and exports, education and public health.

RUSA, DST, FIST sponsored National Seminar on "Challenges before Indian Economy".

By Department of Commerce and Economics, N.A.C.& S. College, Parner, Dist- Ahmednagar (M.S.)

India's largest trading partners are China, USA, UAE, Saudi Arabia, Switzerland, Germany, Hong Kong, Indonesia, South Korea, and Malaysia. In 2018-19, the foreign direct investment (FDI) in India was \$64.4 billion with service sector, computer, and telecom industry remains leading sectors for FDI inflows. India has free trade agreements with several nations, including ASEAN, SAFTA, Mercosur, South Korea, Japan and few others which are in effect or under negotiating stage. The service sector makes up 55.6% of GDP and remains the fastest growing sector, while the industrial sector and the agricultural sector employs majority of the labour force. The Bombay Stock Exchange and National Stock Exchange are one of the world's largest stock exchanges by market capitalization. India is the world's sixth-largest manufacturer, representing 3% of global manufacturing output and employs over 57 million people. Nearly 70% of India's population is rural whose primary source of livelihood is agriculture, and contributes about 50% of India's GDP.[69] It has the world's seventh-largest foreign-exchange reserves worth \$440 billion. India has a high national debt with 68% of GDP, while its fiscal deficit remained at 3.4% of GDP. However, as per 2019 CAG report, the actual fiscal deficit is 5.85% of GDP. India's government-owned banks faced mounting bad debt, resulting in low credit growth, simultaneously the NBFC sector has been engulfed in a liquidity crisis. India faces high unemployment, rising income inequality, and major demand slump.

India ranks second globally in food and agricultural production, while agricultural exports were \$38.5 billion. The construction and real estate sector is the second largest employer after agriculture, and a vital sector to gauge economic activity. The Indian textiles industry is estimated at \$150 billion and contributes 7% of industrial output and 2% of India's GDP while employs over 45 million people directly. The Indian IT industry is a major exporter of IT services with \$180 billion in revenue and employs over four million people. India's telecommunication industry is the world's second largest by number of mobile phone, smartphone, and internet users. It is the world's tenth-largest oil producer and the third-largest oil consumer. The Indian automobile industry is the world's fourth largest by production. It has \$672 billion worth of retail market which contributes over 10% of India's GDP and has one of world's fastest growing e-commerce markets. India has the world's fourth-largest natural resources, with mining sector contributes 11% of the country's industrial GDP and 2.5% of total GDP. It is also the world's second-largest coal producer, the second-largest cement producer, the second-largest steel producer, and the third-largest electricity producer.

Problems Faced By Indian Economy: Eight Major Problems Faced by the Indian Economy

The following points highlight the eight major problems of the Indian economy. Some of the problems are: 1. Low level of national income and per capita income 2. Vast inequalities in

94 | Page

RUSA, DST, FIST sponsored National Seminar on “Challenges before Indian Economy”.

By Department of Commerce and Economics, N.A.C.& S. College, Parner, Dist- Ahmednagar (M.S.)

income and wealth 3. Predominance of agriculture 4. Tremendous population pressure 5. Massive unemployment and others.

1. Low level of national income and per capita income:

Economic growth of any country can be viewed from its level of national income and per capita income.

It is said that higher the level of national income, higher is the rate of economic growth.

India's net national product (NNP) at factor cost in 2007-08 at 1999-2000 prices stood at Rs 27,60,325 crore. Population during the time stood at 1124 million.

This amounts to saying that per capita NNP came to Rs 24,256 or Rs 2,021 per month. Standards of living of masses are miserably low. Even the basic necessities are beyond the means of the majority of population. Comparing India's per capita income with the other countries of the world, one comes to the conclusion that India is one of the poorest nations of the world.

2. Vast inequalities in income and wealth:

Not only per capita income is low, but Indian economy is also marked by great inequalities in the distribution of income and wealth. In India, as years roll on, inequalities are on the rise. The logical corollary of this inequality is mass poverty. Nearly 60 p.c. of the total population share one-third of India's national income while only rich 5 p.c. of the total population enjoy the same amount of national income.

This inequality widens the problem of poverty. Even in 1972-73, more than 50 p.c. of the total population lived below the poverty line. Thanks to some economic progress it has come down from 36 p.c. in 1993-94 to about 27.5 p.c. in 2004- 05, poverty estimate based on Uniform Recall Period. In short, Indian economy still reels under the vicious circle of poverty.

3. Predominance of agriculture:

Less developed countries live mainly upon agriculture and extractive industries, like mining, fisheries and forests. Predominance of agriculture is explained from the viewpoint of sectorial composition of national income and occupational pattern.

In India, in 1950- 51, more than 55 p.c. of our GDP came from the agricultural sector or the so- called primary sector. In 2007-08, however, the contribution of this sector toward GDP came down to 19.4 p.c.

The contributions of the secondary and tertiary sectors were 24.9 p.c. and 55.7 p.c., respectively. Thus, even after 58 years of planning, agriculture alone contributes less than one-fifth of our national income. Occupational structure also tells a story of predominance of the agricultural sector and the backwardness of the industrial sector.

In India, 52 p.c. of the total population was engaged in agriculture in 2004-05. Though agriculture occupies a predominant position in India, it is still backward.

RUSA, DST, FIST sponsored National Seminar on "Challenges before Indian Economy".

By Department of Commerce and Economics, N.A.C.& S. College, Parner, Dist- Ahmednagar (M.S.)

4. Tremendous population pressure:

In LDCs, the rate of growth of population is very high. So far as the size of population is concerned, India ranks second next only to China (1312 million in 2006). India's population is now 1110 million in 2006-07. During the decade of 1991, the growth rate of population in India was 1.61 p.c. per annum, as compared to 0.7 p.c. growth rate of population of developed countries.

High birth rate (23.5 per 1000) coupled with low death rate (7.5. per 1000 in 2005-06) is the genuine cause for population explosion in India. In the 20th century, India's population went up by 5 p.c. as against 3 p.c. increase in the world's population as a whole.

5. Massive unemployment:

In LDCs, not only natural resources are under-utilised but also a massive wastage occurs in the case of manpower resources. Slow economic growth rate on the one hand, and rapid growth of population on the other hand, has accentuated the problem of unemployment in India.

Between 1971 and 1999, the number of unemployed in India increased by 10 times though the number of job-seekers increased by 2.5 p.c. annually; but the employment possibilities increased by a modest rate of 1.8 p.c. Number of registered job-seekers in 2006-07 stood at 40.7 million. Unemployment rate has been rising persistently since the days of economic reforms began. It rose from 1.96 p.c. in 1993-94 to 2.39 p.c. in 2004-05.

However, employment growth in 2004-05 that stood at 2.89 compared to 0.98 p.c. in 1999-2000 is an encouraging development. But employment growth in recent decades is not commensurate with the labour force growth rate. What we experience now is the 'jobless growth'.

The rate of growth of employment in the organised sector came to a negative of 0.31 p.c. during 1994-2005 as compared to 1.20 p.c. in 1983-1994. Some people call it 'job loss growth'.

Not only this, Indian agriculture exhibits a considerable amount of underemployment and disguised unemployment. In the urban areas also, we find disguised unemployment. It is somewhat tragic as well as paradoxical that, despite massive investment made during the plan period, unemployment problem has assumed a gigantic proportion. This amounts to huge wastage of human capital.

6. Scarcity of capital and low rate of capital formation:

As people in LDCs are poor, their capacity to save is low. This results in a low rate of capital formation. That is why development economists suggest that to break the vicious circle of poverty it is necessary to push up the rate of investment. Since India is a capital-poor country, capital per head is low. This scarcity of capital causes overall backwardness of the Indian economy.

96 | P a g e

RUSA, DST, FIST sponsored National Seminar on “Challenges before Indian Economy”.

By Department of Commerce and Economics, N.A.C.& S. College, Parner, Dist- Ahmednagar (M.S.)

In 1950-51, net savings and net investments stood at slightly more than 6 p.c. and these two increased to 14.8 p.c. and 16 p.c., respectively in 2001-02. The position, however, in recent times has improved a lot. These two figures increased to 27.1 p.c. and 28.4 p.c. of NDP in 2006-067. This is an encouraging development for the Indian economy.

Along with the low volume of physical capital, human capital formation is also low. As per 2001 Census, 34.62 p.c. of the total population at that time was illiterate. The literacy rate has gone up to about 64.8 p.c. by 2001—of course, by mathematical jugglery.

Mass illiteracy acts as an impediment to India's economic development. India has the dubious distinction of having largest number of illiterate population (304 million) in the world. India has an adverse sex ratio with only 933 women per 1,000 men in 2001.

7. Underdeveloped infrastructure:

Being an LDC, India's infrastructural facilities or economic and social overheads of capital are inadequate. It consists of (a) transport and communications, (b) energy, (c) finance, housing and insurance, (d) science and technology, and (e) health, education, etc.

Availability of these infrastructures creates the conditions for favourable growth. The superstructure of an economy largely depends on the availability of infrastructural facilities.

As far as social and economic overheads are concerned, India is poor. It is indeed true that her railway and road networks are comparable to the developed nations. But her demand for infrastructural facilities and services outpace their supplies. Per capita energy use (oil equivalent) of an Indian in 2004 was 531 kg vis-a-vis USA's 7,921 kg. Even China's per capita energy use was higher (1,242 kg.) than India's.

Compared to other countries, India is poor in information technology. In 2005, the use of personal computers per 1,000 Indians was as low as 16 as against 762 per 1,000 US people. India's health expenditure as a percentage of GDP was 1.39 p.c. in 2007-8 over the USA's 15 p.c. of GDP.

Thus, India's social infrastructural facilities are not only inadequate compared to the needs, but also awfully low compared to different countries of the world.

8. Low level of technology:

Due to illiteracy, use of advanced or sophisticated technology is rather an exception in India. Because of the limited growth of technological institution, we are forced to use primitive methods of technology whose productivity is low.

Though modern industrial sectors employ advanced technology, village industries still employ old and hackneyed methods even in the age of modern science and globalized world. This is nothing but technological dualism that persists in LDCs like India. Truly speaking, low productivity of Indian labour is explained in terms of low level of technology.

RUSA, DST, FIST sponsored National Seminar on "Challenges before Indian Economy".

By Department of Commerce and Economics, N.A.C.& S. College, Parner, Dist- Ahmednagar (M.S.)

From the above discussion, we can conclude that all the characteristics of LDCs are found in India. No doubt, during the planning era, she has made progress in different directions. Still, considering the needs of the country, it is inadequate.

Indian economy is characterised by low per capita income, widespread poverty, massive unemployment, gigantic rise in population, and so on. So, India is an underdeveloped country. India is one of the poorest nations of the world. Her position is worse compared to even some African countries!

Courtesy

<http://www.economicdiscussion.net/>

<https://www.wikipedia.org>

39. Challenges before Agricultural Sector in India



CONTENTS

Sr.No.	Title	Page no.
a.	BPHE Society	13
b.	Institute of Management Studies (Career Development & Research	15
c.	Director's Message	18
"Challenges in Multitudinal Management Orbits"		
Sub-theme :General Management		
1.	NEED OF CONSIDERING JOB ROTAION PRACTICES FOR EMPLOYEE RETENTION AND IMPROVING ORGANIZATIONAL PERFORMANCE Abhijit Kulkarni	20
2.	STUDY OF NATIONAL HORTICULTUE BOARD BhagwatYadav	36
3.	A STUDY ON USAGE OF DIGITAL PAYMENT GATEWAY IN RURAL INDIA W.S.R.T. AHMEDNAGAR OF MAHARASHTRA STATE Alka Dhongade	42
4.	ANALYTICAL STUDY OF TRENDS OF MBA ASPIRANTS IN MAHARASHTRA FOR MANAGEMENT COURSE CET Hari Shankar Rai	47
5.	IS BUSINESS MANAGEMENT UPLIFTS ECONOMY.....YES CASE STUDY- JSW TORNAGALLU BELLARY DIST. Rafiya	59
6.	INNOVATIVE STUDENT CENTRIC SERVICES OFFERED BY ADMINISTRATION DEPARTMENT IN A MANAGEMENT INSTITUTE : A CASE STUDY W.R.T. IMSCD&R, AHMEDNAGAR Mrs. Sharayu Kulkarni, Mr. Narendra Kadam and Mr. Mahesh Dixit	68
7.	LIBRARIAN ON THRUST OF IMPARTING INFORMATION LITERACY PROGRAMMES: A CASE STUDY Swati Barnabas,VasudhaDeshpande, JitinAdhav, SirajMulani	75
Sub-theme :Marketing		
8.	MARKETING INFORMATION SYSTEM: OPPORTUNITY AND CHALLENGES (M&IS) Mayur Desai	95
9.	CHALLENGES FACED IN MARKETING BRANDED PRODUCTS IN RURAL AND URBAN MARKET Mousami J. Bhandari (Dudhedia) and . Sunita S. Thube	104
10.	A PERCEPTION OF STUDY OF PASSENGERS ABOUT SERVICE QUALITY OF MSRTC WITH SPECIAL REFERENCE TO AHMEDNAGAR DISTRICT	110

CHALLENGES FACED IN MARKETING BRANDED PRODUCTS IN RURAL AND URBAN MARKET

Dr. Mousmi J. Bhandari (Dudhedia)

Dept. of Commerce
Ahmednagar College, Ahmednagar
mousmibhandari @ gmail.com.
Mob.No.- 9423177780

Prof. Sunita S. Thube

Dept. of B.B.A. CA
New Arts, Commerce & Science college,
Parner.
thube.sunita@gmail.com
Mob.No.- 7588168995

ABSTRACT :- This article provides clear understanding of the consumer mindset towards Branded products. It also focuses on some issues and emerging trends in sales and customer attraction which enable improvements in branded products. In the recent years rural market have acquired significance and attract the attention of markets as the population of India is increasing in rural and urban area. The over all growth of economy has resulted in increase in the purchasing power of the customers. Due to green revolution the rural areas are consuming a large quantity of industrial and manufactured products. Due to untapped market, increase in disposable income, literacy, purchasing power, changes in life style, awareness of hygiene, habits has changed the selection of goods. Hence rural market has become a favorite destination for every marketers. Rural market is developed by rising purchasing power, changing consumption pattern, increase in information, technology and increased government initiatives to boost the rural economy. Hence companies face many challenges in faced in Marketing branded Product in rural & Urban market.

Key words :- Indian rural market, customers, urban GNP, strategies, brand awareness.

Objectives :-

1. To study the present scenario of rural market in India.
2. To determine about the rural urban consumers preference toward branded products.
3. To study challenges faced in Marketing branded Product in rural & Urban market

Research Methodology :- Being an explanatory research it is based on secondary data of journals, articles, newspapers and magazines. The accessible secondary data is intensively used.

Introduction :- Since the 1980's the rural market was used to attract marketers in Indian consumer market. **Rural market** according to the census of India village with clear surveyed boundaries not having a municipality corporation or board, with density population not more than 400 sq.km and with at least 75% of the male working population engaged in agriculture activities would qualify as rural. According to this definition there are 6,38,000 villages in India, among them 0.5% has a population about 10,000 and 2% have population between 5,000 and 10,000 around 50% has a population less than 200. About 285 millions live in urban India were as 742 millions reside in rural areas. The number of middle income and high income households in rural India is expected to grow from 46 millions to 59 millions. The size of rural market has been going at 5 times the growth of the urban market. Our national is classified in around 450 districts and approx 6,30,000 village.

Before 1960's :- Indian market was unorganized where "Baniyas and Mahajans" dominate the market. Rural market was called as agriculture marketing because agriculture produces like food grains and industries like cotton, oil seeds, occupied primary attention.

From 1960 to 1990 :- Green revolution took place in this year scientific and technological methods were uses. Agencies like khadi and village industries commissions bloomed and government paid attention to promote these products.

After mid 1990 :- In this period India's industrial sector had gain strength and maturity with the support and development programs held by centre and state government the GNP increased. Rural area made progress socially and economically and emerges as a new market. Hence rural marketing was considered different from agriculture marketing , every year bring some change with era of Globalization. In Indian context we seem changes at business, consumers, strategies, investments or may other manners. It is considered that "**the customer is king**".

Marketing is not a new phenomenon in the present era. Marketing plays important role in the growth and survival of an enterprise. The behavior of consumers are changing due to change in market, tastes, attitudes, social behavior brand awareness, hygiene etc. positive effect of brand building measures through higher sales in the rural areas which leads to modification of consumers behavior was found. There is stiff competition in Urban Areas. The Urban market is getting saturated and thus is unable to provide the much needed market to many companies and is search of greener pastures many of these

105

companies are now targeting the rural market. The rise of India's consumer Market predicts that by 2025 India will become world fifth largest consumer market. This provides tremendous opportunities as well as numerous challenges to be conquered. Indian market is highly fragmented market where as half of market is flooded with unbranded, unpackaged home made products.

Educated customers appreciate products with branded ingredients and are willing to pay a higher price for an ingredient branded product. The absolute profit made on packed and branded products is relatively small but as they sell in large quantities the cumulative profit goes on increasing.

As per census of India 2011 following table gives the explanation of total population

Table - 1

	2001 (in crore)	2011 (in crore)	Difference (crore)
India	102.9	121.0	18.1
Rural	74.3	83.3	9.0
Urban	28.6	37.7	9.1

Source - Census of India 2011

The above table shows that rural population has been increased by 9% from 2001 to 2011. This shows greater opportunities for marketers. Difference between rural and urban consumers always exists in India. Most of Indian rural consumers are illiterate and poor. Due to illiteracy it is difficult to identify brand differences and read basic text on packages. The products which are sold loose, gives high competition to branded sealed products. In rural area the income is not fixed this makes rural customer to buy small quantities. Small quantity products and good credit system is provided for the rural customers. The scenario of rural area is changing. Due to increase in disposable income and literacy level rural customers demand branded products. Family members living in rural area do more expenses on wedding, pilgrimages, construction and consumptions. Rural customers use durable and non-durables and pay right price for right products.

People in rural India has cash in hand and they are not bounded by loans and EMI. Hence this is the right time to penetrate into rural market. The saving to income percentage in rural area is 30% higher than urban area.

A branded companies sells a good with well wrapped, attractive packing and colourful print to attract customers. While unbranded and unpacked products are indistinguishable from those of competitors marketing of packed and branded produce adds a brand value to products. Which enables sellers to charge

106

higher prices for their products. In this situation the product is same but the demand by rural and urban customers may change.

It is clear that penetration rate in rural market is low as compared to urban market. This gives an excellent opportunity for the industry players in form of vastly untapped market following are the challenges in Marketing branded Product in rural & Urban market

1) Challenges :- It is a challenge full task to fulfill all the requirements of customers. The test and choice of rural and urban customers are different but one products should be preferred by both the customers.

2) Road and Transportation problem :- Transportation is required for movement of product from industry to dealers, from dealers to customers in remote villages. The transportation facilities are poor in rural area. 80% of villages have kuccha roads. Hence it is not possible for marketer to access the rural market. Where as traffic and parking is the main problem is urban areas.

3) Ware housing / Godown problems :- Warehouse / godown is necessary because of time gap between consumption and production of commodities. Agricultural commodities are produced seasonally but they are demanded over the year so there is need to store them. In rural area there is lack of public as well as private warehousing due to increase in population there is decrease in warehouse. Also the cost of godown goes on increasing.

4) Underdeveloped people and underdeveloped market :- People living in rural society are underdeveloped. New modern technology has tried to develop the people and markets in rural areas. But the technology has made very less impact in rural areas. Where as requirement of well trained and experienced people is the shortage in urban area.

5) Inadequate media coverage :- Television, news paper, mobile etc. are good source to communicate the message to rural people and best source of publicity and marketing a product. But media have lots of problem in rural areas. Due to non availability of power as well as television sets, majority of rural population cannot get the benefits of various media. Due to quality knowledge of media many misuse or froads are done in urban area.

6) Many languages create problem :- India is a country of many language. Language becomes barrier in effective communication in the market efforts. The number of languages vary from state to state, region to region and district to district etc. this problem is faced equally in rural and urban area.

7) **Low level of literacy** :- Poor quality of literacy rate in rural area as compared to urban areas. Lack of literacy creates communication problem. Print media is not effective so low level of literacy is common challenge for marketers in rural and urban area.

8) **Seasonal demand** :- Agriculture is the main source of income of the people in rural area. This creates significant role in the demand of commodities. Agriculture depends on monsoon season so buying capacity of rural consumers varies. Many rural are not connected by rail and air transports. Kuccha roads becomes unserviceable during monsoon season. Hence seasonal demand is major problem of rural market. Where as pick seasons in summer wedding and festivals creates demand for the commodities in urban area.

Hence rural retailing provides total solution to farmers.

Conclusion :- The study concluded that rural and urban market play a vital role as it provides great opportunities. Rural market has become a favorite destination for every marketers. The rural market is developed by rising purchasing power, changing consumption pattern, increase in information, communication technology, improving infrastructure and increased government initiatives to boost the rural economy. Hence rural India offers new opportunities which companies can tap for their growth and development. However companies face many challenges in Marketing branded Product in rural & Urban market

Reference :

1. Kotni V V D P (2012) prospect and problems of Indian rural markets. Zenith international journal of business economics and management research 2(3) 200-213.
2. Kumar A Hagagi 5(2011). Rural market in India some opportunities and challenges. International journal of exclusive management research 1(II), 1-15.
3. Wath, M. Agarwal P (2011) Rural marketing in India corporate world: issue and challenges 1(4), 750-755.
4. Census of India 2011.
5. Rural Urban Distribution of population census of India 2011. Dr. C. Chandramouli, Registrar General and census commissioner India, ministry of home affair <http://censusindia.gov.in/government of India>.

6. www.crmt.net

7. <https://pdfs.semanticscholar.org>

8. Norris, D.G. (1992) Ingredient branding. A strategy option with multiple beneficiaries. *Journal of consumer marketing* 9, pp-19-31.

40. Structural and magnetic characterization of multiferronic Bismuth Ferrite nanoparticles by sol gel method

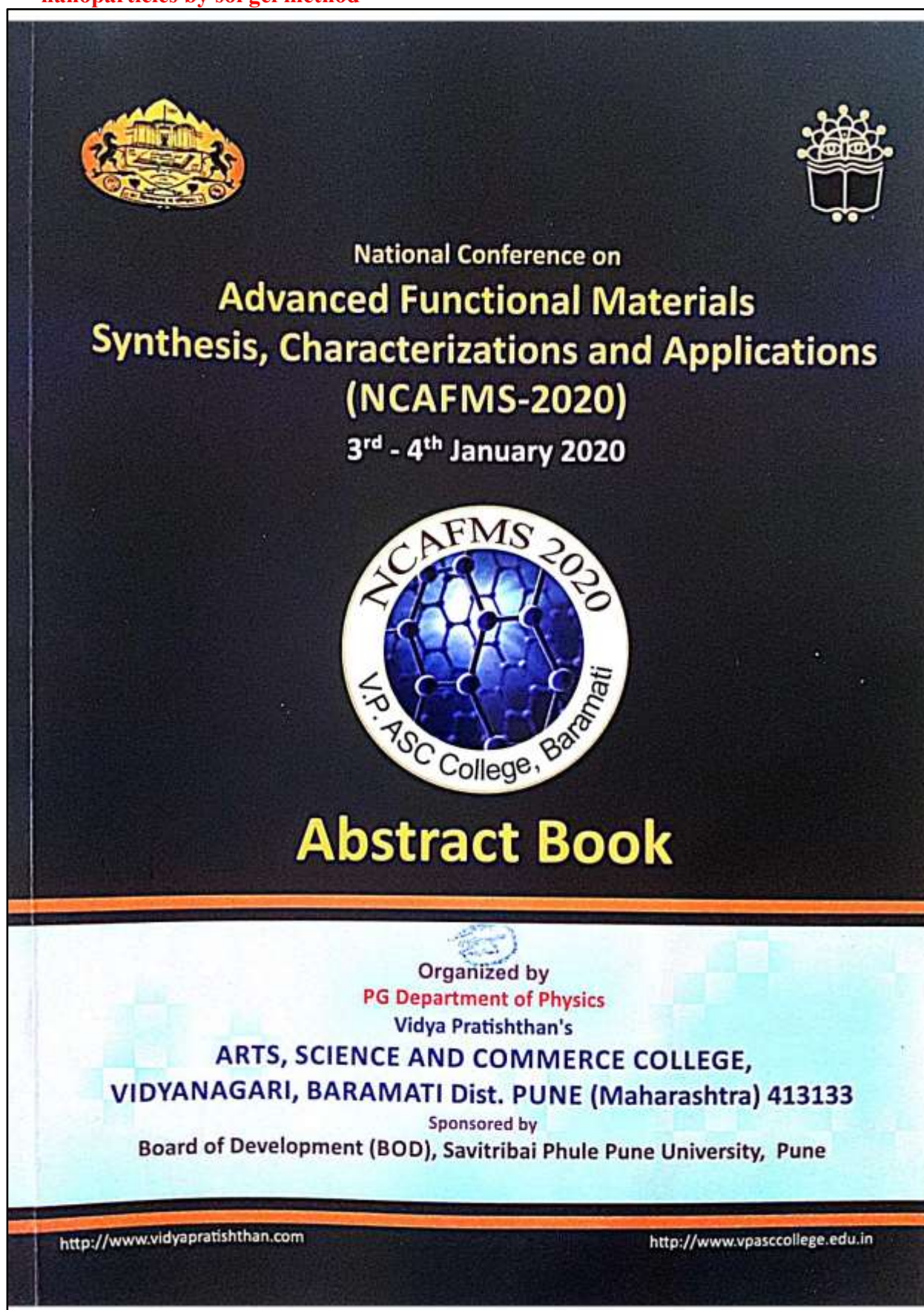



PP-52

Structural properties of Al doped Cd-Co Ferrite

Deshmukh P. B.

Department of Physics, Jijamata College of Science and Arts, Bhende Bk. Tal- Newasa, INDIA

Ferrite samples with general formula $Cd_xCo_{1-x}AlFe_2O_4$ ($x=0, 0.1, 0.2, 0.3, 0.4, 0.5$) were prepared by standard ceramic techniques. The samples were characterized by XRD, SEM and VSM techniques. A single phase F.C.C. structure was confirmed by X-ray diffraction. X-ray analysis showed that the lattice parameter 'a' increases with increasing x. X-ray density exhibit similar behavior. The Bragg peaks of XRD patterns were used to determine the possible cation distribution among the Tetrahedral (A) and Octahedral [B] sites. X-ray intensity calculations indicate that Cd^{2+} and Al^{3+} ions occupy tetrahedral (A) and octahedral [B] sites respectively, while Fe^{2+} ions occupy both tetrahedral (A) and octahedral [B] sites.

Corresponding Author: pbmukh@gmail.com

PP-53

Synthesis and Characterization of Zinc Doped Magnesium Ferrite Nanoparticles

S.A.Kadam, M.A.Shinde, M.G.Jagtap, P.V.Patil*

P.G. Department of Physics, Vidya Pratishthan ASC College Baramati. (Pune) 413133

The synthesis and studies on the properties of $Mg(x)Zn(1-x)Fe_2O_4$ ferrite nano particles reported in the present work. With an attempt for industrial scale synthesis, ferrite nano particles are prepared by sol gel auto combustion method to fulfill the large scale demand for variety commercial applications. The structural and magnetic properties of $Mg(x)Zn(1-x)Fe_2O_4$ studied as a function of composition and particle size by x-ray diffraction, Fourier Transform Infrared Spectroscopy, Magnetic susceptibility measurement and VSM. Variation in concentration also been studied with lattice parameter and grain size measurement. Lattice parameter was found to increase with Zn concentration and this may be due to the larger ionic radius of the Zn^{2+} ion. The cation redistribution on tetrahedral and octahedral sites due to change in sintering temperature also been studied. VSM studies show that the samples prepared in basic medium have more ferrimagnetic nature as compared to those prepared in acidic medium. Magnetization increases with the increase in degree of inversion (transfer of Fe^{2+} ions from octahedral to tetrahedral sites) in the particles of smaller size FNP's.

*Author for correspondence

PP-54

Structural and Magnetic Characterization of Multiferroic Bismuth Ferrite Nanoparticles by sol-gel Method

S.L.Kadam¹, V.B. Sherkar^{1*}, V.P.Deore¹, G.M. Repale¹, K. M. Sable¹

Post Graduate Department of Physics, New Arts, Commerce and Science College, Parner, Tal- Parner, Dist.-Ahmednagar. MH-414302

In the present work of multiferroic bismuth ferrite (BFO) nanoparticles synthesized by sol-gel auto combustion technique by chemical route followed by thermal treatment calcined at 300 °C and 400 °C. X-ray diffraction analysis, scanning electron microscope, UV-Vis spectroscopy and vibrating sample magnetometer were carried out at room temp to study the structural and magnetic properties of synthesized products. VSM was utilized to measure the size dependent magnetic behaviours of prepared nanoparticles. XRD demonstrate that BFO nanoparticles crystallize in a distorted rhombohedral perovskite structure with space group of R₃C. It is found that BFO nanoparticles crystallized at annealed 300 °C, scanning electron microscope extracting their surface morphology and their crystallographic structure and reveal that the size of the BFO nanoparticles are distributed in the range of 80-200 nm which is in well agreement. The UV-Vis absorption spectra display the band gap of BFO nanoparticles is 2.21 eV. It was also observed that the magnetic properties were directly related to the size and temperature and crystalline size increased.

Keywords: Bismuth ferrite, Nanoparticles, X-ray diffraction, SEM, VSM

*Corresponding Author: sherkarvishal@gmail.com

41. Electrochemical synthesis of CuS thin film for supercapacitor application

Fourth International Conference on Advances in Materials Science (ICAMS- 2020): 20th – 21st January 2020

PP-87

Electrochemical Synthesis of CuS Thin Film for Supercapacitor Application

S. L. Kadam¹, R. N. Bulakhe², R. A. Kadam¹, M. A. Yewale^{1,*}

¹Post Graduate Department of Physics, New Arts, Commerce and Science College, Parner Tal -
Parner, Dist.- Ahmednagar, MH-414302.

²School of Chemical Engineering, Yeungnam University- 712749, South Korea

¹Department of Physics, Janata Arts and Science College, Rui Chattishi, Ahmednagar

Email: maneshphd@gmail.com

Abstract

In the present work, Walnut like copper sulfide is prepared via a facile single-step potentiostatic electrodeposition method on conducting stainless steel substrate. The Walnut like morphology of copper sulfide thin film lies of microplates and further microplates converted to nanogranules, by means of a change in deposition time and thickness. Copper sulfide thin film electrode reveals a specific capacitance of 132 F g^{-1} at 50 mA cm^{-2} . The film thickness is changes with deposition time. The films acquire maximum thickness 610 nm for 25 minute of deposition. XRD analysis reveals that the CuS thin films is polycrystalline nature and the crystallite size is 29 nm. The peak at 612 cm^{-1} in the FTIR spectra confirms the formation of CuS. The wettability study shows the hydrophilic nature. The contact angle of water with CuS electrode is 66° . The charge transfer resistance of CuS electrode is 5.66Ω .

Keywords: CuS thin films, Electrodeposition, XRD, SEM, EDAX, Supercapacitor.

ADVANCES IN MATERIALS SCIENCE

20th - 21st JANUARY 2020

Post-Graduate Department of Physics, Rajee Ramrao Mahavidyalaya, Jath, Dist: Sangli, Maharashtra, India 180

Fourth International Conference on Advances in Materials Science (ICAMS- 2020): 20th – 21st January 2020

“Dissemination of Education for Knowledge, Science and Culture”
- Shikshanmaharshi Dr. Bapuji Salunkhe

**Fourth International Conference on
Advances in Materials Science
(ICAMS- 2020)**

20th – 21st January 2020

Shri Swami Vivekanand Shikshan Sanstha, Kolhapur's
Post-Graduate Department of Physics,
Raje Ramrao Mahavidyalaya, Jath,
Dist: Sangli, Maharashtra, India

Dr. Sanjay S. Latthe
Convenor

Dr. A. K. Bhosale
Co-Convenor

Dr. S. R. Kokare
Secretary

Dr. V. S. Dhekale
Principal

Post-Graduate Department of Physics, Raje Ramrao Mahavidyalaya, Jath, Dist: Sangli, Maharashtra, India

1

42. Synthesis Characterization and Application of ZnO by Mechanochemical method

Raman Memorial Conference - 2020

PP-27

Synthesis, Characterization and Application of ZnO by Mechanochemical Method**S. D. Aher[#], S. L. Kadam^{**}, R. B. Kharade[#] and P. R. Abhale[#]**[#]Department of Physics,
New Arts, Commerce and Science College, Parner, Dist- Ahmednagar- 414302.**Abstract**

Zinc Oxide nanoparticles (ZnO) were successfully synthesized by Mechano-chemical method [1]. Synthesized ZnO nanoparticles were characterized by X-ray diffraction (XRD), scanning electron microscopy (SEM), UV-visible spectroscopy and Energy dispersive X-ray spectroscopy (EDX). XRD data is in agreement with Satyanarayana et. al. [2]. The morphology, size and structure of these ZnO nanoparticles were investigated using SEM. The optical properties of the samples were investigated by measuring the UV-VIS absorption at room temperature. The percentage of Zinc and Oxygen are determined by EDX. SEM images are in agreement with the XRD data which shows average size of the nanoparticles about 25nm.

**Figure:** SEM of ZnO Nanoparticles**Keywords:** zinc oxide, mechano-chemical method, nano powder, characterization.**#: Presenting author:** snehalaher07@gmail.com***: Corresponding author:** mr.sukadeo@rediffmail.com**Acknowledgement:**

We would like to thank Principal Dr. R. K. Aher of our college for permitting us to use all facilities available in the college during this work.

References:

1. Ameer Azam, Faheem Ahmed, Nishat Arshi, M. Chaman and A.H. Naqvi, International Journal of Theoretical & Applied Sciences. (2009).
2. Satyanarayana Talam, Srinivasa Rao Karumuri and Nagarjuna Gunnam; International Scholarly Research Network ISRN Nanotechnology, Article ID 372505(2012).

ABSTRACT BOOK**26TH RAMAN MEMORIAL CONFERENCE***"Novel Materials for a sustainable future"**"Celebrating the 150th Anniversary of the Establishment of the Periodic Table"***14th-15th FEBRUARY 2020**

**Organized By,
Research Students,
Department of Physics,
Savitribai Phule Pune University,
Pune - 411007**

43. Internet of Things with Blockchain

New Arts, Commerce and Science College, Ahmednagar

E-ISSN 2348-1269, P-ISSN 2349-5138



Internet of Things with Blockchain

Prof. Kale S.S.
Prof. Narsale B.S.

supriya.kale740@gmail.com
narsale_bs@rcdiffmail.com

New Arts, Commerce and Science College, Ahmednagar

Abstract

Blockchain technology enables distributed public ledgers that hold immutable data in a secure and encrypted way and ensure that transactions can never be altered. While Bitcoin and other cryptocurrencies are the most popular examples of blockchain usage, this “distributed ledger technology” (DLT) is finding a broad range of uses. Data storage, financial transactions, real estate, asset management and many more uses are being explored. While the block in the example above is being used to store a single purchase from Amazon, the reality is a little different. A single block on the blockchain can actually store up to 1 MB of data. Depending on the size of the transactions, that means a single block can house a few thousand transactions under one roof.

Keyword- Internet of things(IoT) , Distributed Ledger Technology” (DLT)

What is Blockchain?

Blockchain is a database that maintains a continuously growing set of data records. It is distributed in nature, meaning that there is no master computer holding the entire chain. Rather, the participating nodes have a copy of the chain. It’s also ever-growing — data records are only added to the chain. A blockchain consists of two types of elements:

- Transactions are the actions created by the participants in the system.
- Blocks record these transactions and make sure they are in the correct sequence and have not been tampered with. Blocks also record a time stamp when the transactions were added.

What are Some Advantages of Blockchain?

The big advantage of blockchain is that it’s *public*. Everyone participating can see the blocks and the transactions stored in them. This doesn’t mean everyone can see the actual content of your transaction, however; that’s protected by your private key. A blockchain is *decentralized*, so there is no single authority that can approve the transactions or set specific rules to have transactions accepted. That means there’s a huge amount of trust involved since all the participants in the network have to reach a consensus to accept transactions. Most importantly, it’s *secure*. The database can only be extended and previous records cannot be changed (at least, there’s a very high cost if someone wants to alter previous records).

New Arts, Commerce and Science College, Ahmednagar

E-ISSN 2348-1269, P-ISSN 2349-5138

How does it Work?

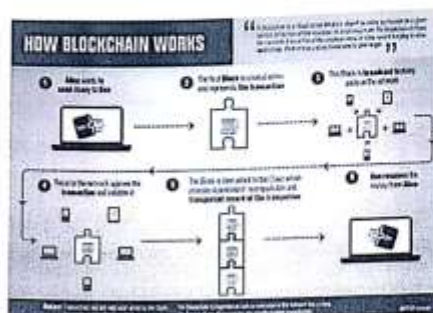

When someone wants to add a transaction to the chain, all the participants in the network will validate it. They do this by applying an algorithm to the transaction to verify its validity. What exactly is understood by "valid" is defined by the blockchain system and can differ between systems. Then it is up to a majority of the participants to agree that the transaction is valid.

A set of approved transactions are then bundled in a block, which gets sent to all the nodes in the network. They in turn validate the new block. Each successive block contains a hash, which is a unique fingerprint, of the previous block.

The Blockchain and IoT

Blockchain technology is the missing link to settle scalability, privacy, and reliability concerns in the Internet of Things. Blockchain technologies could perhaps be the silver bullet needed by the IoT industry. Blockchain technology can be used in tracking billions of connected devices, enable the processing of transactions and coordination between devices; allow for significant savings to IoT industry manufacturers. This decentralized approach would eliminate single points of failure, creating a more resilient ecosystem for devices to run on. The cryptographic algorithms used by blockchains, would make consumer data more private.

The ledger is tamper-proof and cannot be manipulated by malicious actors because it doesn't exist in any single location, and man-in-the-middle attacks cannot be staged because there is no single thread of communication that can be intercepted. Blockchain makes trustless, peer-to-peer messaging possible and has already proven its worth in the world of financial services through cryptocurrencies such as Bitcoin, providing guaranteed peer-to-peer payment services without the need for third-party brokers. The decentralized, autonomous, and trustless capabilities of the blockchain make it an ideal component to become a fundamental element of IoT solutions. It is not a surprise that enterprise IoT technologies have quickly become one of the early adopters of blockchain technologies. In an IoT network, the blockchain can keep an immutable record of the history of smart devices.

ICIoT 2019

New Arts, Commerce and Science College, Ahmednagar

E-ISSN 2348-1269, P-ISSN 2349-5138

IoT

The Blockchain functions as a distributed transaction ledger for various IoT transactions

Universal digital ledger

Register new devices

Authenticate remote users

Barter power with other appliances

Run checklist for automobile safety

This feature enables the autonomous functioning of smart devices without the need for centralized authority. As a result, the blockchain opens the door to a series of IoT scenarios that were remarkably difficult, or even impossible to implement without it.

By leveraging the blockchain, IoT solutions can enable secure, trustless messaging between devices in an IoT network. In this model, the blockchain will treat message exchanges between devices similar to financial transactions in a bitcoin network. To enable message exchanges, devices will leverage smart contracts which then model the agreement between the two parties. In this scenario, we can sensor from afar, communicating directly with the irrigation system in order to control the flow of water based on conditions detected on the crops. Similarly, smart devices in an oil platform can exchange data to adjust functioning based on weather conditions.

Conclusion

Using the blockchain will enable true autonomous smart devices that can exchange data, or even execute financial transactions, without the need of a centralized broker. This type of autonomy is possible because the nodes in the blockchain network will verify the validity of the transaction without relying on a centralized authority. In this scenario, we can envision smart devices in a manufacturing plant that can place orders for repairing some of its parts without the need of human or centralized intervention. Similarly, smart vehicles in a truck fleet will be able to provide a complete report of the most important parts needing replacement after arriving at a workshop. One of the most exciting capabilities of the blockchain is the ability to maintain a duly decentralized, trusted ledger of all transactions occurring in a network. This capability is essential to enable the many compliance and regulatory requirements of industrial IoT applications without the need to rely on a centralized model.

References

- 1) <https://www.investopedia.com/terms/b/blockchain.asp>
- 2) <http://www.cio.com/article/3027522/internet-of-things/beyond-bitcoin-can-the-blockchain-power-industrial-iot.html>

ICIoT 2019

44. ME output in magnetoelectric composites

National e-Conference on Recent Advances in Materials Science & Nanotechnology (NCRAMSN-2020); 1st & 2nd August 2020

AB-32

ME OUTPUT IN MAGNETOELECTRIC COMPOSITES

S. L. Kadam, M.A. Yewale

PG Department of Physics, New Arts, Commerce and Science College, Parner, Tal. Parner,

Dist. Ahmednagar-414302 (M.S.)

email - mr.sukadeo@rediffmail.com

Abstract:

Magnetoelectric composites of ferrite and ferroelectric phase having the general formula $XBa_{0.8}Pb_{0.2}TiO_3 + (1-X) Ni_{0.7}CO_{0.3}Fe_2O_4$ (where X is mole fraction of components that varies as 0.80, 0.60 and 0.40) were prepared by ceramic method. The presence of constituent phases was confirmed by X-ray diffraction technique. The average grain size was determined by using SEM. The variation of dielectric constant and $\tan\delta$ with frequency in the range 20Hz - 1MHz was studied. The variation of loss tangent and dielectric constant with temperature at fixed frequencies of 1 kHz, 10 kHz, 100 kHz and 1 MHz was also studied. The static magnetoelectric voltage coefficient was measured as a function applied magnetic field. The changes were observed in dielectric properties as well as in ME output with variation in molar fraction of constituent phases. A maximum ME composites may be useful in preparing devices such as magnetic sensors and cables, etc.

Keywords: Composites, ME output, Dielectric properties

NCRAMSN-2020

Department of Physics, Yeshwantrao Chavan College, Sillod Dist. Aurangabad, Maharashtra, India. 62

45. Optimization of crystal violet Dye for decolorization using Aluminum oxide nanoparticles

PP-16

Optimization Of Crystal Violet Dye For Decolourization Using Aluminium Oxide Nanoparticles

V. P. Dhawale¹, S. K. Aher², S. D. Kulkarni³

¹Post Graduate Department of Physics, New Arts Commerce and Science College, Parner, Ahmednagar, India

²Post Graduate Department of Physics, New Arts Commerce and Science College, Parner, Ahmednagar, India

³Post Graduate Department of Environmental Science, New Arts Commerce and Science College, Ahmednagar, India

Email address: vijaya.dhawale2009@gmail.com.

Abstract

Aluminum oxide nanoparticles were prepared by sol-gel method using ethanolic solution of $AlCl_3$, 25% NH_3 along with capping agent polyvinyl alcohol (PVA). Synthesized nanopowder was applied for decolourisation of crystal violet dye. Variable parameters were concentration of dye, pH of a dye and dose of nanoadsorbent. It was observed that, decolourisation decreases with increase in dye concentration at same pH of dye and same dose of adsorbent. Also it was observed that, at same dye concentration and same pH value, with increase in amount of nanoadsorbent decolourisation remains approximately constant for smaller dose of 10mg/l dye and decreases for 15 mg/l dye concentrations. Therefore we can say that dose was optimized at 10 mg dye concentration, at 7.0 pH and dose 100 mg of adsorbent. The properties of synthesized nanoparticles were investigated by using UV-Visible spectroscopy, XRD, FTIR, SEM, EDAX, DTA and TGA. Raman spectroscopy and TEM. From UV-visible spectra, band gap was calculated and it was found to be 3.31 eV. Average crystal size of $\alpha-Al_2O_3$ nanoparticles from XRD peaks found to be 25 nm having rhombohedral structure. FTIR spectra revealed that functional groups (O-Al-O) are present. SEM image shows distribution pattern of $\alpha-Al_2O_3$ nanoparticles. Chemical composition of $\alpha-Al_2O_3$ nanoparticles was confirmed from EDAX spectroscopy measurement. Raman spectra showed crystalline nature of $\alpha-Al_2O_3$ nanoparticles. The % weight loss with temperature of TGA curve shows that nanoparticle formation temperature is 762^oc and transition temperature is 800^oc with one step loss of 77%. The DTA curve shows endothermic reaction attributed to moisture loss and to hydroxyl loss from the decomposition of hydrated aluminum chloride and aluminum hydroxide. Synthesized aluminum oxide nanoparticles were applied successfully in waste water treatment as a adsorbent.

Keywords: Adsorbent, optimization, decolourisation, crystal violet dye

46. Connecting Past With Present Mathematics Education

Connecting past with present Mathematics Education

Prof. Sonawane R.D.

Department of Mathematics

New Art's Commerce and Science College, Parner Dist. –Ahmednagar

Email Id-rdsmaths9@gmail.com

ABSTRACT

Mathematics is one of the most important subject in all discipline without Mathematics we can not imagine . Since in all Science Engineering, Technology, Social Science, daily life Mathematics plays important role. Basic Mathematics play very important role , these are building blocks for present research . In this paper we summarize connection between education of Mathematics in past with present.

Key Words: Past Mathematics Education, present Mathematics Education

Introduction:

In ancient time ,India had education system which was Gurukula, in this system any student form anywhere, if he want to learnt, or eager to take education, went to Guru's house or we called Ashram for taking further education, he stay at their place for completing education. The ancient education system was known as source of knowledge. In India if we travel across the India we found that different region have different language and different climate also different weather, variation is found across India. The India culture, religion, atmosphere etc. are part of ancient education system.

In ancient period Elementary Mathematics is part of Mathematic education. The formal education is only available to male child with having high staus.The main objective of Mathematics Education was to give basic skill of numeracy.

For development of India most of investment was done in child education, each every child must get education. Since government keep in mind that the people of science and mathematics play very important role in nations economy. The main objective of mathematics education in to research in mathematics education

Methodology:

The major contribution for development of mathematics in ancient was given by Bhaskara II Aryabhata, Brahmagupta, , and Varāhamihira, Nowadays teacher teaches mathematics but they are not given historical touch to present teaching , therefore students don't know about connection between

past and present education. Now a days there is question is raised is it mathematics education is adding up to ancient? There are many reasons i)Lack of Application: One of the major reasons most of the concepts are not clear by teachers, along with application in daily life. Also not making connecting between real life problem with mathematical solution. Also not providing connection between past and present mathematic education.ii)Lack of innovations; Teacher teaches 30-40 min. in class every student is unique , not having equal IQ, they need special attendance, therefore it make gap between them. It was found that While teaching mathematics, history of mathematics plays a very important role to develop affective domain of learners.therefore it is very important to give historical evidence while teaching mathematics in Classroom.Brhamgupta was first used the variable after that Aryabhata I

Result :

Today we use decimal number system it was invented by Indian mathematician. Also Indian mathematician have contribution to concept of zero , negative number, algebra, arithmetic , trigonometric etc. Further it make advance in India such as sine and cosine functions concepts was developed, Most of the concept were transfer to middle East, Europe. Ancient and Indian Mathematics all works together in Sanskrit, which consist of section call as sutras. Ancient Indian mathematician make landmark in developing series expansion for trigonometric functions such as sine , cosine, arc tangent etc.Arybhata I described the most important concept in Sanskrit shlokas , such as Quadratic equation, trigonometry, value of Pi upto 4 decimal places, introduction to trigonometric function sine, cosine value, gives methods of calculating different values of numeric, Arithmetic , Algebra-solution to quadratic equations, general solution to indeterminate linear equation, Mathematical astronomy, spherical trigonometry etc. . Varahamihira given Pancha siddanata .Brahmagupta theorem on rational triangles, Brahmagupta formulas, Brahmagupta identity, Mahavira written book in which he discussed topic Zero, square, cubes, square root , cube root, Plane geometry, square geometry, Formulae of area of an ellipse and quadrilateral inside circle , also he solved quartic , cubic equations, general solution to higher order polynomial equations, solve indeterminate quadratic, cubic equations.

Conclusion:

In classroom the Discussion of some concept how it originate from past is helpful for acquiring knowledge .Ancient Mathematics is foundation or basic to develop present mathematics education all over world . since from ancient as time passes there was progress was seen in research upto date. Therefore there is not only connection between past and present mathematics education in India. It is totally depend on past mathematics education.

47. Special Function and Its Multidisciplinary Application

Special Function and their Multidisciplinary Applications

Sonawane R.D.

Department of Mathematics

New Art's Commerce and Science College, Parner Dist. -Ahmednagar

Email id-rdsmaths9@gmail.com

Special functions are the Mathematical functions , Special Functions has wide range applications in Science , Technology, Engineering. In this paper we summarize applications of Special Functions in some disciplines.

An Application Of q -Hypergeometric Series

Poonam Sharma, Harshita Bhardwaj

Department of Mathematics and Astronomy,

University of Lucknow, Lucknow 226007 India

Emails: sharma.poonam@lkouniv.ac.in, connectharshita@gmail.com

In this paper, we define a class $S_q^{\gamma,\alpha}([\alpha_1], A, B)$ of analytic function $f \in A$ with the help of a q -analogue of Dziok-Srivastava operator. A sufficient coefficient condition for an analytic function f to be in class $S_q^{\gamma,\alpha}([\alpha_1], A, B)$ is obtained. Also it is proved that this coefficient condition is necessary for the function in its subclass $TS_q^{\gamma,\alpha}([\alpha_1], A, B)$. Further, convexity and radius results are obtained for the subclass $TS_q^{\gamma,\alpha}([\alpha_1], A, B)$.

48. Importance of Technology in Mathematics Teaching

INDIAN SCIENCE TECHNO FESTIVAL ISTF-2021 (VIRTUAL)

26-28TH FEBRUARY 2021

Paper Presentation for Teachers

(Open to all School Teachers & Colleges Faculty)

SCIENCE & TECHNOLOGY FOR INNOVATION & SUSTAINABLE INDIA

Importance of Technology in Mathematic Teaching

RANI DADABHAU SONAWANE

ASST. PROF.

NEW ART'S COMMERCE & SCIENCE COLLEGE PARNER, DIST.-AHMEDNAGAR

MOBILE NO. 8805177492

rdsmaths9@gmail.com

(27/01/2021)

Abstract:

The aim of this paper is to summarize information about Importance of Technology in Mathematics Teaching.

Key Words:

Various Technologies in Mathematics Education etc.

Introduction:

In Present day in Mathematics teaching process, Teachers, Professors mostly used in chalk and board method, because by using this method , Teacher and Students are most comfortable , they can interact with each other and with help of board they get easily understand the concept by writing on the board. Now days it is necessary to everyone Student as well as Teachers have knowledge of Technologies which make advance Mathematical skill like Reasoning, problem solving etc. if Mathematics Teacher use Technology while teaching then he/ she can provide greater access to Mathematics for all student for effective teaching mostly Teachers uses Technology.

Methodology:

Mathematics is very important subject, since from Ancient up to date all human using Mathematics, for Counting, Measuring, Weighting etc. Mathematics is also very important in other subject also, without Mathematics no subject is complete. Mathematics is queen of all sciences. In area such as Mathematics Research, Mathematics Education, Mathematics application has changed or we can say developed a lot in the last years. Most of the changes are in computer application such Algorithm and Programming, Modelling, Conjecturing, lecturing etc. Now days there is major impact of new trends on Mathematics education .

Trends of Technology in Mathematics in 20th century:

In early era application of Mathematics was very limited as , time passes there tremendous development was seen in Mathematics. In 20 century Mathematics is used pure as well as Applied Mathematics, due to lack of technology there is limitation to see the functions graphically, or most time student were not understand the Mathematics concept in clear manner, Pure Mathematics is very hard for student to understand. Application of Mathematics is limited. Mathematics is very important in other subject, but there were many limitation to understand the concept Non-Mathematics person while he/she doing research in Non- Mathematics subject.

Interdisciplinary Approach of Mathematics in Technology:

Now days Interdisciplinary approach in Mathematics is very important , it is useful .due to covid situation our Education System is going speedily towards paperless, advanced technology. Using technology it is difficult task for teacher as well as student also. Since internet connectivity problem, electricity problem such type of problem mostly faced student from rural area. In Mathematics teaching Technology play important role since most of the concept in Mathematics are imaginary we can understand it properly but by using graphical in Computer we can understand 3D dimension concept, figures very well, hence technology is useful, but it has some drawback also due to indirect contact with student it is difficult explain all formula, equation to student, since all student doesn't have same IQ .According to that Teacher teaches them but using technology we can't understand each student mentally. This major drawback of this technology, some student are from rural area , some from background of poor family in such case they can afford mobile , therefore education is not reach to everyone therefore education is difficult to such type of student. In that case technology is worthless.

Result :**Emerging Mathematics Interdisciplinary Application Areas using Technology:**

Mathematics has many more application in different areas such as

1) For network security, mobile communication, sensors etc.

Mathematics used in network security, mobile communication, sensors using binary coding system various research were done therefore by using Mathematics various technology were developed , still in progress. Now days security key is very Important ,in case of password of bank account, military area , online marketing, in private as well as government sector security is very important in case of password, by using coding theory , research can develop code for it.

2)For software purpose which are used in Computer Language, Technology etc.

In Computer language technology is vastly spread , since using Mathematics in programming critical problem solved easily, which is useful to everyone, but most of the people do not know where Mathematics is used, without Mathematics it is impossible.

3)Used in logical thinking , decision making.

Mathematics is the subject of decision making , thinking power ability increased , people can develop their logical thinking which is widely used in technology, mostly Mathematician have more such ability since subject provide such knowledge in greater extent. The fore new innovations are occurred.

4) Used in Technology field such as Biotechnology, Biochemistry etc.

In pure Botany subject Mathematics use is less , but in case of Biotechnology , biochemistry Mathematics is used , without Mathematics subject is incomplete, this is best example of Technology, advance subject of Botany and Chemistry in which Mathematics widely used.

5) Spectral Analysis, stochastic analysis etc.

In this Mathematic is used mostly spectral analysis , Stochastic analysis is bigger research topic where Mathematics is used.

6)Satellites, wireless communication system, Robotics , lighter vehicles etc.

In Space science also Mathematics used to develop, construct, launch , divide time , weight , which part is better , how to fit it into satellite, for all this Mathematics is very important, using Mathematic one can easily calculate it.also using digital binary system wireless communication is also done, in robot and lighter vehicles technology Mathematics is used since all calculations are done with help of Mathematics, programming is very important

since programme are inserted in it. For making programme Mathematics is very important, now advance technology is making a lighter vehicles it bigger task for engineers to make lighter vehicle for this using different programme, weight they can do .

7) Mathematics used in Construction technology (e.g. Pythagorean theorem, sampling methods, volume of cylinders, Trigonometry etc.)

In Civil Engineer uses Mathematics since using it they can develop plan of construction, in minimum space that can created large building plan which are very successful, using pythagoraeam method they can calculate area, slope , it is widely used in construction, most tower in world , were created by engineer by using Mathematics concept. For advance technology Mathematics is very important.

8) Mathematics has application in Carpentry (Angular Measurement, calculation with decimal and fractions, Angular Measurement conversions etc.)

In Carpentry minute measure are there which are done only with help of Mathematics, by taking exact measure it is helpful in carpentry.

9) Mathematics very essential in Site Layout(unit conversion for length , volumes, length, interpreting drawings etc.)

In each every Measurement such as length, volumes, area, drawing, in all such case using Mathematics it can be done very easily.

10) It is used in Project supervision is it is used in form of Network diagrams, Bar, Graphs etc.

In Graph, Mathematics is used , in fact Graph Theory is the subject of Mathematic, in Computer Science Mathematics is used , in programming it is used, therefore Mathematics widely used.

11) Waste data which are scattered in distributed manner , Mathematics arranged in systematically.

Large number of data is distributed , so using Combination, Permutation we can arrange such date in systematically manner, we can select any particular object form large number data using Mathematics formulae , Mathematics is key of technology.

Conclusion:

Technology provides more information to Student, Teacher, kids ,everyone who need it, it provide innovative approaches, using Technology peoples are very satisfied since using various Technology work become easily done , effort reduces , therefore technology is very useful to each and everyone, imaginary concept in Mathematics become visible in this digital

world , curiosity of Student increase more . MATHEMATIC IS KEY OF TECHNOLOGY.
In Technology Mathematics is widely used Mathematics is very important without
Mathematics it is difficult task for **Everyone**.

49. Strategy of e-marketing Library information**STRATEGIES OF E-MARKETING IN LIBRARY INFORMATION PRODUCTS AND SERVICES**

Dr. Bhausaheb Bhimaji Shelke,
Librarian,

New Arts Commerce and Science College,

Parner Tal- Parner Dist- Ahmednagar,

bhausaheblshelke@gmail.com, Mobile: 9421331827

Abstract:

This paper is a research library supporting learning activities. Mainly deals with the advent of Internet and e-services as well as the future challenges that e-services provide. In addition the consequences of e-services adoption at library organization, its business model as well as relationships with customers, publishers and other research libraries have been investigated. The main results can be summarized as follows, Adoption of e-services at a very fast. Innovation is driven, among other factors, by ICT development. E-services have changed the organizational structure and the division of labour within the library. 3) E-services have changed the relationships with users and publishers. 4) E-services have changed the business model of the library. 5) Library is becoming a combination of a virtual and physical library, moving more and more towards a virtual library, but still keeping the traditional function of a "knowledge space".

Key Words : Library, Library Management, E-Service, E-Marketing, Internet, India.

INTRODUCTION

The society, wherein information and knowledge evolves, becomes a great society. Marketing of information is a new idea which plays a major role in libraries and information centers. Marketing is a social and managerial process which occurs by transaction or exchange of one another's needs through individuals or groups.

According to Levitt, "Marketing is concerned with satisfying the needs of the customers by means of product and the whole cluster of things associated with creating, delivering and finally consuming it". It has been accepted by the library and information centers those information products and services are an identical part of management. It especially can be helpful in enhancing user's satisfaction and in providing encouragement to customers in the use of current future services. In the profession of library, three factors influence the marketing of information products and services – they are: information explosion, revolution of technology, and the broad scope of library. From these factors it can be said that in this competitive age of information, marketing is a tool which gives a new life.

E-MARKETING

The word "e" is related as a medium of modern technology of "Internet". So, it can be said that e-Marketing is Internet Marketing. e-Marketing has an extensive scope in which

Research Methodology in Library Science, Social Sciences and Commerce / 679

information occurs by use of internet, email, and other such tools. And it also helps in maintaining relationship with the users.

In order to encourage information services, the tradition of age-old optimism of printing a bunch of bulletin or notes and keeping it on a table with the hope that some one will come and read has eloped. Today users hope to get information of his/her choice at right time and at right place. With the help of e-Marketing the internet provides vast possibilities of user contacts by coming out such limitations. e-Marketing keeps the user in continuous contact with library products and services and makes him/her more active. User who is not visiting library daily, for them e-Marketing is a effective tool for getting attractive, rapid and inexpensive information.

ADVANTAGES OF E-MARKETING

- Exchange of library information by global area.
- Round the clock (24 x 7) availability of library services/information, at anywhere.
- More users at a time can make use of library.
- Better information services can be provided with less manpower.
- User's time and expenses are reduced.
- More and easy conformity can be attained with future changes.

STRATEGIES OF E-MARKETING IN LIBRARY INFORMATION PRODUCTS & SERVICES

Internet is an advanced form of modern technology which removes the limitations of remoteness through modern technology tools and becomes helpful in timely e-Marketing of library products and services to the users.

It can be done as shown below.

Library website (homepage)

Library website is a modern link between a library and users. The homepage of a website should reflect the library services. The homepage should be so attractive that users can easily find and acquire library services and information with a single click.

Library membership registration

Online forms for library members should be uploaded in the website of library. So, that the users can fill up the online form and get easily avail the library services.

Online library visit (Library orientation)

Online library visit helps in saving the time of staff and provides the library products and services to the users. Large libraries where the number of users is more, the online library visit is a tool which provides rapid identification to the library.

Online user education course

Hybrid library has changed the definition of traditional library. Now days the exchange of information occurs through OPAC, in-house databases, online databases and internet. Dues to these broad and technological alternatives, there had been increased in the number of users. It has become necessary to impart online education to the users for precise and quick access of information from a certain databases so that the users can find necessary information.

Emails v FTP

Email enjoys a leading position in communication and information media. Besides, it is less expensive than the other media. The user can access the information about necessary book/items, and also renew and reserve it with the help of email. Also the exchange of information in large promotion can be done through the FTP.

Forum or discussion group

Today many forums and discussion groups of various subject fields are available on internet. User can become a member of such forums or groups and can get knowledge about any problem or subject in his/her field and about new researches. To avail of this service a library should prepare a list according to the subjects of the users. Also, for the facility of instant messaging, chat rooms or video conference should be made available in a library.

Blog

New research in the user's subject field and other related data can be collected and classified and shown in the "Blog", so that every user can easily get information from the library blog.

Book talks or other lectures

Book talk's digital recording, special lectures from subject experts and other multimedia presentations without copyright can be uploaded and delivered to the users.

e-Query service

e-Query service is a web reference service which is given those users who possess the library membership. Here users can ask any question related to library information through email.

Social networking

More users can connect with each others by making a use of social networking in library and can get necessary information with the help of social networking. Facebook, Twitter, MySpace etc are extensively used in the social networking. For sharing the information with the help of social networking, a library page can be made in Facebook; Twitter's 'additional feature' can be used to making a group and share the information.

An Institution's events/meeting diary

Online diary of events and meetings of an institution can be prepared and uploaded in library's homepage, so that user can easily get information about an institutions events/meeting by visiting library's website.

DR. RANGANATHAN'S CONCEPT OF THE FIVE LAWS OF LIBRARY SCIENCE HAVE THE

E-MARKETING CONCEPT AT ITS CORE.

The Five Laws were:

- 1) "Books are for use." (Maximize the use of information/e-Information or resources.)
- 2) "Every reader his/her book." (User is the prime factor and his/her need must be satisfied.)
- 3) "Every book its reader." (Find a user for every information/e-Information or resources.)
- 4) "Save the time of the reader." (Organize information/e-Information in such a way that the user

finds the information wanted promptly.)

5) "A library is a growing organism." (Emphasis is on comprehensive and evolutionary growth.) Focusing on customer/user needs (second law) and wants through saving of time (fourth law) is understandably emphasized in these laws. Also, the third law activity to finding a reader, probably implying that the library should reach out to the customers/users. A reliever investigation needs various types of modifications. Still, firstly the definition of a consumer/user only as a reverend needs to be widened to allow the role of representation and distance of using the information. Secondly, in today's circumstance the use of computers/IT to process the information/e-Information obtained from library may give increase to totally new needs and wants. Thirdly, presumption the utility of information in one library to customers/users in different and far off locations, reaching out to customers/users is becoming far more important. Thus, though customer/user focus has long been advocated in library profession, it may be refined to suit the current context of the e-Marketing.

LIBRARY PRODUCTS AND SERVICES, E-MARKETING AND THE USERS

The relationship between library products and services, e-Marketing and the users on the basis of the five laws of e-Marketing is shown in figure-1. Accordingly the e-Marketing of library products and services reaches to the users and it also provides information about proper quality as required by the users.

CONCLUSION



Marketing is a human directed activity in which need or demands is caters through the process of exchange, same in the case of a library. In today's digital age it is essential to do digital marketing of the products and services of an informative library. In order to improve the quality of a library and provide satisfactory and timely information to the users the sources of information should be used by every library. A library should make use of modern tools of e-Marketing to provide e-Information to its users. In today's competitive and technological age e-Marketing should be made inevitable to provide library products and services to the users.

Reference :

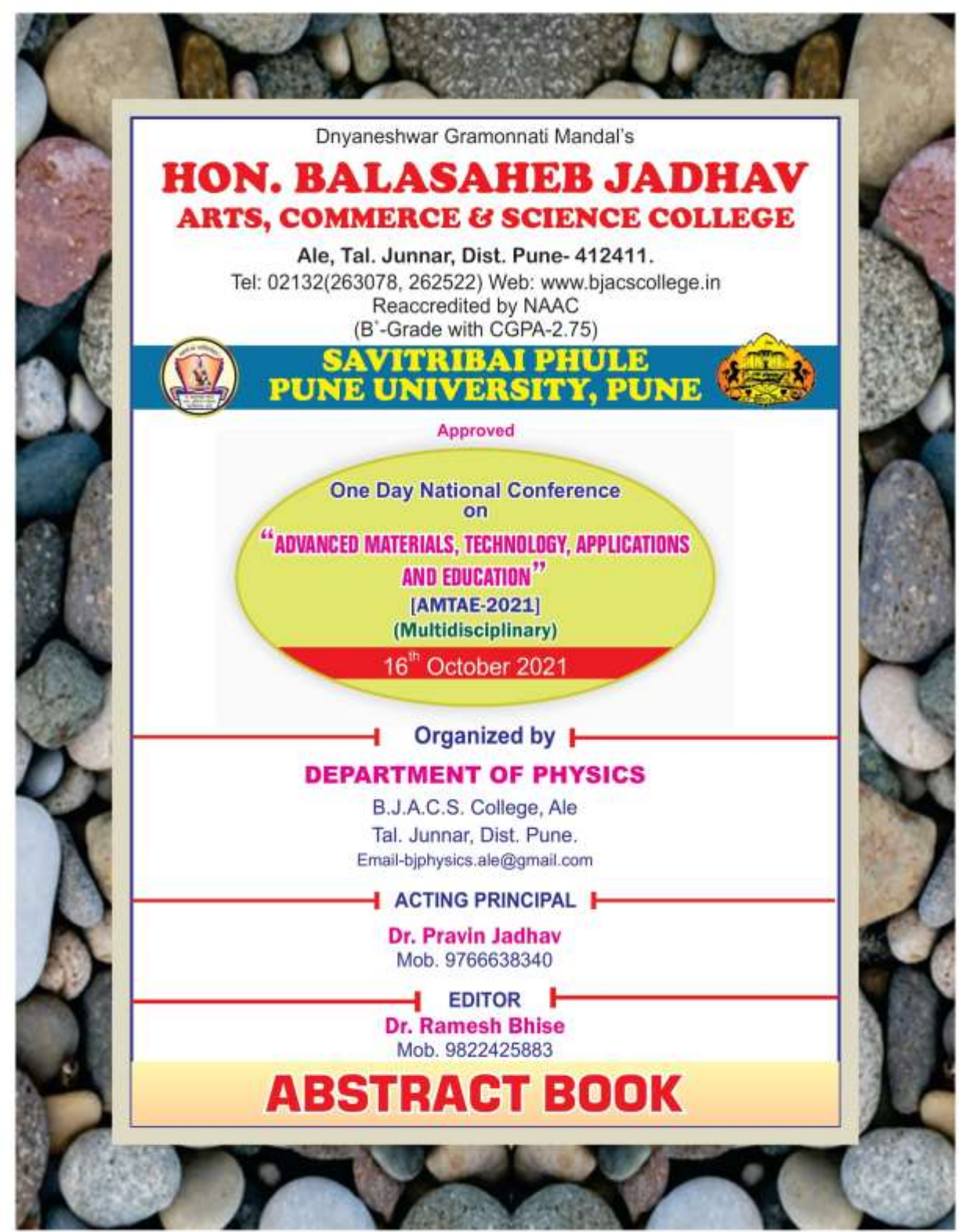
1. Scupola, Ada, "Adoption of E-Services in Libraries: Danish Experiences and Challenges" (2007). *MCIS 2007 Proceedings*. Paper 1. <http://aisel.aisnet.org/mcis2007/1>
2. Dataveillance: Employee Monitoring & Information Privacy Concerns in the Workplace
3. www.irma-international.org/article/dataveillance-employee-monitoring-information-privacy/72709/
4. User Experiences of the E-Commerce Site with Standard User Interface
5. www.irma-international.org/chapter/user-experiences-commerce-site-standard/14725/
6. Implementing Virtual Career Counseling and Advising at a Major University
7. www.irma-international.org/article/implementing-virtual-career-counseling-advising/4118/
8. Successful HIT Requires Inter-Team Communication
9. www.irma-international.org/article/successful-hit-requires-inter-team-communication/102714/

50. Ferrite and Ferroelectric Properties of (y) BaTiO₃ + (1-y) Ni_{0.90}Co_{0.05}Cu_{0.05}Fe₂O₄ Composites

Dnyaneshwar Gramonnati Mandal's
**HON. BALASAHEB JADHAV
ARTS, COMMERCE & SCIENCE COLLEGE**
Ale, Tal. Junnar, Dist. Pune- 412411.
Tel: 02132(263078, 262522) Web: www.bjacscollge.in
Reaccredited by NAAC
(B⁺-Grade with CGPA-2.75)

 **SAVITRIBAI PHULE
PUNE UNIVERSITY, PUNE** 

Approved

One Day National Conference
on
“**ADVANCED MATERIALS, TECHNOLOGY, APPLICATIONS
AND EDUCATION**”
[AMTAE-2021]
(Multidisciplinary)
16th October 2021

Organized by
DEPARTMENT OF PHYSICS
B.J.A.C.S. College, Ale
Tal. Junnar, Dist. Pune.
Email-bjphysics.ale@gmail.com

ACTING PRINCIPAL
Dr. Pravin Jadhav
Mob. 9766638340

EDITOR
Dr. Ramesh Bhise
Mob. 9822425883

ABSTRACT BOOK

OP-45

Ferrite and Ferroelectric Properties of (y) BaTiO₃ + (1-y) Ni_{0.80}Co_{0.05}Cu_{0.05}Fe₂O₄ CompositesS. L. Kadam^{*1}, R. B. Kharade², R. B. Bhise³, S. S. Satpute⁴

1,2- PG Department of Physics, New Arts, Commerce and Science College, Parner, Dist. Ahmednagar, Maharashtra – 414 302

3- PG Department of Physics, Hon. Balasaheb Jadhav Arts, Commerce and Science College, Ale, TalJunnar, Dist. Pune, Maharashtra - 412 411

4- PG Student, PG Department of Physics, New Arts, Commerce and Science College, Parner, Dist. Ahmednagar, Maharashtra – 414 302

*Corresponding Author Email: mr.sukadeo@rediffmail.com M. No. 9423463540

Abstract: A group of elastically coupled ferrite and ferroelectric composites with the general formula (y) BaTiO₃ + (1-y) Ni_{0.80}Co_{0.05}Cu_{0.05}Fe₂O₄ (where y= 0.80, 0.65 and 0.50) was prepared by ceramic method. The X-ray diffraction pattern of the composite confirms a spinel phase formation for the ferrite and perovskite phase formation for the ferroelectric phase. The average grain size was determined by SEM micrographs. The sintered composites exhibit typical hysteresis loops at room temperature. The resistivity, thermoelectric effect and the dielectric properties was examined. The parameters of the composites vary with the ferroelectric/ferrite content. The temperature dependence of dielectric behavior at a frequency 1 kHz was also studied. With decreasing content of BaTiO₃, the dielectric constant decreases and the Curie temperature increases.

Keywords: Ferrite, ferroelectric, composite, dielectric

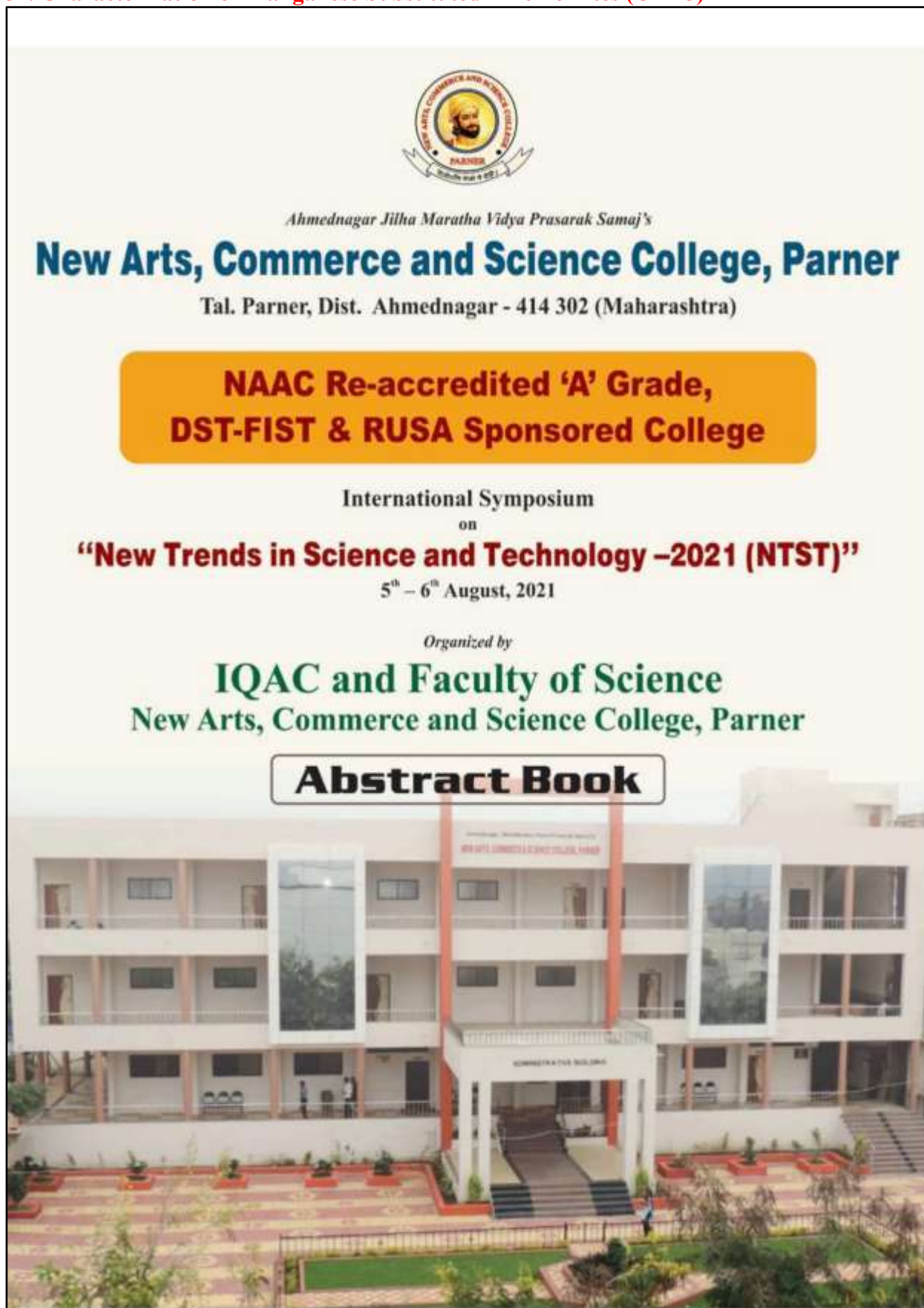
51. Characterization of Manganese Substituted Zinc Ferrites (OP 45)

The image shows the cover of an abstract book. At the top center is the logo of Ahmednagar Jilha Maratha Vidya Prasarak Samaj, featuring a portrait of a man in a circular frame with the text 'NEW ARTS, COMMERCE AND SCIENCE COLLEGE, PARNER' and 'FUND. 1981'. Below the logo, the text reads 'Ahmednagar Jilha Maratha Vidya Prasarak Samaj's' in italics, followed by 'New Arts, Commerce and Science College, Parner' in a large, bold, blue font. Underneath, it says 'Tal. Parner, Dist. Ahmednagar - 414 302 (Maharashtra)'. A prominent orange rounded rectangle contains the text 'NAAC Re-accredited 'A' Grade, DST-FIST & RUSA Sponsored College' in bold black font. Below this, it states 'International Symposium on "New Trends in Science and Technology -2021 (NTST)"' in bold black font, with the dates '5th - 6th August, 2021' underneath. The organizers are listed as 'Organized by IQAC and Faculty of Science, New Arts, Commerce and Science College, Parner'. A white rounded rectangle with a black border contains the text 'Abstract Book' in bold black font. The bottom half of the cover features a photograph of the college building, a multi-story structure with a central entrance and a courtyard with a green lawn.

International Symposium on "New Trends in Science and Technology"
(NTST-2021)

August 5 and 6, 2021

PS-105

Characterization of Manganese Substituted Zinc Ferrites

S. L. Kadam

Post Graduate Department of Physics, New Arts, Commerce and Science College, Parner, Dist. Ahmednagar, MS-414302,
India.

Email_Id: mr.sukadeo@rediffmail.com, Mo.No. 9423463540



Abstract

Ferrites are oxide magnetic materials with iron oxide their main component. The first magnetic material known to man, lodestone or magnetite, also happens to be a ferrite. The chemical formula for lodestone is Fe_3O_4 (i.e. $\text{FeO} \cdot \text{Fe}_2\text{O}_3$), double oxide of iron. Studies on Fe_3O_4 helped the development of other ferrites. Here we will discuss manganese substituted Zinc ferrites. Manganese substituted Zinc ferrites $\text{ZnMnFe}_2\text{O}_4$ were prepared by Sol-gel autocombustion method. Different temperatures were used for sintering the sample in air. X-ray diffraction and scanning electron microscopy were used to study the structural and magnetic properties. X-ray diffraction data reveals that the manganese substituted Zinc ferrites are cubic at temperature 973K and tetragonal at higher sintering temperature. The shape and size of ferrites were obtained from the scanning electron microscopy technique. The magnetic studies indicate that, as the sintering temperature increases the ferrimagnetic behavior also increases. Ferrites show semiconducting properties with their resistivity varying from 5×10^{-10} for Fe_3O_4 to 10^{-10} $\Omega\text{-cm}$ in NiFe_2O_4 . Ferrites have chemical formula MFe_2O_4 or $\text{MO} \cdot \text{Fe}_2\text{O}_3$, where M is a divalent metal ion and Fe is a trivalent metal ion. The technological importance of ferrites can be gauged from the wide spectrum of their applications. The properties of ferrites depend upon the preparation method, preparation conditions, cation distribution and magnetic interactions.

Keywords: Ferrites, X-ray diffraction, scanning electron microscopy, sintering.

52. Pro 51 - Optimization and Decolorization Of Methylene Blue Dye Using Aluminium Oxide Nanoparticles (OP 88)

Dnyaneshwar Gramonnati Mandal's
HON. BALASAHEB JADHAV
ARTS, COMMERCE & SCIENCE COLLEGE
Ale, Tal. Junnar, Dist. Pune- 412411.
Tel: 02132(263078, 262522) Web: www.bjacscollge.in
Reaccredited by NAAC
(B⁺-Grade with CGPA-2.75)

 **SAVITRIBAI PHULE** 
PUNE UNIVERSITY, PUNE

Approved

One Day National Conference
on
“ADVANCED MATERIALS, TECHNOLOGY, APPLICATIONS
AND EDUCATION”
[AMTAE-2021]
(Multidisciplinary)
16th October 2021

Organized by

DEPARTMENT OF PHYSICS
B.J.A.C.S. College, Ale
Tal. Junnar, Dist. Pune.
Email-bjphysics.ale@gmail.com

ACTING PRINCIPAL

Dr. Pravin Jadhav
Mob. 9766638340

EDITOR

Dr. Ramesh Bhise
Mob. 9822425883

ABSTRACT BOOK

OP-88

OPTIMIZATION AND DECOLORIZATION OF METHYLENE BLUE DYE USING ALUMINIUM OXIDE NANOPARTICLES*V. P. Dhawale¹, S. K. Aher² and S. D. Kulkarni³*¹PG Department of Physics, New Arts Commerce and Science College, Parner, Ahmednagar,²PG Department of Botany, New Arts Commerce and Science College, Parner, Ahmednagar,³PG Deptt. of Environmental Science, New Arts Commerce and Science College, Ahmednagar, IndiaEmail address: vijaya.dhawale2009@gmail.com**Abstract**



Aluminium oxide nanoparticles were prepared by sol-gel method using ethanolic solution of $AlCl_3$, 25% NH₃, along with capping agent polyvinyl alcohol (PVA). Synthesized nanopowder was applied for decolourisation of Methylene Blue (MB) dye. Parameters varied were concentration of MB dye, pH of a MB dye and aluminum oxide nanoadsorbent dosages. It was observed that, decolourisation decreases with increase in dye concentration at same pH of dye and same dose of adsorbent. Also it was observed that, at same dye concentration and same pH value, with increase in amount of nanoadsorbent, decolourisation remains approximately constant for smaller dose of 10mg/l dye and decreases for 15 mg/l dye concentrations. By keeping dye concentration of 10 mg/l constant, pH of dye changed from 6 to 8 and nanoadsorbent dose were varied 50, 100 and 150 mg, it was observed that, at 100 mg nanoadsorbent dose and at pH 7 of dye, decolourisation obtained maximum. Therefore optimized dye concentration was 10 mg, at the 7.0 pH of dye and 100 mg dose of nanoadsorbent. The characterization of synthesized nanoparticles were carried out by using UV-Visible spectroscopy, XRD, FTIR, SEM, EDAX, DTA and TGA, Raman spectroscopy and TEM. From UV-visible spectra, band gap obtained was 3.31 eV. Average crystal size of $\alpha-Al_2O_3$ nanoparticles from XRD peaks found to be 25 nm having rhombohedral structure. FTIR spectra revealed that functional groups (O-Al-O) were present which confirms aluminum oxide nanoparticles. SEM image shows surface morphology of $\alpha-Al_2O_3$ nanoparticles. Chemical composition of $\alpha-Al_2O_3$ nanoparticles was confirmed from EDAX spectroscopy. Raman spectra showed crystalline nature of $\alpha-Al_2O_3$ nanoparticles. The %weight loss with temperature of TGA curve shows that nanoparticle formation temperature is 762°C and transition temperature is 800°C 77% weight loss with one step. The DTA curve shows endothermic reaction take place during nanoparticle formation attributed to moisture loss and to hydroxyl loss from the decomposition of hydrated aluminium chloride and aluminium hydroxide. Aluminium oxide nanoparticles were synthesized and applied successfully in waste water treatment as a nano adsorbent.

Keywords: Adsorbent, optimization, decolourisation, methylene blue dye**References**

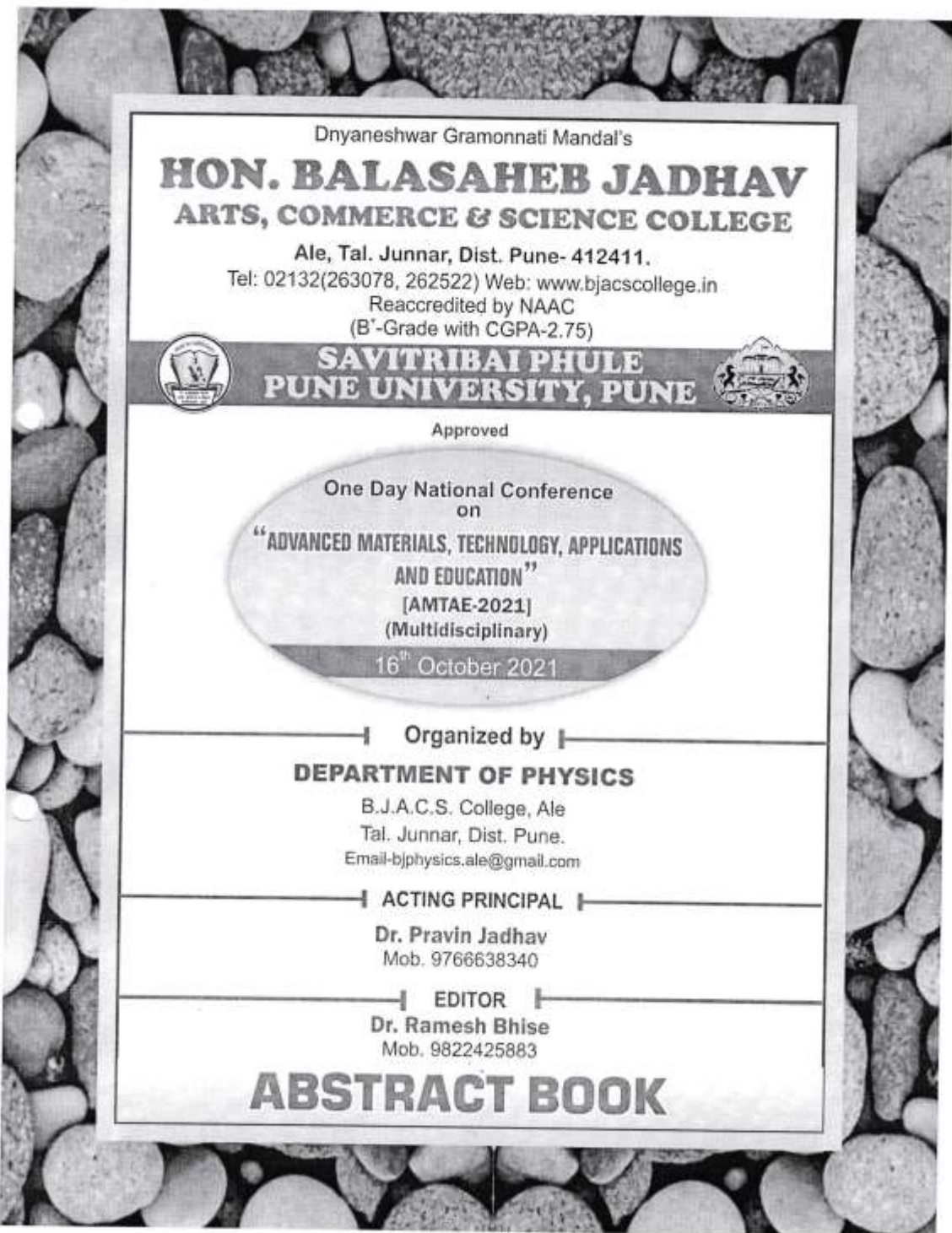
1. Yang, X.; Chen, W.; Huang, J.; Zhou, Y.; Zhu, Y.; Li, C. Rapid Degradation of Methylene Blue in a Novel Heterogeneous Fe₃O₄@rGO/TiO₂-catalyzed photo-Fenton system. *Sci. Rep.* 2015, 5, 10632. DOI: 10.1038/srep10632
2. Onal, E. S.; Yatkin, T.; Ergut, M.; Ozer, A. Green Synthesis of Iron Nanoparticles by Aqueous Extract of *Eriobotrya Japonica* Leaves as a Heterogeneous Fenton-like Catalyst: Degradation of Basic Red 46. *IJCEA* 2017, 8, 5

53. Graphene: The Wonder Nanomaterial (OP 89)

Dnyaneshwar Gramonnati Mandal's
HON. BALASAHEB JADHAV
ARTS, COMMERCE & SCIENCE COLLEGE
Ale, Tal. Junnar, Dist. Pune- 412411.
Tel: 02132(263078, 262522) Web: www.bjacscollge.in
Reaccredited by NAAC
(B'-Grade with CGPA-2.75)

 **SAVITRIBAI PHULE**
PUNE UNIVERSITY, PUNE 

Approved

One Day National Conference
on
"ADVANCED MATERIALS, TECHNOLOGY, APPLICATIONS
AND EDUCATION"
[AMTAE-2021]
(Multidisciplinary)
16th October 2021

Organized by

DEPARTMENT OF PHYSICS
B.J.A.C.S. College, Ale
Tal. Junnar, Dist. Pune.
Email-bjphysics.ale@gmail.com

ACTING PRINCIPAL

Dr. Pravin Jadhav
Mob. 9766638340

EDITOR

Dr. Ramesh Bhise
Mob. 9822425883

ABSTRACT BOOK

OP-89

Graphene: The Wonder Nanomaterial**Shinde S. J. and Dhawale V. P.**Post Graduate Department of Physics, New Arts, Commerce and Science College, Parner,
Ahmednagar, IndiaEmail address: swarashinde75@gmail.com**Abstract**

Nanomaterials are the most promising materials for modern development of science and technology. This is the decade which experiences the development of 'future materials'. Graphene is the amazing 2D material, hexagonally packed allotrope of carbon which has attracted great attention by scientific and engineering communities.

Present review article deals an overview of the advancement of research in graphene, in the area of major synthesis methods and properties. It has large specific surface area of $2630 \text{ m}^2/\text{g}$ with sheets having self-repairing capability, impressive intrinsic mechanical properties with highest Young's modulus of $\sim 1 \text{ TPa}$ (Steel- 0.2 TPa). It is tough than steel yet lighter than feather, four times harder than diamond yet elastic than rubber, excellent flexibility which can be maintained even after 1000 times of direct bending, spring constant between $1\text{-}5 \text{ N/m}$ (Gold- 0.9 N/m). Graphene have 98% visual transmission rate, zero bandgap semiconductor with highest electron mobility of $1.5 \times 10^4 \text{ cm}^2/\text{Vs}$ (>100 times than silicon), resistivity is $1 \times 10^{-6} \text{ ohm/m}$ ($\sim 35\%$ less than copper) and charge concentration 10^{11} cm^{-3} at room temperature and thermal conductivity is $2000\text{-}4000 \text{ W/mK}$ (diamond- 2200 W/mK). It has applications electronics, ultra capacitors with better performance than batteries and capacitors, in biomedical engineering for drug and gene delivery. In area of safety application, antibacterial graphene face masks give 100% efficiency to sunlight exposure, in ultrafiltration, in solar panels. Also works on all wavelengths of light and no heat loss like conventional silicon based solar cells. It is used in aerospace sector to create lighter and impact resistance aircraft, to make aircrafts invisible and prevent them from the impact of lightning strike and accumulation of ice in wings. This review article also includes advantages and disadvantages of graphene in day today life.

Keywords: Carbon allotrope, Graphene, Synthesis, Nanomaterial,

References

1. Richa Srivastava (2012); Synthesis and Characterization Techniques of Nanomaterials, International Journal of Green Nanotechnology, 4(1): 17-27
2. Tiwari S.K., Sahoo S., Wang N. and Huezko A. (2020); Graphene research and their outputs;
3. Status and prospect. Journal of Science: Advanced Materials and Device. 5(1): 10-29.
4. Jesus De La Fuente: The applications of, and uses of graphene,
5. Woubong Choi, IndraniLahiri, RaghunandanSeelaboyina and Yong Soo Kang (2010) Synthesis of Graphene and Its Applications: A Review, Critical Reviews in Solid State and Materials Sciences, 35(1): 52-71

54. Effects of spent wash on the physico-chemical properties of soil and early seedling growth in fenugreek (*Trigonella foenum graecum*)

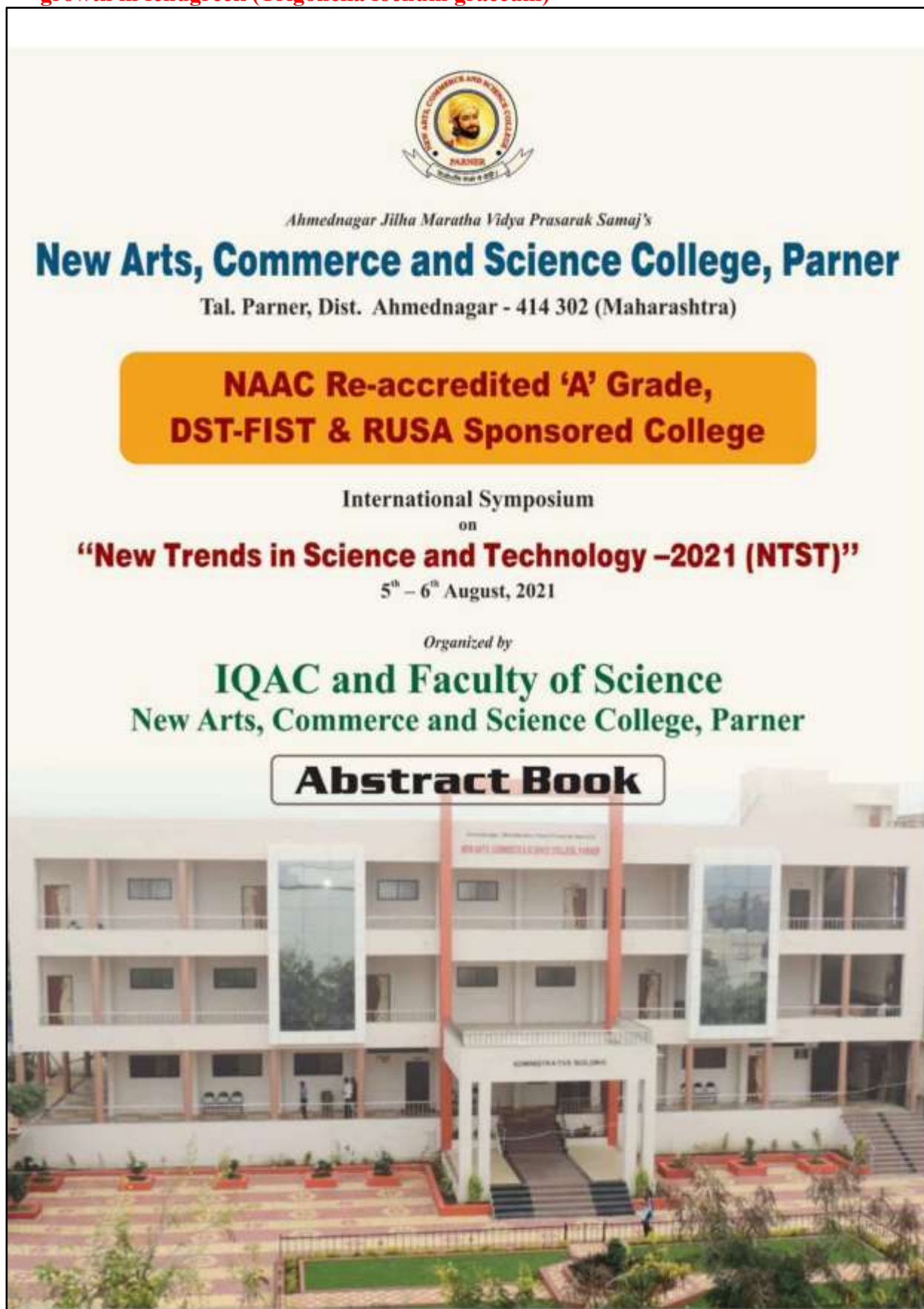

PS-107

Effects of spent wash on the physico-chemical properties of soil and early seedling growth in fenugreek (*Trigonella foenum graecum*)**Kulkarni S.D., Dhawale V.P. and Aher S.K., Zadage J. Shrikant***

1&4. New Arts Commerce and Science College Ahmednagar (MS) - 414 001

2&3. New Arts Commerce and Science College Parner, Dist. Ahmednagar (MS) - 414 302

Corresponding author: Email_Id- vijaya.dhawale2009@gmail.com.

Mob. No. +91 9822725739



Abstract

Distillery spent wash is an effective organic liquid manure derived from distillery industries. A laboratory work was undertaken to assess the effect of various concentrations viz., 2%, 5%, 7%, 10% and 15% on physical and chemical properties of soil, seed germination and root and shoot length of fenugreek (*Trigonella foenum graecum*). The high value of pH, EC, organic carbon, nitrogen, phosphorus, potassium indicated the high inorganic and organic load. Fenugreek grown in soil pot culture conditions with different rates of spent wash showed improvement in germination %, root length and shoot length over control (2%, 5% and 7%). Whereas, higher doses of spent wash (10% and 15%) decreased these parameters markedly. Findings indicated stimulatory effect of lower doses of spent wash (2%, 5% and 7%) on germination %, root and shoot length and inhibitory effect of higher doses (10% and 15%). Therefore, judicious application of spent wash will improve germination %, root length and shoot length and alleviate environmental pollution problems.

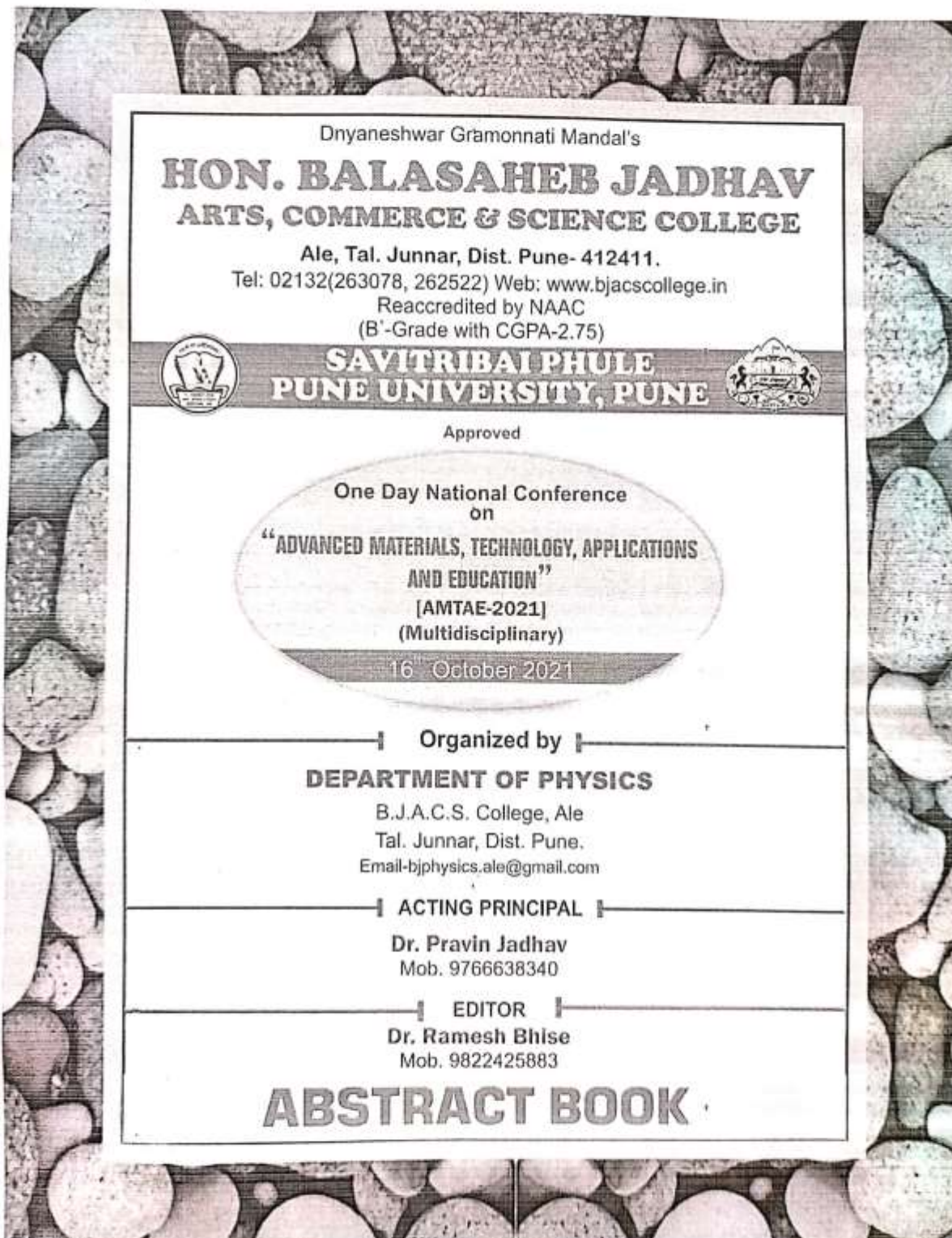
Keywords: Spent wash, soil fertility, germination percentage, seedling growth, fenugreek.

55. Mechano-Chemical Method for Synthesis of Zinc Oxide Nanoparticles

Dnyaneshwar Gramonnati Mandal's
HON. BALASAHEB JADHAV
ARTS, COMMERCE & SCIENCE COLLEGE
Ale, Tal. Junnar, Dist. Pune- 412411.
Tel: 02132(263078, 262522) Web: www.bjacscollege.in
Reaccredited by NAAC
(B'-Grade with CGPA-2.75)

 **SAVITRIBAI PHULE**
PUNE UNIVERSITY, PUNE 

Approved

One Day National Conference
on
"ADVANCED MATERIALS, TECHNOLOGY, APPLICATIONS
AND EDUCATION"
[AMTAE-2021]
(Multidisciplinary)
16th October 2021

Organized by

DEPARTMENT OF PHYSICS
B.J.A.C.S. College, Ale
Tal. Junnar, Dist. Pune.
Email-bjphysics.ale@gmail.com

ACTING PRINCIPAL

Dr. Pravin Jadhav
Mob. 9766638340

EDITOR

Dr. Ramesh Bhise
Mob. 9822425883

ABSTRACT BOOK

OP-114

MECHANO-CHEMICAL METHOD FOR SYNTHESIS OF ZINC OXIDE NANOPARTICLES**R. B. Kharade and Sayyad Jainab**PG Department of Physics and Research Centre, New Arts, Commerce and Science College,
Partner, Ahmednagar, (M.S.) 414302 India.EMail : rmeshkharade@gmail.com**Abstract**

Zinc oxide nanoparticles (ZnO) were successfully synthesized by Mechano-chemical method. Zinc acetate and Tartaric acid were used for synthesis of ZnO nanopowder. Calcinations are take place at 45 °C temperature. The samples were characterized by X-ray diffraction (XRD), scanning electron microscopy (SEM), UV-visible spectroscopy and Energy dispersive X-ray spectroscopy (EDX). A result shows that the calcinations temperature significantly affected the crystalline nature, particle size, and optical properties of the processed ZnO nanoparticles. The XRD spectra indicate that the ZnO crystal has a hexagonal quartzite structure. The optical properties of the samples were investigated by measuring the UV-Vis absorption at room temperature. Band gap is 3.3 eV. The percentage of Zinc and Oxygen were determined by EDX. SEM images agreement with the XRD data shows that the average size of the nanoparticles

Keyword: Zinc oxide, Mechano-chemical method, Nanopowder, Characterization, etc.

56. Low-Density Teos-based Silica Aerogels Prepared at Supercritical Drying Using Ethanol as the Preparative Solvent

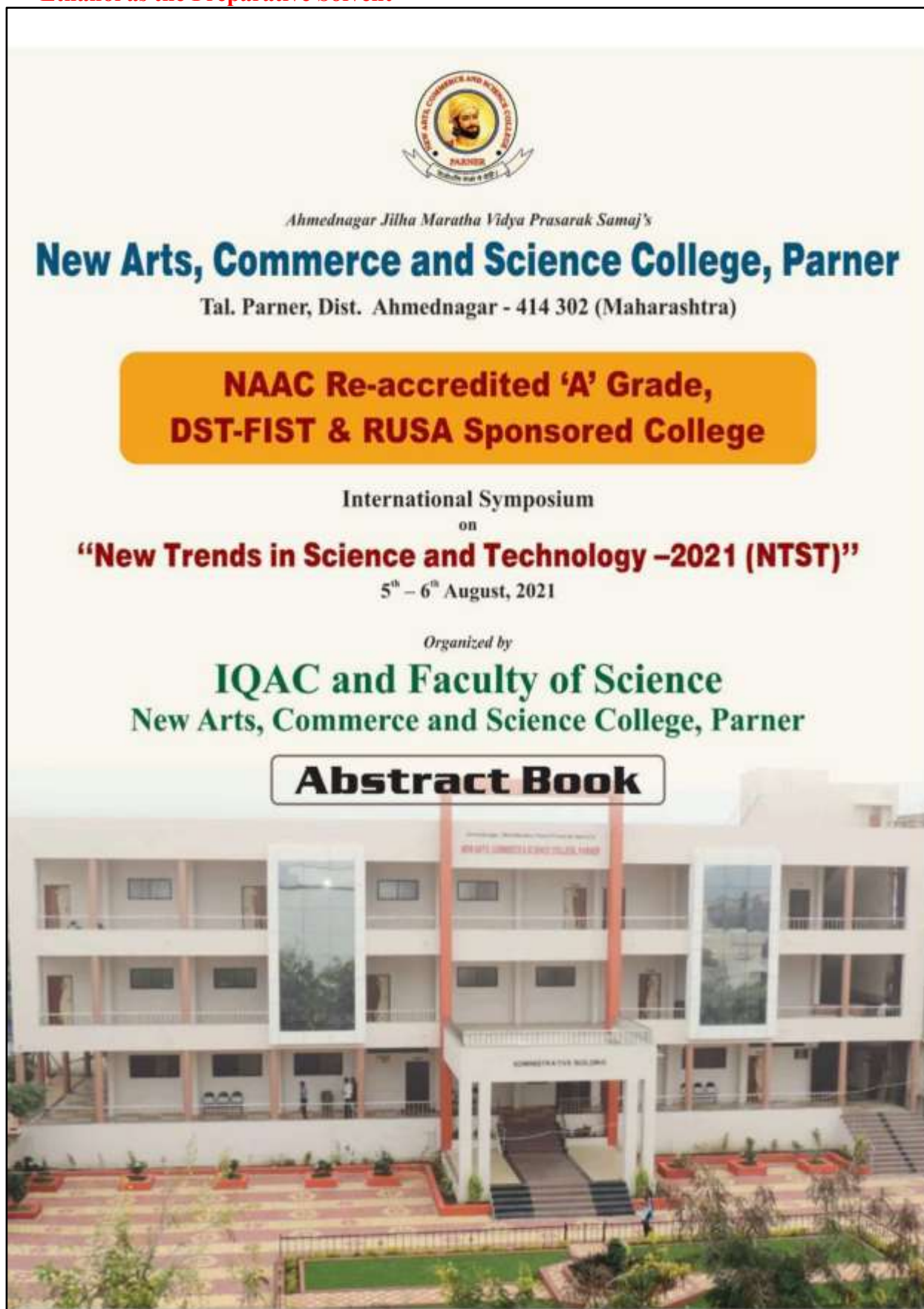

International Symposium on "New Trends in Science and Technology"
(NTST-2021)

August 5 and 6, 2021

Ahmednagar Jilha Maratha Vidya Prasarak Samaj's
New Arts, Commerce and Science College, Parner
 Dist. Ahmednagar - 414 302 (Maharashtra)
 Website : <http://www.newartsparner.com>

NAAC Re-accredited 'A' Grade, DST-FIST & RUSA Sponsored College



International Symposium
 on
"New Trends in Science and Technology –2021 (NTST)"

5th – 6th August, 2021

Organized by

IQAC and Faculty of Science

Convener
Mr. Mahesh S. Aher

Principal
Dr. Ragnath K. Aher

* **Coordinator** *

Dr. Ravindra N. Deshmukh

Mr. Sagar D. Mhaske

Mrs. Rani D. Sonawane

Mr. Nilesh A. Pawar

* **EMINENT SPEAKERS** *



Dr. Pandit Vidyasagar
 Former Vice-Chancellor, SPTU, Mumbai



Dr. Satyajit Rath
 IAS, New Delhi and IISER, Pune



Dr. Arvind M. Deshmukh
 President, Maharashtra Society, India



Dr. Nilesh Patil
 Scientist, IISER, Bhopal



Dr. Surendra Ghaskadbi
 Scientist, AgriStar Research Institute, Pune

Page | 3 | IQAC & Faculty of Science, New Arts Commerce and Science College, Parner-414302,
 Ahmednagar, Maharashtra, India

International Symposium on "New Trends in Science and Technology"
(NTST-2021)

August 5 and 6, 2021

PS-109

**Low-Density TEOS-Based Silica Aerogels Prepared At Supercritical Drying Using
Ethanol As The Preparative Solvent**

Nilesh A Pawar^{1*}, N B Chaure², S M Rathod³

¹ Post Graduate Department of Physics, New Arts, Commerce and Science College, Parner, Maharashtra-414302, India.

² Department of Physics, Savitribai Phule Pune University, Pune-41100, Maharashtra, India.

³ P. G. and Research Department of Physics, Abasaheb Garware College, Pune-30, Maharashtra, India

*Email_Id: nawar9@gmail.com



Abstract:-

Highly transparent silica aerogels based on the tetraethoxysilane (TEOS) precursor were prepared by two-step (acid-base) sol-gel process. The hydrolysis and condensation reactions of TEOS proceeded in ethanol solvent with hydrochloric acid (HCl) and ammonium hydroxide (NH₄OH) as the catalysts, respectively. The wet gels were Supercritically dried using ethanol. The aerogels were characterized by transmission electron microscopy (TEM) and measurements of optical absorption and transmission, bulk density, and porosity. Monolithic silica aerogels with high optical transmission (~85%), low density (~0.062 g/cm³), and minimum volume shrinkage (~10%), were obtained. The aerogels were prepared for different concentration of NH₄OH by keeping the volume ratio of TEOS:EtOH:HCl is 14.92:74.62:10.44 respectively.

Keywords: Silica aerogels, TEM, sol-gel process.

57. Effect Of The Pr (Praseodymium) Substitution On The Structural, Magnetic And Adsorption Properties In Cobalt Ferrite Nanoparticles (OP118)

Dnyaneshwar Gramonnati Mandal's
**HON. BALASAHEB JADHAV
ARTS, COMMERCE & SCIENCE COLLEGE**
Ale, Tal. Junnar, Dist. Pune- 412411.
Tel: 02132(263078, 262522) Web: www.bjacscollge.in
Reaccredited by NAAC
(B⁺-Grade with CGPA-2.75)

 **SAVITRIBAI PHULE
PUNE UNIVERSITY, PUNE** 

Approved

One Day National Conference
on
“**ADVANCED MATERIALS, TECHNOLOGY, APPLICATIONS
AND EDUCATION**”
[AMTAE-2021]
(Multidisciplinary)
16th October 2021

Organized by
DEPARTMENT OF PHYSICS
B.J.A.C.S. College, Ale
Tal. Junnar, Dist. Pune.
Email-bjphysics.ale@gmail.com

ACTING PRINCIPAL
Dr. Pravin Jadhav
Mob. 9766638340

EDITOR
Dr. Ramesh Bhise
Mob. 9822425883

ABSTRACT BOOK

OP-118

EFFECT OF THE PR (PRASEODYMIUM) SUBSTITUTION ON THE STRUCTURAL, MAGNETIC AND ADSORPTION PROPERTIES IN COBALT FERRITE NANOPARTICLES

Nilesh Pawar, S. S. Dhawan, J. S. Karanjule, S. R. Gangarde

Post Graduate Department of Physics, New Arts, Commerce and Science College, Parner, Maharashtra-414302, India.

Email: napawar9@gmail.com**Abstract:**

Rare earth (RE) Pr^{3+} (Praseodymium) Substituted Cobalt ferrite $\text{CoFe}_{1-x}\text{Pr}_x\text{O}_4$ nano particles are synthesised by Sol-gel auto combustion method. The effects of Pr substitution on structural, magnetic and adsorption properties of cobalt ferrite nanoparticles are investigated. Structure, morphology, particle size, chemical composition and magnetic properties of t nanoparticles are studied by X-ray diffraction (XRD), transmission electron microscopy (TEM), high resolution transmission electron microscopy (HRTEM), energy-dispersive spectrometer (EDS), Fourier transform spectroscopy (FTIR), Raman spectra and vibrating sample magnetometry (VSM). The results indicate that the as-synthesized samples have the pure spinel phase, uniform crystallite size and narrow par distribution. Meanwhile, the Pr substitution leads to the decrease in the particle size, magnetization and coercivity of the CoFe_2O_4 ferrite. Notably, it demonstrates that the Pr doping can apparently enhance the adsorption capacity for Congo red (CR) onto ferrite nanoparticles

Keywords: Adsorption; Magnetic nanoparticle; Rare-earth substitution16th October 2021

ज्ञानेश्वर ग्रामोन्नती मंडळ, आळे, संतवाडी, कोळवाडी संचलित

मा. बालासाहेब जाधव कला, वाणिज्य व विज्ञान महाविद्यालय, आळे

ता. जुन्नर, जि. पुणे - ४१२ ४११.

☎ : ०२१३२-२६३०७८, फॅक्स : ०२१३२-२६२५२२

NAAC Grade 'B'

Email : bjcollege_ale@yahoo.co.in

Website : www.dgmale.org



महाविद्यालयाची ठळक वैशिष्ट्ये

- Qualified and Experienced Teacher
- Sports Department (Gymkhana)
- Earn and Learn Scheme
- Remedial Coaching for slow Learners
- Soft skill development programme
- Well Furnished computers Lab with Wi-Fi
- Cultural Activities
- National Service Scheme (NSS)
- National Scholarship (OBC,SC,ST,NT,etc.)
- Book Bank Scheme
- ICT based seminar hall
- Library (Knowledge Resource Center)
- Board of students' Development
- Placement Cell
- Quality Improvement Cell
- Wi-Fi with Broadband and CCTV
- Personality Development programme
- Competitive Examination guidance center
- National Cadet (Girl & Boys) Corps (NCC)
- Well Equipment Science Laboratory
- Add-on and skill Based Course
- Prize distribution ceremony

श्रीकृष्ण प्रेस, आळेफाटा मो.-९९६०४८८६२६

58. Antifungal activity of *vitex nigundo* linn. Against some pathogen of *allium cepa*

Dnyaneshwar Gramonnati Mandal's
HON. BALASAHEB JADHAV
ARTS, COMMERCE & SCIENCE COLLEGE
Ale, Tal. Junnar, Dist. Pune- 412411.
Tel: 02132(263078, 262522) Web: www.bjacscollege.in
Reaccredited by NAAC
(B⁺-Grade with CGPA-2.75)

 **SAVITRIBAI PHULE**
PUNE UNIVERSITY, PUNE 

Approved

One Day National Conference
on
"ADVANCED MATERIALS, TECHNOLOGY, APPLICATIONS
AND EDUCATION"
[AMTAE-2021]
(Multidisciplinary)
16th October 2021

Organized by

DEPARTMENT OF PHYSICS
B.J.A.C.S. College, Ale
Tal. Junnar, Dist. Pune.
Email-bjphysics.ale@gmail.com

ACTING PRINCIPAL

Dr. Pravin Jadhav
Mob. 9766638340

EDITOR

Dr. Ramesh Bhise
Mob. 9822425883

ABSTRACT BOOK

59. The Impact of COVID 19 Pandemic On Mathematics Higher Education**The Impact of Covid 19 Pandemic on Mathematics Higher Education****Asst. Prof. Sonawane R.D.**

New Art's Commerce and Science College, Parner Dist. –Ahmednagar,414302 Maharashtra

rdsmaths9@gmail.com

Abstract :

Covid 19 pandemic has a major impact on the Education System. The Education Policy are changed from Classroom to Home. In this paper we summarize the Effect of Pandemic on online teaching, learning in Mathematics using Survey and Interviews from Teacher as well as from students in Parner Tehsil.

Keywords:

Ancient Education, Mathematics teaching, Mathematics Learning, Covid 19 Pandemic.

Introduction:

In Ancient period, there was Education system of 'Guru Kula'. In Guru Kula Education system, students are living with Guru. The 'Guru Kula' word is combination of the Sanskrit word 'Guru' (teacher) and 'Kula' means family (home). Guru teaches students. .Guru does not take any fees from students . Students gives 'dakshina' at the end of education. In among countries the Indian education system is popular. In Ancient, Medieval periods there was education system in which teachers were trained students for able to survive. After Independence more changes are seen in Education system in all aspects.

Impact of Covid 19 Pandemic on Education:

Nowadays due to Covid 19 Pandemic a lot of changes occurred in Education. All the schools from Nursery to Colleges were closed. Education is going on towards Advanced Technology. There were tremendous changes seen from Ancient Medieval , after Independence up to Covid 19 Pandemic . The whole Education system was changed due to Covid 19 Pandemic .Due to Covid 19 Pandemic all

Schools, Colleges are closed in all countries. This mainly affect on Children's social, environmental growth, Social Skill, Social Awareness.

Impact of Covid 19 Pandemic on Families:

Most of the families are suffered from covid 19 therefore children's life get disturbed. In educated family children easily get electronic gazette, internet facility , therefore online education is affordable for them. The children from rural areas are not easily get electronic gazette, internet, therefore online education is not comfortable for them. It is difficult task for them to get education. Due to Covid 19 pandemic, lockdown domestic violence increase which directly affect on children's mind. Due to covid 19 Pandemic most effect seen on education system. In Poor family , it is very difficult to earn bread and butter for day to day life, they can't afford the expensive treatment of coronavirus , due to not afford treatment ,many family loss their dearest persons.in many family most of the children lost their parents either in the form mother or father, grandfather or grandmother, sister or brother. Therefore the children's mentally get disturb, which effect on their education .most of the children not interested to join school or colleges again, because due to loss of their parents whole responsibilities are on their shoulders. So that most of the children are struggling to get bread and butter, now some of them are away from education schools, colleges, they want to earn money for their family. Financial support for such families is very essential . Mostly seen that in family someone get infected due to covid 19 , or family loss one of the member , then no relative are came back to see them. In such pandemic Corona Virus is spread through sneezing, touching, coughing therefore , not single person go to affected family house. Due to this many children are suffering from this situation. Not single Relative give him shelter. No one taking Responsibility of them.

Method:

In Pandemic, the Education system is moved from classroom to online mode. In Classroom there was interaction between Teacher and Student. There was face to face interaction between Student and Teacher, Students can easily ask their doubts to Teacher, and Teacher can solve their problem by using chalk-board method or personally gives solution on paper, but nowadays the Education is online

mode using Advanced Technology. Students are not familiar with Technology, as time passes students adopt Advanced Technology. Technology is beneficial for Students but there are limitations. The major difference between offline and online Education seen in recent days.

Result and Discussion:

In Covid 19 Pandemic 100% of lectures are conducted online. After a survey we found that online classes are less effective as compared to classroom teaching, when some questions are asked to students about 1. Online Learning 2. About Network 3. About Health 4. About Economic Problem 5. Environment 6. Time Problem etc.

In Open question student given responses, that student from cities are comfortable to new Education system since they can easily available all facilities required for New Education Policy there is no effect seen on the students from cities but mostly impact seen on student from rural areas, they were facing more problems each days, such as internet, electricity problem, lack of mobile gazette, range problems. Most disturbances occurred during learning therefore students from rural areas are not comfortable with new education policies.

In online teaching-Learning, Mathematics student's face more problems in learning since there are more disturbances seen. Due to range, internet problem, electricity problem, cost problem, environment due to this students fail to learn. Also in online Math's class students are not getting each and every aspect of Mathematical equation, Mathematical solution since there are limitations of technology. In offline class, if students fail to understand problems, they can directly ask teachers. Using black-board teacher can solve their problems but in online mode teachers have some limitations.

In Mathematics Teaching -Learning process generally there are Mathematics symbols, Mathematical Equations, therefore it is a very difficult task for teachers to write and it is a time spending process to type notes, give explanations to each equation. The Mathematical concepts are very clear using black-board writing, students' doubts are also clear. In Advanced Technology using some software to write Mathematical equations in online mode, but it is not possible to write equations easily, therefore

it is not possible to write step by step solution of each question. Chalk and Board is the best Method for teaching and learning in Mathematics. There are various online platforms such as Google Meet, Zoom, Flipped Classroom, Google Hangout, WebEx, Video Conferencing ,Microsoft Team, Canvas etc. The educator sent e-content in the form of pdf,Audio, video, word, excel etc. (Pokhrel & Chhetri, 2021)This online education is not affordable for students from economically backward .

Assessment in Mathematics Teaching & Learning:

In Online teaching learning Mathematics, assessment are done online with help of quiz, Google meet Oral. It was found that ,in assessment mostly internet networking problem, weather problems occurred. In assessment , it is difficult task for student to solve the example using tools , it consume time to write solution of example with help of white board or any other software. Importantly, lockdown effects on internal assessment. The online Maths Education depends on ICT , Therefore for educator and learner must know about Information and communication Technology. The assessment of children's are moving towards online with trial and error basis (Burgess & Sievertsen, 2020). In Mathematics mostly for assessment are in the form question or problems and solution form. It is not in the form of objective. Teacher can't assess the students in objective manner. In objective question system , there are MCQ type of True-False system, most of the student are attempt the objective questions and giving fake answers, some of the students got out of marks , so this is not way of proper assessment according to teachers. It is affect on assessment of the students. Mathematics is subject which can teach using chalk –board method. Teachers as well as student are not happy with this online teaching method. Most of the time due to availability of gazette (Mobile or Laptop) student not attain the exam or test, in rural area there is lot of problem of internet range , they are failed attain the exam or test . also due to range problem student are not attending regular lect. Therefore due to continuous network problem , student loss their interest in learning. If anyone lect. is missed by any students they are not understand next day lecture. Day-to-Day student loss their interest in education . most of the student are from poor family having 3 to 4 brother or sister in single family. In such a family, not everyone can afford an electronic gazette for online teaching learning . In such families children are fighting for electronic gadgets. On-line education is difficult for such families. Schools or

colleges do not provide them with such electronic gazettes. Therefore online education is not good for all students.

Challenges in Mathematics Teaching & Learning:

The Economically backward students are not able to afford electronic Gazette, Internet Services. Due to this student academic performance is poor. The technology backward teacher requires training in ICT. Most teachers are not comfortable with new technology, they are not techno savvy, for such teachers require special training, then they can easily take lect. of their respective subject. If teachers fail to get such training, they are not giving proper guidance to students. Therefore all colleges or schools must organise such programs for teachers. Also, students of colleges and schools require training using ICT on how to handle electronic gazettes for attending lectures, for submitting assessment, for attending test, for attending exam, how to make conversation, during lect. how to avoid noise from outside. Such small things are very essential during online lectures. It is the responsibility of Colleges and Schools to organize such training programmes for teachers as well as students.

In Survey it is found that most students from higher education are not comfortable, not getting the Mathematics concept in a clear manner. Therefore advanced technology suffers some drawbacks in some subjects. In Mathematics most of the concepts are imaginary, using online teaching-learning process, we cannot explain in an effective manner. While solving for example, teachers require no. of formulas, some of students do not remember some formulas that time the teacher teaches repeated formulas, but in online teaching there are limitations to teachers. Therefore students as well as teachers are also not satisfied with online teaching-learning process. Online teaching is like a one-way process, teacher teaches and students hear all this.

Due to continuous disturbance in the network, students connected to online class and out from online class. Due to this students are not getting lectures in a continuous way therefore students are not comfortable so that attendance in online class is not constant, it varies day to day. As compared to offline classes, attendance in online lectures is very poor. It is not the fault of students as well as

teachers . It is the fault of the weather, the network, and the situation. Due to this all are suffering from such a situation .

Most of the students are from poor families therefore they cannot afford the Android Mobiles or electronic Gazette therefore there is a lot of disturbance in their study due to electronic gazettes. In offline class students have their notebook , they can easily write their notes on note books but in online teaching some teachers upload videos and notes on drive and provide links to students but it is not possible for every student to download each lecture. Due to the size of the video it is not possible to download it. Therefore there are more difficulties seen from the students ' side. Videos are uploaded by teachers but students are not getting these videos due to size of videos and also pdf having small sizes. Students are not getting maths concepts in a clear manner therefore it is a very difficult task for students also.

Conclusion :

Due to Covid 19 Pandemic , the whole education system changed, impact of covid 19 is seen on teaching learning Mathematics Education. Online education has advantages as well as Disadvantages. As we compare between offline and online Mathematics Education , it is found that offline Mathematical education is effective, suitable, more interactive,

Bibliography

- Burgess, S., & Sievertsen, H. H. (2020, April 1). *Schools, skills, and learning: The impact of COVID-19 on education*. Retrieved April 1, 2020, from <https://voxeu.org/article/impact-covid-19-education>:
<https://voxeu.org/article/impact-covid-19-education>
- Pokhrel, S., & Chhetri, R. (2021). A Literature Review on Impact of COVID-19 Pandemic on Teaching and Learning. *SAGE journals*, 8(1), 9.

60. Interdisciplinary Approach of Graph Theory

National conference On
Graph Theory And It's Application (NCGTA-2018)
New Art's Commerce And Science College, Parner
INDIA 19-20, Jan.2018 ISBN-978-81-930155-0-9

Interdisciplinary Approach of Graph Theory

Mrs. Rani Dadabhau Sonawane

Asst. Prof. Department of Mathematics
N.A.C.S. College , Parner, Dist.-Ahmednagar-414302
rdsyr13@gmail.com

Abstract:

In general , graphs theory has a wide range of application in diverse fields's. computer Science and Engineering fields have many situations where a knowledge of graph theory is needed . This paper aims to emphasize the applications of graph theory in daily life and technologies computer Science, operation Research , Chemistry, etc.

Keywords: Computer Science , Operation Research , Chemistry etc.

Introduction:

Graph theory is a branch of discrete mathematics. In mathematics and computer science, graph theory is the study of graphs which are mathematical structures used to model pair wise relations between objects. There is wide use of graphs in providing problem solving techniques, because it gives an intuitive manner prior to presenting formal definition. Graphs provide a convenient way to represent various kinds of mathematical objects. Essentially, any graph is made up of two sets: 1- A set of vertices 2- A set of edges. Depending on the particular situation, restrictions are imposed on the type of edges we allow. For some problems directed edges are applied and for other problem undirected edges are applied from one vertex to other. So graphs give us many techniques and flexibility while defining and solving a real life problem.

Material and Methods :

Most of the student ignore about the application of Graph theory in Various fields. By using Group Discussion, internet, collectively get the awareness of Interdisciplinary approach of graph theory.

Result:

Data base designing In data base designing graphs are used as graph data bases [1]. Graph database uses graph representation with nodes, edges, and properties to represent and store data. This graph structure has key role in designing database, because it gives fast implementation process using different functionality and properties of graph structure .Graph database uses as: → Storage system that provides index free adjacency → Analyzing tool for interconnection → Powerful tool for graph like-query → Graph databases are often faster for associative data sets that map more directly to the structure of object-oriented applications.

Software engineering Graph has many applications in software engineering. For example: during Requirements Specification, Data Flow diagrams are used where vertices represent transformations and edges represents the data flows. During Design phase, graphical design is used for describing relations among modules; while during Testing, the control flow of a program associated with

National conference On
Graph Theory And It's Application (NCGTA-2018)
New Art's Commerce And Science College, Parner
INDIA 19-20, Jan.2018 ISBN-978-81-930155-0-9

McCabe's complexity measure which employs directed graphs for addressing the sequence of executed instructions and etc. Even Software Process Management has also applications of network diagrams which involves graph algorithms.

Network system Graph theory has wide application in the field of networking. To analyze the graph theory application in networking two areas are considered: graph based representation and network theory. Graph based representation has many advantages such as it gives different point of view; it makes problem much easier and provide more accurate definition. Whereas network theory provide a set of techniques for analyzing a graph and applying network theory using a graph representation. The term graph and network are equal. Both refer to a type of structure in which there exists vertices (i.e. nodes, dots) and edges (i.e. links, lines). There are numerous types of graphs and networks which yield more or less structure.

Operating system A graph is a data structure of finite set of pairs, called edges or vertices. Many practical problems can be solved with the help of graph in the field of operating system such as job scheduling and resource allocation problems. For example graph coloring concept can be applied in job scheduling problems of CPU, jobs are assumed as vertices of the graph and there will be an edge between two jobs that cannot be executed simultaneously and there will be one to one relationship between feasible scheduling of graphs .

Website designing Website designing can be modeled as a graph, where the web pages are represented by vertices and the hyper links between them are represented by edges in the graph. This concept is known as web graph. Which discover the interesting information? Other application areas of graphs are in web community. Where the vertices represent classes of objects, and each vertex representing one type of objects, and each vertex representing a type of object is connected to every vertex representing other kind of objects. In graph theory such a graph is called a complete bipartite graph.

REFERENCES:

[1] Designing Graph Database Models from Existing Relational Databases by Subhrajyoti Bordoloi Bichitra Kalita Dept. Of Computer Applications Dept. Of Computer Applications Assam Engg. College, Guwahati, Assam Engineering. College, Guwahati, Assam.(International Journal of Computer Applications (0975 -8887), Volume 74, no-1,July 2013)

61. Application Of Number Theory In Computing/ Cryptography

Application of Number theory in computing/cryptography

Komal Pawar

Department of Mathematics, New Arts Commerce and Science college, Parner.

Abstract:

The number theory, as such, is less applied in engineering compared to calculus, geometry, etc. But, the number theory, combined with the computational power of modern computers, gives interesting solutions to real-life problems. The number theory is a branch of mathematics which is primarily dedicated to the study of integers. It has many uses in various fields such as cryptography, computing, numerical analysis and so on. The problem was that it could not be used directly in any application.

With recent advancement in computation, the field of Number Theory is expanding its domains of applicability from beyond theoretical results to real life applications in the various fields of Technology. We have also touched upon various theorems used for the verification and generation of primes and the uses of modulus operator in this field. It's a fundamental tool which forms the basis of modern cryptography techniques forming the base line for Key Generation used to secure connections nowadays.

Keywords: Cryptography, computation, authentication, numerical analysis

References:

- [1] Number Theory: Cryptography Introduction
(<https://www.youtube.com/watch?v=2sQ47YSmY9I>)
- [2] <https://www.encyclopedia.com/science/encyclopedias-almanacs-transcripts-and-maps/applications-number-theory-cryptography>

62. Application of Operational Research To The Transportation Problem

Applications of Operational Research to the Transportation Problems

Asst. Prof. Nutan T. Mandge

Department of Mathematics, New Arts Commerce and Science College, Parner.

Abstract: Development and Transportation Transport, which links people to resources and markets and gives them access to jobs, health, education and other amenities, is crucial to development. The literature on transportation and development reflects two divergent types of opinions. While one school of thought emphasizes that investment in social overheads should be done in anticipation of future needs rather than as an outcome of capacity shortages, the other school emphasizes need-based investments. The first school of thought assumes that advance investments would give rise to infrastructure facilities and would act as a catalyst to accelerate the process of development through external economies. The second school tries to reduce the risks and uncertainties involved in long-term investments. It is necessary to analyse whether there is a causal relationship between development and transport capacity. This would help in determining the optimum level of investment required in transportation in relation to other sectors of the economy.

Keywords- Linear, integer, mixed-integer, network and simulation models, linear and goal programming models.

References

1. Anand, S., C.S. Arora and M.K. Mohan. 1981. 'Slurry Transportation—A New Concept in Coal Management', in N.K. Jaiswal (ed.), *Scientific Management of Transport Systems*, pp. 77-83. Selected papers presented at the International Conference on Transportation held in New Delhi during 26- 28 November 1980, organised by IFORS and ORSI, North Holland.
2. Assad, A.A. 1981. 'Analytical Models in Rail Transportation: An Annotated Bibliography', *INFOR*, 19(1): 59-80.
3. Bandurka, A.A. 1979. 'Transport for Health in Rural Ghana', Unpublished M.Sc. thesis. University of Sussex.
4. Bonett, A.M., and R.B. Brito. 1973. 'A Model for the Evaluation of Transport Alternatives', *Bulletin of Mexican Institute of Planning and Operation of Systems*, 20(1): 21-38.

63. Application Of Computational Geometry

Applications of Computational Geometry

Asst.Prof. Gadhve V.C.

Department of Mathematics ,New Arts Commerce And Science College, Parner.

Abstract--

Computational geometry is an integral part of mathematics and computer science deals with the algorithmic solution of geometry problems. From the beginning to today, computer geometry links different areas of science and techniques, such as the theory of algorithms, combinatorial and Euclidean geometry, but including data structures and optimization. Today, computational geometry has a great deal of application in computer graphics, geometric modeling, computer vision, and geodesic path, motion planning and parallel computing. The complex calculations and theories in the field of geometry are long time studied and developed, but from the aspect of application in modern information technologies they still are in the beginning. In this research is given the applications of computational geometry in polygon triangulation, manufacturing of objects with molds, point location, and robot motion planning.

Keywords--

Computer graphics, triangulation of polygon, linear optimization, point location and motion planning.

Reference--

- 1- Akl, S., "A constant-time parallel algorithm for computing convex hulls," BIT, vol. 22, 1982, pp. 130-134.
- 2-Akl, S., The Design and Analysis of Parallel Algorithms, Prentice Hall, Englewood Cliffs, New Jersey, 19
- 3-Minsky, M. and Papert, S., Perceptrons: An Introduction to Computational Geometry, M.I.T. Press, 1969.

64. Uses Of Graph Coloring In Day To Life.

Uses of Graph Coloring in day to day life.

Asst. Prof. Dhanashree Kaware

Department of Mathematics, New Arts Commerce and Science College Parner.

Abstract :

Graph Theory is to be wide subject with simple ideas of geometry and has powerful applications in Computer Science, Chemistry, Biology, Physics, Mathematics, Engineering, Road Construction and day to day life etc.

Bipartite graph is one of the type of graph. Bipartite graph is simple graph. The studies of bipartite graph and coloring may yield a lot of application in day to day life. The minimum number of color is called the chromatic number $\chi(G)$. In this paper, a day to day life uses of graph coloring in bipartite graph are discussed.

Keywords:

Graph, Bipartite graph, Vertex coloring, Edge coloring.

References:

1. Dr. Natarajan Meghanathan, Review of Graph Theory Algorithms, Department of computer Science, Jackson State University, Jackson, MS39217.
2. http://en.wikipedia.org/wiki/Graph_coloring.

65. Application Of Number Theory In Statistics

Applications of Number Theory in Statistics

Asst.Prof. Supriya S. Raskar

Department of Mathematics ,New Arts Commerce And Science College, Parner.

Abstract-- There have been several fascinating applications of Number Theory in Statistics. The purpose of this survey paper is to highlight certain important such applications. Prime numbers constitute an interesting and challenging area of research in number theory. Diophantine equations form the central part of number theory. An equation requiring integral solutions is called a Diophantine equation. In the first part of this paper, some problems related to prime numbers and the role of Diophantine equations in Design Theory is discussed. The contribution of Fibonacci and Lucas numbers to a quasi-residual Metis design is explained. A famous problem related to finite fields is the Discrete Logarithm problem. In the second part of this paper, the structure of Discrete Logarithm is discussed.

Keywords--- Distribution of Primes, Diophantine Equations, Design, Fibonacci and Lucas Numbers, Discrete logarithm Problem

References

- [1] G.H. Hardy and E.M. Wright, "An introduction to the theory of numbers", Oxford University Press, London, 1975.
- [2] A. Hoffman, "Statistical investigation of structure in the discrete logarithm", Rose-Hulman Undergraduate Mathematics Journal, Volume10, Issue 2, Pp. 1 – 20, 2009
- [3] L.J. Mordell, "Diophantine equations", Academic Press, London, 1969

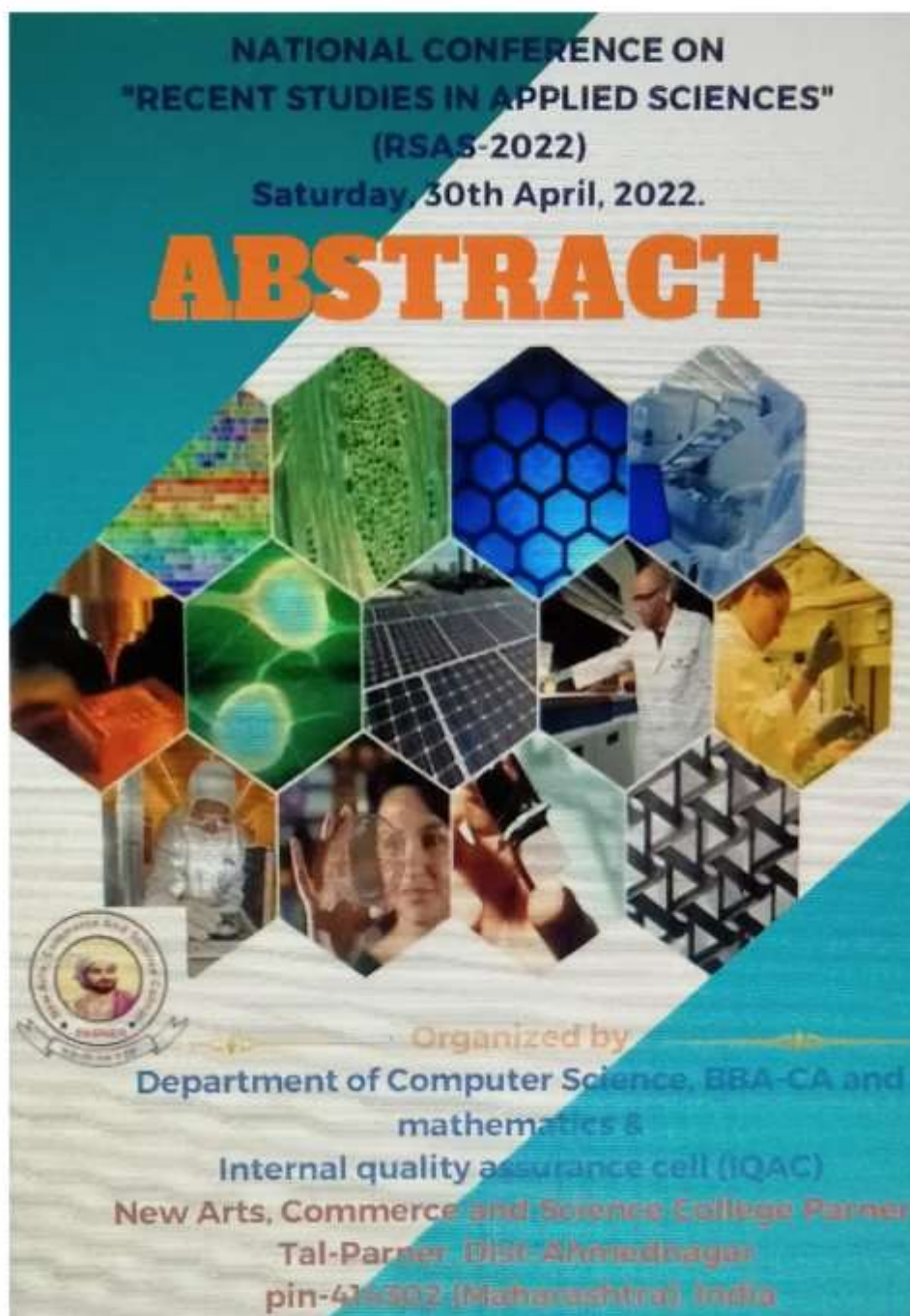
66. Secure Home doorbell using python and raspberry PI

SECURE HOME DOOR BELL USING PYTHON AND RASBERRY PI

S. P. Gaikwad, Assistant Professor,

Department of Computer Science,

New Arts Commerce and Science College, Parner (MH)

Authors Email: spr79589@gmail.com

Abstract:

Security is the main concern in the current world. Recently there are many security systems are developed for securing Home, offices and Personal Properties. The security system includes camera, fingerprint identification, RFID and sensors. In all this security system camera face recognition system is most common, it takes less time for implementation and installation.

In this work, a system is implemented that recognise the family members of the home by face recognition and rang a simple bell. Whereas when the unknown person detected by the system then the system rang a different bell and shows the face in the system display. The system also send Authors Email to the home owner. The process is performed automatically without human help. In this system, the raspberry microcontroller installed with Open CV & Face recognition library, the raspberry pi camera module is connected for face recognition and bell is connected to Raspberry microcontroller. The data of the persons is stored in the memory card which is connected to the Raspberry Pi. The result shows that it feels secure while opening the door for the persons and alerts home owner.

Keyword: face recognition, Open CV, Bell, E-mail

Introduction:

The current system rang different bell works on face detection and identification. Generally, the door is opened by looking through door hole but it is quite risky. Hence it is necessary to develop such system that identify the difference between the family members and the unknown person. This system also sends the Authors Email to the home owner so any accidental situation happened then it helps for investigation. The Raspberry Pi uses Open command Visualization (Open-CV) and the Face recognition library in used in which Source code is open and which is used for image processing. The main aim of this system is to feel free and secure for the door Opener.

Literature Survey:

Many Companies providing the home security system that includes various sensor network, network devices and it automatically increases the cost and Power requirement. These system takes more time for installation.

The face detection has been implemented using a method called Histogram of Oriented Gradients.

The Existing system using smart doorbell using raspberry pi send SMS and Authors Email notification to the person in the home.

The existing system of IOT based smart doorbell send video call when someone presses the door bell as well as send an SMS.

In above systems the internet to be continuously on but current system works well without internet.

Hardware Description

The hardware of the current system is basically consisting of Raspberry pi, Camera module, bell, network device(switch).

Raspberry pi board:

The raspberry pi 3 accept the input from the camera, then raspberry pi identifies the person and sending the signal to bell and send the Authors Email to the home owner through the switch.

Specification of Raspberry Pi:

1. Broadcom BCM2837 64bit Quad Core Processor 1.2 GHz
2. RAM: 1Gbytes DDR2
3. Bluetooth: 4.1 LE
4. WIFI



Camera Module:



face detected by using of the camera module. It is Raspberry Pi Camera Module with Automatic IR-Cut Night Vision Camera 5MP 1080p HD Webcam for Raspberry Pi 3 Model. It's easily affordable to any inventor for camera projects.

Software Description:

Write the code for the hardware it's required a Linux terminal.

The capture image, its recognition all command written in the Linux terminal. Linux command is:

- Sudo apt-get update = to update the raspberry pi 4.

- Cd /home/pi/Desktop = To use the open file its located on the desktop.
- Sudo apt-get install rpi.gpio = To install a require library for the GPIO pin.
- sudo apt install python3-opencv
- pip3 install face_recognition
- Python face.py = To run the source code.

Proposed Model

The Proposed system is used for home security by using face detection and bell. The system block diagram consists of Camera module attached to the raspberry pi3 and it is placed at the entry of the home. Camera is used to detect the face of the person next to the door.

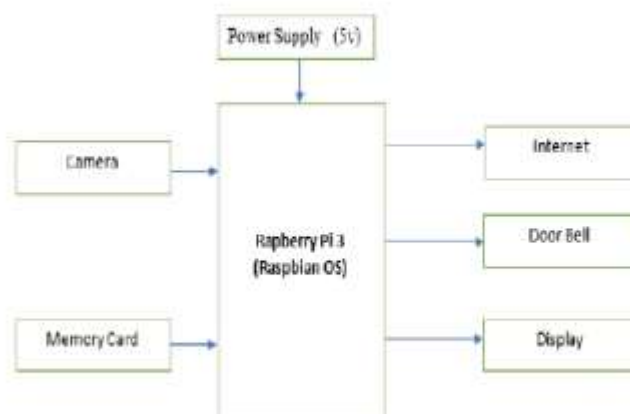

The face of the person is recognized and compare with the face of the family which is stored in the databases through library file present in the Open CV and face recognition. Face recognition is simple and effective method.

The process of face recognition and bell as follows

1. Image from Camera:

The camera is installed in the area where people enter through door. The camera collects the images as well as video from the camera. The collected images is used for face recognition.



2. **Creating and verifying the image in the databases:**

The image of family member with name is stored in the databases. The database contains the five to six sample of images of each family members with different lighting situation.

3. **Detecting faces:**

There is different algorithm is present in the Open CV library Here we have to detect the face in real time so Haar cascade Algorithm is used because it is Robust.

4. **Face Recognition:**

The detected face is compared with the images stored in the databases. The accuracy of image detection is increased by comparing with 30-40 images. The distance from camera to face is also critical while recognition and it is found that ideal distance is 2-6 meters.

5. **Bell:**

After the face is detected if the person is family member, then Raspberry Pi send the signal to the bell to sound for simple bell and if the person detected is unknown then bell rang differently to indicate new person.

6. **Authors Email:**

If the identified person is unknown then Raspberry pi send the Authors Email to the house owner which helps for security and in accidental situation.

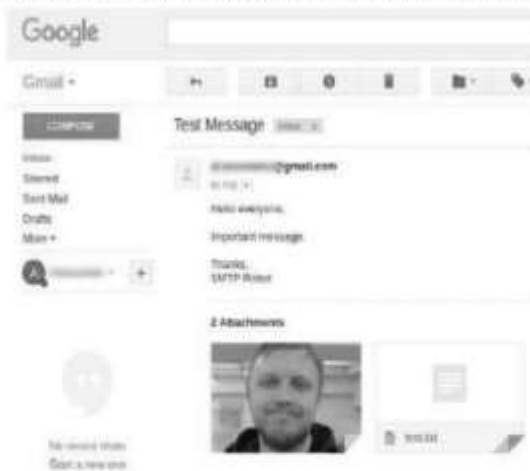

Conclusion:

Secure Home Bell system prove the system is robust, safe, cheap, accurate and easy to install. In real time Scenario, the haar cascade algorithm is suitable for work.

Raspberry Pi improves the mobility of the setup and debugging. The work can be improved by night vision camera and HD camera.

References:

1. Ruian Liu Mimi Zhang Shengtao Ma, "Design of Face Detection and Tracking System", 2010 IEEE 3rd International Congress on Image and Signal Processing
2. Rafael C. Gonzalez. 2009. Digital Image Processing. Pearson Education India.
3. Yi-Qing Wang. 2014. An Analysis of the Viola-Jones Face Detection Algorithm. Image Processing on Line. 4: 128-148.
4. Harshal V. Khodaskar, Shashank Mane "Human Face Detection & Recognition Using Raspberry Pi" International Journal of Advanced Engineering, Management and Science ISSN: 2454-1311.
5. Shrutika V. Deshmukh, Prof Dr. U. A. Kshirsagar "Face Detection and Face Recognition Using Raspberry Pi", International Journal of Advanced Research in Computer and Communication Engineering, Vol. 6, Issue 4, April 2017

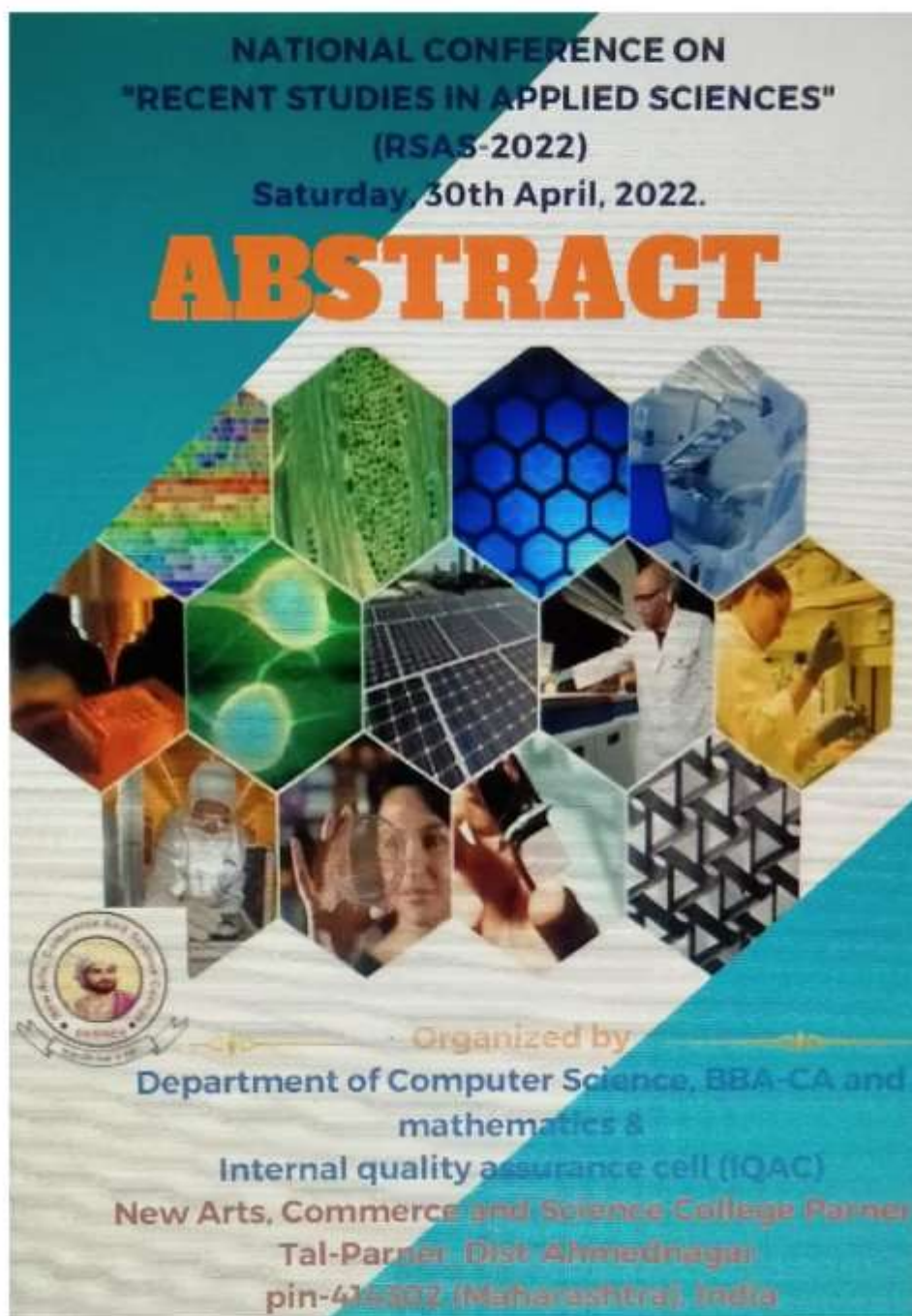
67. Role of Artificial Intelligence in Human Computer Interaction

ROLE OF ARTIFICIAL INTELLIGENCE IN HUMAN COMPUTER INTERACTION

Mr. Amol Popatrao Wabale

Department of Computer Science

New Arts, Commerce & Science College, Parner

Abstract

There is a deeper contrast in AI & HCI. The ultimate goal of both fields is to make UI. More effective & easier for a person to use. AI was generally marked by a very ambitious long term vision requiring expensive systems. The situation today is much more promising in part because of platform convergence. AI can be exploited on widely used systems. This paper focuses on the methodologies regarding interaction of AI with HCI.

Keywords: Artificial Intelligence, Human Computer Interaction, User Interface.

I. Introduction

Research in Human-Computer Interaction (HCI) has been spectacularly successful, and has fundamentally changed computing. HCI depends upon electronic devices and component. Just one example is the ubiquitous graphical interface used by Microsoft Windows 95, which is based on the Macintosh, which is based on work at Xerox PARC, which in turn is based on early research at the Stanford Research Laboratory (now SRI) and at the Massachusetts Institute of Technology. HCI is in some measure a kind of Applied Cognitive Science, applied to interaction between people and computer hardware & software as we have it today. Commands, Questions & Answers, Menus, Form Filling, Function keys, Graphical Direct Manipulation are the styles of the HCI. HCI is, in some measure, a kind of "Applied Cognitive Science", applied to the interaction between people. and computer hardware and software as we have it today.

II. HCI Goals, AI Opportunities

From the earliest times in the development of computers, activities in the field of Human-Computer Interaction (HCI), and Artificial Intelligence (AI) have been intertwined, AI and HCI have always had a love-hate relationship. The goal of Human-Computer Interaction is to make computers easier to use and more helpful to their users. The goal of Artificial Intelligence is to model human thinking and to embody those mechanisms in computers. Also offer maximum flexibility, Facilitate error connection, Facilitate command remembering.

The "Small size of infinity" and "Disappearing AI"

The "small size of infinity" refers to the looking at a major AI problem, like natural language understanding, or speech recognition, collecting human common sense knowledge; it is easy to get discouraged. The "disappearing, A problem is that, as soon as AI achieves a success, that success is assimilated into the application domain, and so AI, as a field, finds it difficult to claim credit for the success.

Taming the savage beast of AI

Many AI projects do suffer from poor user interface design which user interfaces to AI systems are put together by people whose main interest is working on the details of a learning algorithm rather than the interface itself can lead to poor results in user tests. But one of the best reasons for AI to pay more attention to HCI is that it will result in improving the science of AI itself. After all AI is trying to imitate human reasoning, so shouldn't we study people, the best example we have so far of intelligent systems, to see how it works in practice? HCI's "feedback loop" of observing users designing systems around their needs and behavior then testing them with users provides a great test bed for discovering the principles behind the intelligent problem solving to achieve with AI systems.

III. Challenges in HCI design for AI applications

Because AI systems may contain complicated decision-making algorithms, such as learning or inference, they pose special problems for interface design, which are absent, or less serious, for more conventional tool-based interfaces. The underlying complexity of AI algorithms means that interface design needs to pay special attention to transparency and explanation. Since complex algorithms might indeed be "smarter than the user", in order for users to develop trust in the program, they have to be able to understand it at some level (if not fully. Self-awareness and reflection in programs deserves more emphasis when AI meets the user interface. Explanation generation and more of what AI has learned in this area needs to be mobilized for effective AI interfaces. Visualization techniques in HCI serve as a nice complement, and also increase the level of understanding that users have of the operation of a program.

Graphical direct manipulation interfaces were a big advance because they allowed users to provide input and receive output from systems by making use of real-world metaphors icons representing files, etc. The kind of input and output most natural for people is that which engages their natural ability to sense and interact with the world. Some HCI projects have felt "burned"

by overambitious AI claims to be able to interpret unconstrained natural language or visual input, any such systems eventually didn't test well in practice.

IV. Integrating AI Into interfaces

In summary, we think the future is bright for integrating AI into user interfaces, combining the best of user-centered design with the representation, reasoning and recognition that AI has to offer. A recent development in the AI community is that more and more of AI software is being packaged into easily interruptible toolkits that make it easier for interface implementers to experiment with AI capabilities.

V. Conclusion

It is clear that all of the most important innovations in Human-Computer Interaction have benefited from research at both corporate research labs and universities, much of it funded by the government. The conventional style of graphical user interfaces that use windows, icons, menus and a mouse and are in phase of standardization, where almost everyone is using the same, standard technology and just making minute, incremental changes. Therefore, it is important that university, corporate and government-supported research continue, so that we can develop the science and technology needed for the user interfaces of the future with the help of or using AI techniques.

References

1. Terry Winograd, Stanford University, 353 Serra Mall, Stanford, CA, USA
Available online 1 November 2006
2. AI Articles, Association for the Advancement of Artificial Intelligence. All rights reserved. ISSN 0738-4602.
3. Gaines, B. R., and Shaw, M. L. G. 1985. From Timesharing to the Sixth Generation: The Development of Human-Computer Interaction, Part I. *InterState Level Journal of Man-Machine Studies* 24(1): 1-27.
4. AI Magazines.
5. Journals of AI and its application.

* * *

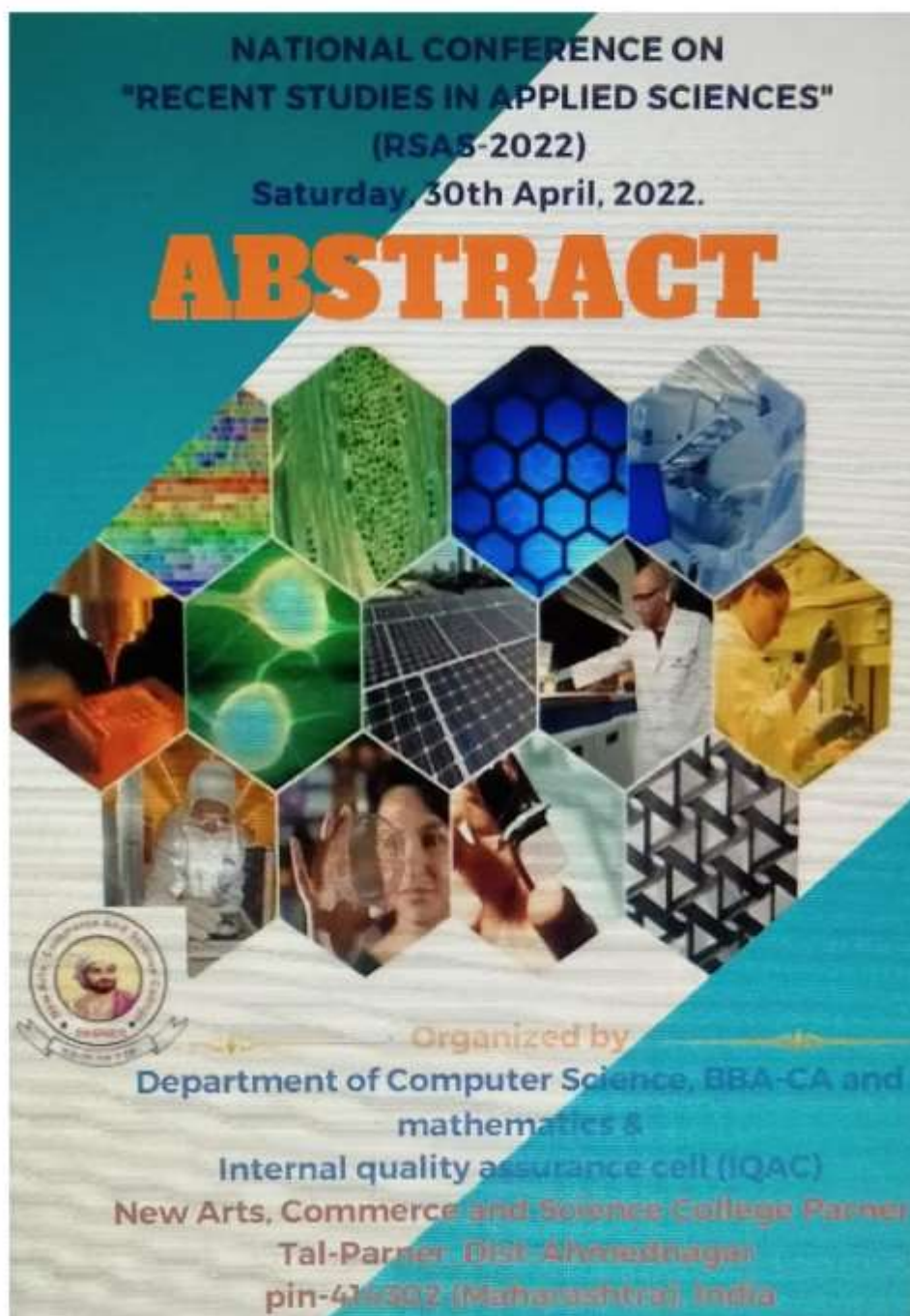
68. Multitank Drone Spray using AI

MULTI-TANK DRONE SPRAYER USING ARTIFICIAL INTELLIGENCE

Mr. Nilesh Bala. Sobale

Department of Computer Science

New Arts, Commerce and Science College, Parner

Abstract:

Artificial intelligence is Divided into two component. Firstly, it involves the study of how human being thinks. Secondly it deals with the representation of human thought via Machines.

Disease Diagnosis with AI predictions, farmers can get knowledge of diseases easily.

With this, they can easily diagnose diseases with proper strategy and on time. It can save the life of plants and farmer's time. To do this, firstly, images of plants are pre-processed using

computer vision technology. This ensures that plant images are properly divided into the diseased and non-diseased parts. After detection, the diseased part is cropped and sends to the labs for further diagnosis. This technique also helps in the detection of pests, deficiency of nutrients, and many more.

With AI sensors, weed can be detected easily, and it also detects weed affected areas, insects affected area, fungus affected area. On finding such areas, herbicides, fungicide, pesticide can

be precisely sprayed to reduce the use of herbicides, fungicide, and pesticide also saves time and crop. For that we are used multi-tank drone spray, we fill herbicide, pesticide, and fungicide in separate different tank and we can control multi-tank drone through Artificial Intelligence Program Module / AI Remote control and spray affected area through respective diseases that means fungicide sprayed on fungicide affected area, Herbicides on weeds affected area, insecticides sprayed on insecticide affected area automatically according to crop disease.

There are different AI companies that are building robots with AI and computer vision, which can precisely spray on weeds. The use of AI Multi-tank sprayers can widely reduce the number of chemicals to be used on fields, and hence improves the quality of crops and also saves money.

Challenges in Agriculture using Traditional Methods

- o In farming, every day climate factor will be changes such as Rainfall, temperature, and humidity play an important role. Due to pollution, sometimes climate varies suddenly, and hence it becomes difficult for farmers to make proper decisions for harvesting, sowing seeds, and soil preparing.
- o For a better crop, it is necessary that the soil should be productive and have the required appropriate fertilizers, such as Nitrogen, Phosphorous, and Potassium. If these fertilizers are not use appropriate in the soil, then it may lead to poor quality crops. But it is difficult to identify this soil-quality with traditional ways.
- o In the agriculture lifecycle, it is required that we save our crops from weeds. Else it may increase the production cost, and it also absorbs nutrients from the soil. But by traditional ways, identification and prevention of crop from weeds is not efficient.



As with the traditional methods of Agriculture, there are lots of challenges that farmers are come to farmer. To solve these challenges, AI is being widely used in this sector.

For agriculture, Artificial Intelligence has become a revolutionary technology. It helps the farmers by producing healthier crops, control pests, soil monitoring, and many more ways.

Some key applications of Artificial Intelligence in the Agriculture sector:

1. **Whether and price guessing:**
In this farmer should have knowledge about changing environment and better price of our product on time when we are sale in market. with the help of AI weather forecasting, farmers can have information on weather analysis, and accordingly, they can plan for the type of crop to grow, seeds to sow, and harvesting the crop. With price forecasting, farmers can get a better idea about the price of crops for the next few weeks, which can help them to get maximum profit.
2. **Health Monitoring of Crops :**
Health of crop depends on the quality of soil. Fertilizers that we are used for crops and water management, in that which crop will required haw many water, or over limits of use of chemical fertilizers decreases quality of soil and it is difficult to determine.

There are many application using AI are available for guide to farmer, Like Actionable weather forecasts, Kisan Diary, Market Engagement , Loop, Satellite Yield Estimation. AI has come up with a new application called Plantix. It was developed by PEAT to identify the deficiencies in soil, including plant pests and diseases. With the help of this application, farmers can get an idea to use better fertilizer which can improve the harvest quality. In this app, AI's image recognition technology is used by which farmers can capture the images of plants and get information about the quality.

3. **Agricultural Robotics Machine :**

Robotics Machine is being widely used in different sectors, like Harvesting and picking, Weed control, Autonomous mowing, pruning, seeding, spraying and thinning, Phenotyping, Sorting and packing, utility platforms mainly perform complex tasks. Nowadays, different AI companies are developing robots to be employed in the Agriculture sector. These AI robots are developed in such a way that they can perform multiple tasks in farming. AI robots are also trained in checking the quality of crops, detect and controlling weeds, and harvesting the crop with faster speed compared to a human.

4. **Intelligently Spraying Pesticides and Insecticides :**

With AI sensors, weed can be detected easily, and it also detects weed affected areas, insects affected area, fungus affected area. On finding such areas, herbicides, fungicide, pesticide can be precisely sprayed to reduce the use of herbicides, fungicide, and pesticide also saves time and crop. For that we are used multi tank drone spray, we fill herbicide, pesticide, and fungicide in separate different tank and we can control multi-tank drone through Artificial Intelligence Program Module / AI Remote control and spray affected area through respective diseases that means fungicide sprayed on fungus affected area, Herbicides on weeds affected area, insecticides sprayed on insecticide affected area automatically according to crop disease. There are different AI companies that are building robots with AI and computer vision, which can precisely spray on weeds. The use of AI Multi-tank sprayers can widely reduce the number of chemicals to be used on fields, and hence improves the quality of crops and also saves money.

5. **Disease Diagnosis With AI predictions,** farmers can get knowledge of diseases easily. With this, they can easily diagnose diseases with proper strategy and on time. It can save the life of plants and farmer's time. To do this, firstly, images of plants are pre-processed using computer vision technology. This ensures that plant images are properly divided into the diseased and non-diseased parts. After detection, the diseased part is cropped and sends to the labs for further diagnosis. This technique also helps in the detection of pests, deficiency of nutrients, and many more.

6. **Precision Farming**

Precision farming is all about "Right place, Right Time, and Right products". The precision farming technique is a much accurate and controlled way that can replace the labour-intensive part of farming to perform repetitive tasks. One example of Precision farming is the identification of stress levels in plants. This can be obtained using high-resolution images and different sensor data on plants. The data obtained from sensors is then fed to a machine learning model as input for stress recognition.

Traditional Drone Sprayer:

In this traditional drone sprayer pesticide, herbicides, and insecticides are fill into one tank of drone sprayer and that are sprayed on all crops in our farming. Different types of areas are present in farm that is weeds affected area, fungus affected area and insect affected area etc. when we spraying on crop, if some area are not affected by insects then it also sprayed by the

insecticides because pesticide, herbicides, and insecticides are filled into one tank. Here those crops are not required insecticide, pesticides, herbicides that are also sprayed on forcefully.

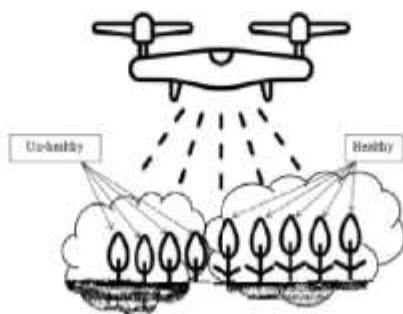

The above image shows two types of crops i.e. healthy and un-healthy that means healthy crop not required medicines but from drone all types of medicines are sprayed on it. So here is lot of wastage of crop medicines.

Multi-tank Drone Sprayer:

In this Multi-tank Drone sprayer we can use multiple tanks, Each tank filled by separate crop medicine that means insecticides filled in one tank i.e. T1, Pesticides filled on second tank i.e. T2, herbicides filled in third tank i.e. T3 and some other medicine filled in fourth tank i.e. T4.

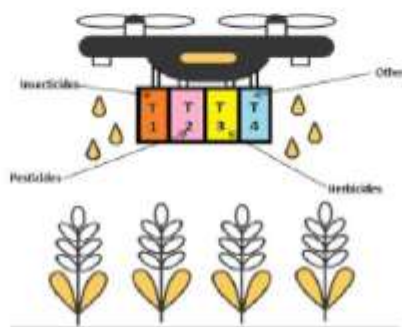

Conclusion:

The future of AI in farming largely depends on the adoption of AI solutions. Although some large-scale researches are in progress and some applications are already in the market, yet industry in agriculture is underserved. Moreover, creating predictive solutions to solve a real challenge faced by farmers in farming is still in progress at an early stage.

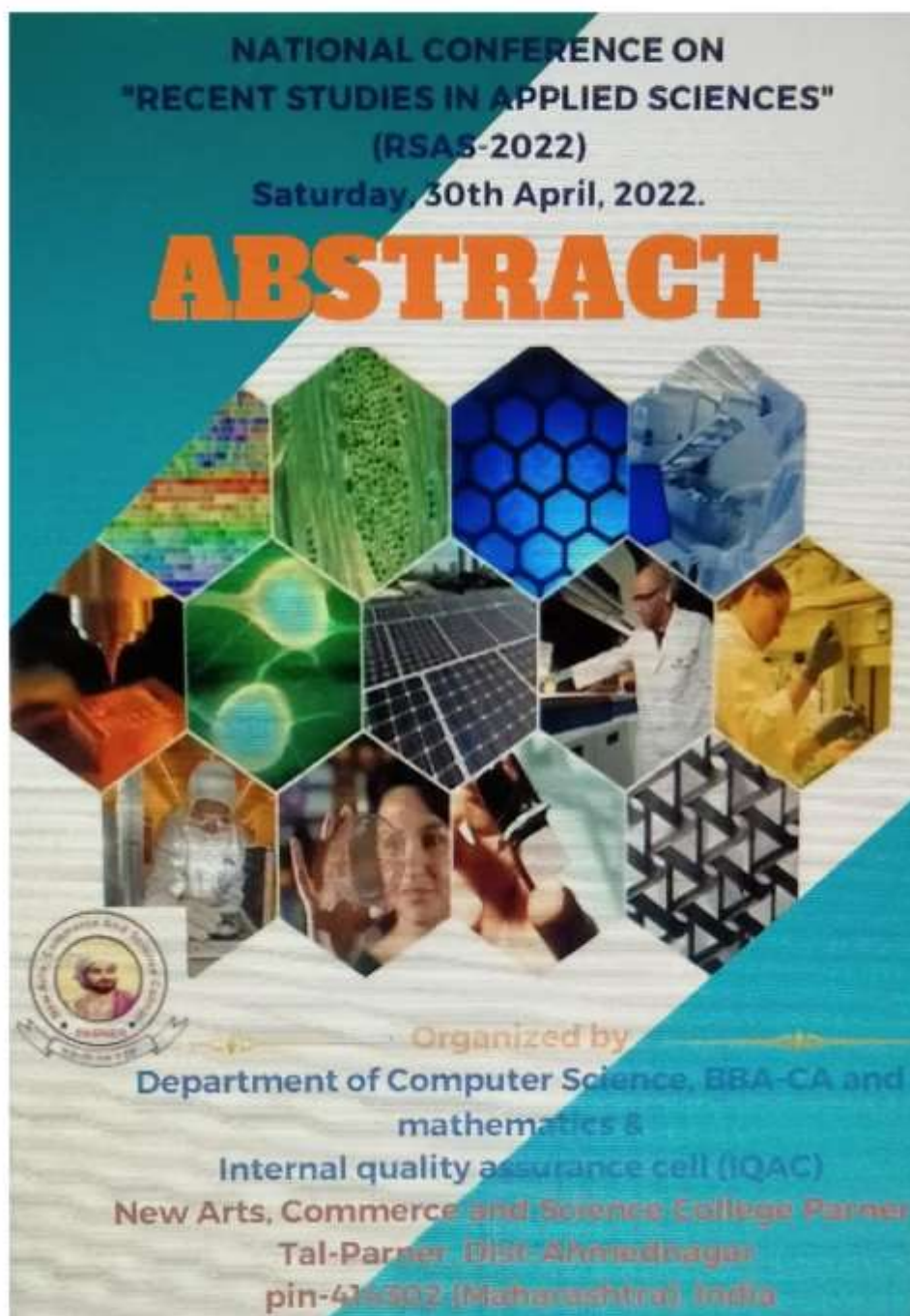
69. Online or Offline: Artificial Intelligence

ARTIFICIAL INTELLIGENCE

Priyanka B. Patade

Department of Computer Science,

New Arts, Commerce and Science College, Parner Dist. Ahmednagar – 414302 (MS).

Author's Email : priyankapatade05@gmail.com

History of Artificial Intelligence:

Artificial Intelligence was first proposed by John McCarthy in 1956 in his first academic conference on the subject. The idea of machines operating like human beings began to be the center of scientist's mind and whether it is possible to make machines have the same ability to think and learn by itself was introduced by the mathematician Alan Turing. Alan Turing was able to put his hypotheses and questions into actions by testing whether "machines can think"? After series of testing (later was called as Turing Test) it turns out that it is possible to enable machines to think and learn just like humans. Turing Test uses the pragmatic approach to be able to identify if machines can respond as humans.

Description Artificial Intelligence

Artificial Intelligence is the field of study that describe the capability of machine learning just like humans and the ability to respond to certain behaviors also known as (A.I.). The need of Artificial Intelligence is increasing every day. Since AI was first introduced to the market, it has been the reason of the quick change in technology and business fields. Computer scientist are predicting that by 2020, "85% of customer interactions will be managed without a human". This means that humans simple request will depend on computers and artificial intelligence just like when we use Siri or Galaxy to ask about the weather temperature. It is very important to be prepared for AI revelation just like UAE have by installing a state minister for AI in Dubai.

Pros and Cons of Artificial Intelligence

AI offers reliability, cost- effectiveness, solve complicated problems, and make decisions; in addition, AI restrict data from getting lost. AI is applied nowadays in most fields

whether business or engineering. One of the great tools in AI is called "reinforcement learning" which is based on testing success and failure in real life to increase the reliability of applications. Unfortunately, AI is limited with its capability and functionality.

Although Artificial Intelligence made our lives much easier and saved us more time than ever, scientists are predicting that by the huge dependency on AI humanity could extinct. Scientists argue that by having an AI machines, people will be jobless and that will conclude in losing the sense of living. Since machines are learning and doing things more efficiently and effectively in a timely manner, this could be the reason of our extinction could extinct. Scientists argue that by having a AI machines, people will be jobless and that will conclude in losing the sense of living. Since machines are learning and doing things more efficiently and effectively in a timely manner, this could be the reason of our extinction.
